

OLSA *Parts*

**CATALOGO
GENERALE 2018**



INDICE *Index*

FANALI ANTERIORI PER AUTOVETTURE <i>FRONT LAMPS FOR CARS</i>	6
FANALI LATERALI PER AUTOVETTURE <i>SIDE LAMPS FOR CARS</i>	18
FANALI POSTERIORI PER AUTOVETTURE <i>REAR LAMPS FOR CARS</i>	29
FANALI TARGA PER AUTOVETTURE <i>NUMBER PLATE LIGHTS FOR CARS</i>	70
CATADIOTTRI PER AUTOVETTURE <i>REFLECTORS FOR CARS</i>	75
PLAFONIERE PER AUTOVETTURE <i>DOME LAMPS FOR CARS</i>	78
PROIETTORI PER AUTOVETTURE <i>HEADLAMPS FOR CARS</i>	79
FENDINEBBIA PER AUTOVETTURE <i>FOG LAMPS FOR CARS</i>	84
FANALI ANTERIORI PER AUTOCARRI <i>FRONT LAMPS FOR TRUCKS</i>	88
FANALI LATERALI PER AUTOCARRI <i>SIDE LAMPS FOR TRUCKS</i>	100
FANALI INGOMBRO PER AUTOCARRI <i>SIDE MARKERS FOR TRUCKS</i>	112
FANALI POSTERIORI PER AUTOCARRI <i>REAR LAMPS FOR TRUCKS</i>	135
PROIETTORI PER AUTOCARRI <i>HEADLAMPS FOR TRUCKS</i>	184
FENDINEBBIA PER AUTOCARRI <i>FOG LAMPS FOR TRUCKS</i>	188
FANALI TARGA PER AUTOCARRI <i>NUMBER PLATE LIGHTS FOR TRUCKS</i>	192
CATADIOTTRI PER AUTOCARRI <i>REFLECTORS FOR TRUCKS</i>	197
PLAFONIERE PER AUTOCARRI <i>DOME LAMPS FOR TRUCKS</i>	201
LAMPADA ROTANTE <i>REVOLVING BEACON</i>	203
ARTICOLI VARI <i>DIFFERENT KIND OF ARTICLES</i>	208
PANNELLI SEGNALETICI <i>SAFETY DEVICES</i>	214
SPIRALI MOTRICE RIMORCHIO <i>TRAILERS SPIRAL CABLES</i>	218
RETROVISORI <i>MIRRORS</i>	222
ACCESSORI <i>ACCESSORIES</i>	234
INDICE PER CODICE <i>CODE INDEX</i>	238
RIFERIMENTI ORIGINALI <i>ORIGINAL PARTS NUMBERS</i>	250
CONDIZIONI GENERALI DI VENDITA <i>GENERAL SALES CONDITIONS TERMS</i>	270

LEGENDA *Legend*

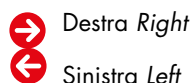

Destra *Right*

Sinistra *Left*

 Disegni e altre note a pag. 266
Drawings and other notes at page 266

OLSA PARTS è una società del Gruppo OLSA.

OLSA S.p.a. è un'azienda nata negli anni '40 del secolo scorso e dalla sua nascita è attiva nella produzione di fanaleria ed elementi di illuminazione per autoveicoli ed autocarri (fanali posteriori, plafoniere, fanali laterali, fanali targa etc.). Il quartier generale di OLSA è a Rivoli (Torino), con due stabilimenti produttivi in Italia (entrambi a Moncalieri) ed ulteriori stabilimenti in Polonia, Brasile, Cina, Messico e Turchia. Inoltre, il Gruppo ha un ufficio tecnico e commerciale in Germania.

Ad oggi, il Gruppo occupa più di 3.000 persone, di cui 650 in Italia.

In Italia, negli uffici del reparto di R&D, lavorano più di 120 ingegneri.

I Clienti del Gruppo OLSA sono tra i più importanti costruttori di autoveicoli al mondo: i principali clienti sono i produttori tedeschi, il gruppo Volkswagen (VW, Audi, Skoda, Porsche), BMW, GM e Mercedes. Oltre a questi, OLSA fornisce FCA, i produttori francesi ed i giapponesi, tra i quali Suzuki e Toyota.

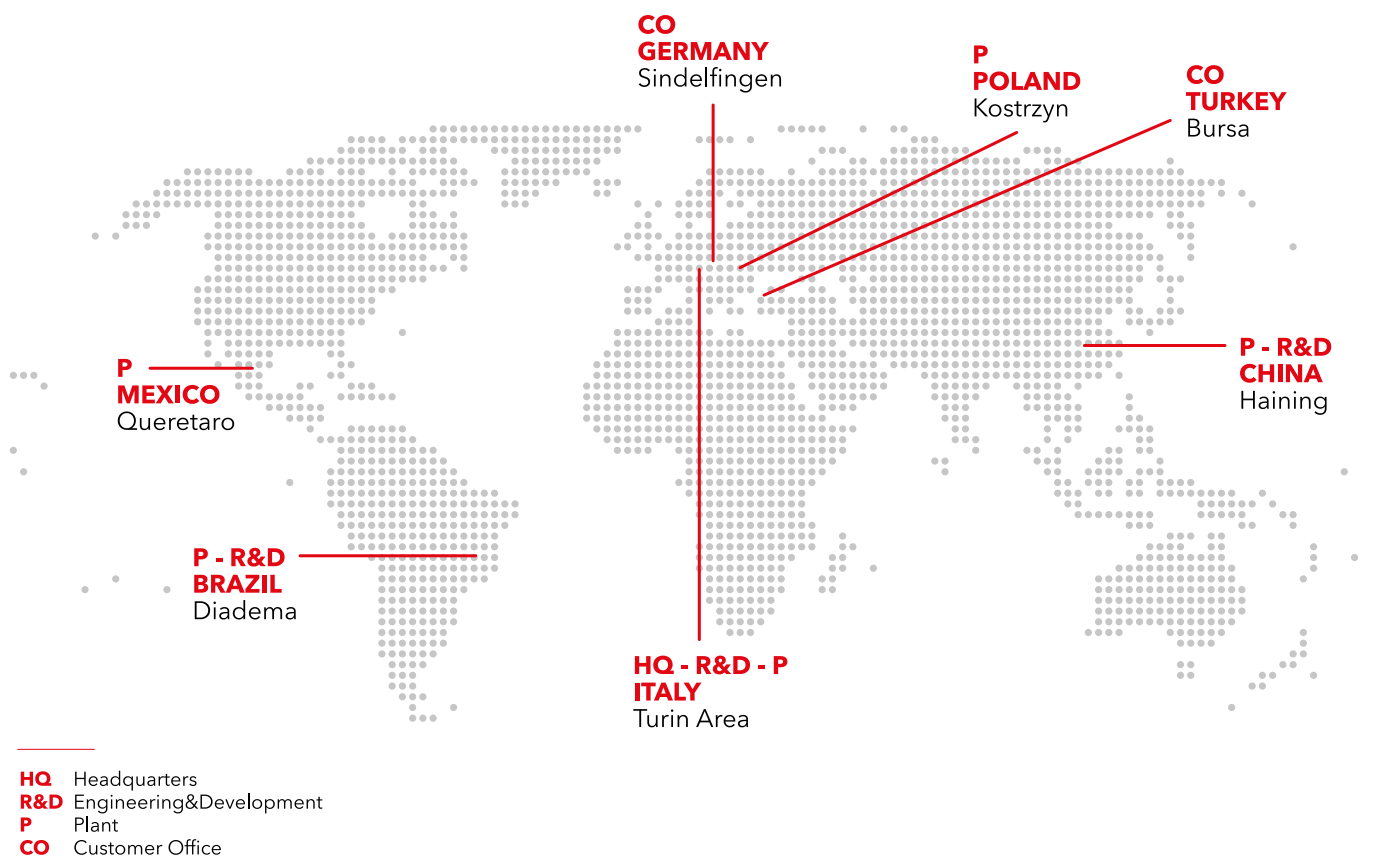
**OLSA PARTS is a company member of the OLSA Group.**

OLSA Group was born in the 40's and has been producing lighting for cars and trucks (rear lamps, dome lamps, number plate lights...) for more than 70 years. OLSA's headquarters are in Rivoli (Turin), with two production plants in Italy (Moncalieri) and others in Poland, Brazil, China, Mexico and Turkey. Moreover, OLSA also has technical and commercial offices in Germany.

As of today, OLSA Group has more than 3.000 employees of which more than 650 in Italy. In the Italian R&D department are now working more than 120 engineers.

OLSA Group's customers are among the most important car makers in the world: its main customers are in Germany, such as Volkswagen Group (with VW, Audi, Skoda, Porsche brands), BMW, GM and Mercedes. Moreover, OLSA is supplying FCA Group, the French producers and some Japanese car makers, such as Suzuki and Toyota.

IL PRESENTE CATALOGO SI PREFIGGE LA CORRETTA CLASSIFICAZIONE DELLA PARTE DI RICAMBIO NECESSARIA ALLA RIPARAZIONE DELLA VETTURA ED INDIVIDUA I PRODOTTI/ARTICOLI COMMERCIALIZZATI E DISTRIBUITI DA OLSA PARTS.

I prodotti commercializzati da OLSA Parts rientrano in tre differenti tipologie di prodotto:

- 1) Ricambio originale
- 2) Ricambio di qualità equivalente
- 3) Articoli universali

N.B.: AI FINI DEL PRESENTE CATALOGO, PER RICAMBI ORIGINALI, RICAMBI DI QUALITÀ EQUIVALENTE E ARTICOLI UNIVERSALI DEVONO INTENDERSI PRODOTTI/ARTICOLI RISPONDENTI ALLE DEFINIZIONI DI SEGUITO DATE IN CONFORMITÀ ALL'ATTUALE NORMATIVA VIGENTE IN MATERIA.

AD ECCEZIONE DEI RICAMBI ORIGINALI, LA TIPOLOGIA "RICAMBIO DI QUALITÀ EQUIVALENTE" E "ARTICOLO UNIVERSALE" – PER LA LORO ESATTA INDIVIDUAZIONE - VIENE ESPRESSAMENTE RIPORTATA IN CALCE ALLA RAPPRESENTAZIONE DEL PRODOTTO APPARTENENTE ALLE DUE SUDDETTE CATEGORIE.

SE NON DIVERSAMENTE SPECIFICATO IN CALCE ALL'ARTICOLO, COME AVVIENE PER I RICAMBI DI QUALITÀ EQUIVALENTE E ARTICOLI UNIVERSALI, IL PRODOTTO DEVE INTENDERSI "RICAMBIO ORIGINALE".

In particolare:

1) **RICAMBIO ORIGINALE:** *I ricambi originali mostrati dal presente catalogo e distribuiti da OLSA Parts, sono tutti gli articoli prodotti da OLSA Industriale, nonché ulteriori articoli prodotti da aziende diverse da OLSA Industriale.*

OLSA Industriale e le Aziende diverse dalla stessa i cui prodotti, presenti nel presente catalogo, vengono distribuiti da OLSA Parts, sono costruttori di ricambi originali conformemente alle previsioni di legge vigenti.

Si ricorda che in base alla definizione contenuta nel paragrafo 19, Titolo III, delle Linee Guida al Regolamento UE n. 461/2010, sostitutivo del Regolamento n. 1400/2002 (Legge Monti) per ricambi originali si intendono "LE PARTI O APPARECCHIATURE COSTRUITE CONFORMEMENTE ALLE SPECIFICHE E ALLE NORME DI PRODUZIONE FORNITE DAL COSTRUTTORE DEL VEICOLO. (...) SALVO PROVA CONTRARIA, SI PRESUME CHE LE PARTI COSTITUISCONO PARTI ORIGINALI SE IL COSTRUTTORE DELLE STESSE CERTIFICA CHE ESSE HANNO QUALITÀ EQUIVALENTI AI COMPONENTI UTILIZZATI PER L'ASSEMBLAGGIO DEL VEICOLO IN QUESTIONE E SONO STATE COSTRUITE CONFORMEMENTE ALLE SPECIFICHE ED ALLE NORME DI PRODUZIONE DEL VEICOLO".

2) I **RICAMBI DI QUALITÀ EQUIVALENTE** *sono espressamente indicati in calce ad ogni singolo articolo appartenente a questa tipologia* e per essi, in base alla definizione contenuta nel paragrafo 20, Titolo III, delle Linee Guida al Regolamento UE n. 461/2010, sostitutivo del Regolamento n. 1400/2002 (Legge Monti), si intendono "I PEZZI DI RICAMBIO DOTATI DI QUALITÀ SUFFICIENTEMENTE ELEVATA, IN MODO CHE IL LORO USO NON COMPROMETTA LA REPUTAZIONE DELLA RETE AUTORIZZATA IN QUESTIONE".

3) Per **ARTICOLI UNIVERSALI**, *espressamente indicati in calce ad ogni singolo articolo (a titolo esemplificativo fari lavoro, catadiottri, plafoniere, luci ingombro, pannelli riflettenti, lampade rotanti, ecc...), si intendono tutti i prodotti distribuiti e commercializzati da OLSA Parts "non appartenenti e rientranti nella categoria di ricambio originale e/o di ricambio di qualità equivalente".*

Alcuni prodotti facenti parte di tale tipologia sono soggetti ad omologazione ministeriale e/o europea necessaria all'attestazione delle loro prestazioni. **Per tali specifici articoli OLSA Parts distribuisce solo ed esclusivamente prodotti recanti le suddette omologazioni e fornisce ai clienti che ne facciano richiesta la documentazione relativa.**

LE MARCHE CITATE NEL PRESENTE CATALOGO, SONO DI PROPRIETÀ DEI COSTRUTTORI AUTO CUI SI RIFERISCONO.

IL LORO UTILIZZO NEL PRESENTE CATALOGO, COSÌ COME I RIFERIMENTI ORIGINALI INCLUSI (CROSS REFERENCES), HANNO L'UNICO SCOPO DI AIUTARE E AGEVOLARE L'IDENTIFICAZIONE DEL MODELLO D'AUTO SUL QUALE DEVE MONTARSI IL PEZZO DI RICAMBIO. PER IL CORRETTO UTILIZZO DELLE CROSS REFERENCES SI VEDANO LE "AVVERTENZE PER LA CONSULTAZIONE" AL FONDO DEL PRESENTE CATALOGO.

N.B.: NEL PRESENTE CATALOGO È INOLTRE PRESENTE UNA SEZIONE NELLA QUALE SONO RIPORTATI ARTICOLI DEFINITI "ACCESSORI". ESSI NON HANNO QUINDI LA FINALITÀ DI RISTABILIRE L'ASPETTO ORIGINARIO DEL VEICOLO MA SOLO LA FUNZIONE DI MIGLIORARE ESTETICAMENTE O MODIFICARE L'ASPETTO DEL PRODOTTO. PERTANTO TALI COMPONENTI NON DEVONO ESSERE CONSIDERATI RICAMBI BENSÌ ACCESSORI.

THIS CATALOGUE AIMS AT PROPERLY IDENTIFYING AND VERIFYING THE NECESSARY SPARE PARTS TO REPAIR THE CAR AND IDENTIFIES THE PRODUCTS/ITEMS DISTRIBUTED BY OLSA PARTS.

The products distributed by OLSA PARTS can be categorized into three different product types:

- 1) Original Equipment parts
- 2) Matching Quality spare parts
- 3) Universal parts

N.B. HEREBY DESCRIBED ARE THE DEFINITIONS OF ORIGINAL EQUIPMENT PARTS, MATCHING QUALITY SPARE PARTS AND UNIVERSAL PARTS IN ACCORDANCE WITH THE CURRENT LEGISLATION IN FORCE.

WITH THE EXCEPTION OF ORIGINAL EQUIPMENT PARTS, THE TYPE OF "MATCHING QUALITY SPARE PARTS" AND THE TYPE OF "UNIVERSAL PARTS" ARE EXPRESSLY STATED AT THE BOTTOM OF THE REPRESENTATION OF THE PRODUCT BELONGING TO THE ABOVE CATEGORIES.

IF NOT OTHERWISE INDICATED AT THE BOTTOM OF THE PRODUCT, AS IT IS FOR THE OTHER TWO TYPES, THE PARTS ARE TO BE CONSIDERED AS ORIGINAL EQUIPMENT.

In particular:

1) **ORIGINAL EQUIPMENT PARTS:** *This catalogue shows original equipment parts as distributed by OLSA PARTS which are all manufactured by OLSA Spa as well as other products, manufactured by companies other than OLSA S.p.a.* OLSA S.p.a. and the companies other than OLSA S.p.a. itself, whose products are shown in this catalogue and are distributed by OLSA PARTS, are manufacturers of original equipment parts in accordance with the law in force. Please note that according to the definition contained in paragraph 19, Title III of the Guidelines to the EU Regulation n. 461/2010, replacing Regulation n. 140/2002 (Monti Law), original equipment part means "PARTS OR EQUIPMENT WHICH ARE MANUFACTURED ACCORDING TO THE SPECIFICATIONS AND PRODUCTION STANDARD PROVIDED BY THE MOTOR VEHICLE MANUFACTURER [...] IT IS PRESUMED UNLESS THE CONTRARY IS PROVEN, THAT PARTS CONSTITUTE ORIGINAL PARTS IF THE PART MANUFACTURER CERTIFIES THAT THE PARTS MATCH THE QUALITY OF THE COMPONENTS USED FOR THE ASSEMBLY OF THE MOTOR VEHICLE IN QUESTION..."

2) **MATCHING QUALITY PARTS** *are specified at the bottom of every single item belonging to category and for them, according to paragraph 20, Title III of the Guidelines to the EU Regulation n. 461/2010, replacing Regulation n. 140/2002 (Monti Law), it is to be assumed "PARTS WITH A SUFFICIENTLY HIGH QUALITY THAT THEIR USE DOES NOT ENDANGER THE REPUTATION OF THE AUTHORIZED NETWORK IN QUESTION..."*

3) As **UNIVERSAL PARTS**, *specifically indicated at the bottom of every single product (such as work lights, reflectors, dome lamps, side markers, revolving beacons etc) it is to be intended all items distributed by OLSA PARTS "not belonging to the category of original equipment part and/or to the category of matching quality part".* Some of these products are subject to ministerial or European approval to certify their performance. **For these specific items, OLSA PARTS distributes only certified and approved parts and, on customer's request, can provide the related documents.**

BRANDS MENTIONED IN THIS CATALOGUE ARE PROPERTY OF THE CAR MAKER WHICH THEY REFER TO. THEIR USE IN THIS CATALOGUE, AS WELL AS THE OE REFERENCES INCLUDED, ARE ONLY MEANT TO HELP AND FACILITATE THE IDENTIFICATION OF THE CAR MODEL WHICH THE SPARE PARTS MUST BE FITTED TO. FOR A CORRECT USE OF THE CROSS REFERENCES, PLEASE REFER TO THE SECTION "NOTES FOR CONSULTATION" AT THE END OF THIS CATALOGUE.

N.B. IN THIS CATALOGUE THERE IS A SECTION WHICH SHOWS ITEMS WHICH ARE DEFINED "ACCESSORIES". THEY ARE NOT INTENDED TO RESTORE THE ORIGINAL APPEARANCE OF THE VEHICLE, BUT THEY ONLY HAVE THE FUNCTION TO CHANGE OR TO IMPROVE THE APPEARANCE OF THE ITEM ITSELF. CONSEQUENTLY, THESE COMPONENTS SHOULD NOT BE CONSIDERED AS SPARE PARTS BUT JUST ACCESSORIES.

lamps for cars

FANALI PER AUTOVETTURE

ALFA ROMEO		33	
	90→94	Gruppo ottico anteriore incolore <i>Front optical unit</i>	➔ 2.01.106.12
		Gruppo ottico anteriore incolore <i>Front optical unit</i>	➔ 2.01.107.12
	* Ricambio di qualità equivalente <i>Matching quality spare parts</i>		

ALFA ROMEO		145	
	94→98	Fanale anteriore <i>Front lamp</i>	➔ 2.01.108.00
		Fanale anteriore <i>Front lamp</i>	➔ 2.01.109.00
	* Ricambio di qualità equivalente <i>Matching quality spare parts</i>		

ALFA ROMEO		GT	
	03→	Fanale anteriore fumè <i>Smoked front lamp</i>	➔ 5.01.052.00
		Fanale anteriore fumè <i>Smoked front lamp</i>	➔ 5.01.053.00
	* Ricambio di qualità equivalente <i>Matching quality spare parts</i>		

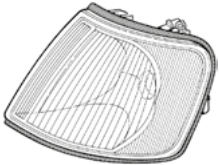
AUDI		A3	
	96→00	Fanale anteriore <i>Front lamp</i>	➔ 2.01.124.00
		Fanale anteriore <i>Front lamp</i>	➔ 2.01.125.00
		Gruppo ottico anteriore <i>Front optical unit</i>	➔ 2.01.124.12
		Gruppo ottico anteriore <i>Front optical unit</i>	➔ 2.01.125.12
	* Ricambio di qualità equivalente <i>Matching quality spare parts</i>		

CITROËN		SAXO	
	96→99	Gruppo ottico anteriore <i>Front optical unit</i>	➔ 2.01.110.12
		Gruppo ottico anteriore <i>Front optical unit</i>	➔ 2.01.111.12
	* Ricambio di qualità equivalente Matching quality spare parts		

FIAT		500 F-L	
	65→	Fanale anteriore <i>Front indicator</i>	1.01.050.00
		Trasparente anteriore arancio <i>Lens front orange</i>	1.01.050.24
		Trasparente anteriore <i>Lens front</i>	1.01.050.25

FIAT		CINQUECENTO	
	92→98	Fanale anteriore <i>Front indicator</i>	➔ 2.01.088.00
		Fanale anteriore <i>Front indicator</i>	➔ 2.01.089.00
	* Ricambio di qualità equivalente Matching quality spare parts		

FIAT		CINQUECENTO	
	92→98	Fanale anteriore <i>Front indicator</i>	➔ 2.01.090.00
		Fanale anteriore <i>Front indicator</i>	➔ 2.01.091.00
	* Ricambio di qualità equivalente Matching quality spare parts		

FIAT		500 X	
	15→	Fanale anteriore DRL <i>DRL Front lamp</i>	➔ 1.01.054.00
		Fanale anteriore DRL <i>DRL Front lamp</i>	➔ 1.01.055.00
	17→	Portalamпада con lampada coll blu <i>Bulb holder</i>	1.01.054.18

FIAT		CROMA	
	91→97	Fanale anteriore <i>Front lamp</i>	➔ 2.01.104.00
		Fanale anteriore <i>Front lamp</i>	➔ 2.01.105.00
	* Ricambio di qualità equivalente <i>Matching quality spare parts</i>		

FIAT		FIORINO	
		Fanale anteriore <i>Front indicator</i>	➔ 2.01.092.00
		Fanale anteriore <i>Front indicator</i>	➔ 2.01.093.00
	* Ricambio di qualità equivalente <i>Matching quality spare parts</i>		

FIAT		FIORINO	
	91→	Fanale anteriore <i>Front lamp</i>	➔ 2.01.128.00
		Fanale anteriore <i>Front lamp</i>	➔ 2.01.129.00
	* Ricambio di qualità equivalente <i>Matching quality spare parts</i>		

FIAT	PANDA		
	86→03	Trasparente anteriore <i>Front lens</i>	→ 2.01.066.24
		Trasparente anteriore arancio <i>Front orange lens</i>	← 2.01.067.24
	* Ricambio di qualità equivalente <i>Matching quality spare parts</i>		

FIAT	PANDA		
	86→03	Trasparente anteriore <i>Front lens</i>	→ 2.01.068.25
		Trasparente anteriore incolore <i>Front clear lens</i>	← 2.01.069.25
	* Ricambio di qualità equivalente <i>Matching quality spare parts</i>		

FIAT	NUOVA PANDA		
	12→	Luce diurna anteriore <i>Front lamp DRL</i>	→ 8.00.148.00
		Luce diurna anteriore <i>Front lamp DRL</i>	← 8.00.149.00

FIAT	PUNTO		
	93→99	Fanale anteriore <i>Front lamp</i>	→ 2.01.050.00
		Fanale anteriore <i>Front lamp</i>	← 2.01.051.00
	* Ricambio di qualità equivalente <i>Matching quality spare parts</i>		

FIAT	PUNTO		
	93→99	Fanale anteriore <i>Front orange lamp</i>	→ 2.01.052.00
		Fanale anteriore arancio <i>Front lamp</i>	← 2.01.053.00
	* Ricambio di qualità equivalente <i>Matching quality spare parts</i>		

FIAT		PUNTO EVO	
	09→	Fanale anteriore Front lamp	➔ 1.01.052.00
		Fanale anteriore Front lamp	➔ 1.01.053.00
	* Ricambio di qualità equivalente Matching quality spare parts		

FIAT		SEICENTO	
	98→00	Fanale anteriore Front lamp	➔ 2.01.058.00
		Fanale anteriore Front lamp	➔ 2.01.059.00
	* Ricambio di qualità equivalente Matching quality spare parts		

FIAT		SEICENTO	
	98→00	Fanale anteriore Front lamp	➔ 2.01.054.00
		Fanale anteriore Front lamp	➔ 2.01.055.00
	* Ricambio di qualità equivalente Matching quality spare parts		

FIAT		SEICENTO	
	00→	Fanale anteriore Front lamp	➔ 2.01.060.00
		Fanale anteriore Front lamp	➔ 2.01.061.00
	* Ricambio di qualità equivalente Matching quality spare parts		

FIAT		TEMPRA	
	90→96	Fanale anteriore Front lamp	➔ 2.01.126.00
		Fanale anteriore Front lamp	➔ 2.01.127.00
	* Ricambio di qualità equivalente Matching quality spare parts		

FIAT	TIPO		
	→93	Fanale anteriore <i>Front lamp</i>	→ 2.01.094.00
		Fanale anteriore <i>Front lamp</i>	← 2.01.095.00
	* Ricambio di qualità equivalente <i>Matching quality spare parts</i>		

FIAT	TIPO		
	→93	Fanale anteriore <i>Front lamp</i>	→ 2.01.096.00
		Fanale anteriore <i>Front lamp</i>	← 2.01.097.00
	* Ricambio di qualità equivalente <i>Matching quality spare parts</i>		

FIAT	TIPO RESTYLING		
	93→95	Fanale anteriore <i>Front lamp</i>	→ 2.01.098.00
		Fanale anteriore <i>Front lamp</i>	← 2.01.099.00
	* Ricambio di qualità equivalente <i>Matching quality spare parts</i>		

FIAT	UNO		
	89→	Fanale anteriore <i>Front indicator</i>	→ 2.01.084.00
		Fanale anteriore <i>Front indicator</i>	← 2.01.085.00
		Trasparente <i>Lens</i>	→ 2.01.084.24
		Trasparente <i>Lens</i>	← 2.01.085.24
	* Ricambio di qualità equivalente <i>Matching quality spare parts</i>		

FIAT		UNO		
	89→	Fanale anteriore <i>Front clear lamp</i>	→	2.01.086.00
		Fanale anteriore <i>Front lamp</i>	←	2.01.087.00
		Trasparente <i>Lens</i>	→	2.01.086.25
		Trasparente <i>Lens</i>	←	2.01.087.25
		* Ricambio di qualità equivalente Matching quality spare parts		

FIAT		UNO RESTYLING		
	89→94	Gruppo ottico <i>Front optical unit</i>	→	2.01.062.12
		Gruppo ottico <i>Front optical unit</i>	←	2.01.063.12
	* Ricambio di qualità equivalente Matching quality spare parts			

FIAT		UNO RESTYLING		
	89→94	Gruppo ottico <i>Front optical unit</i>	→	2.01.064.11
		Gruppo ottico <i>Front optical unit</i>	←	2.01.065.11
	* Ricambio di qualità equivalente Matching quality spare parts			

FORD		FIESTA MK3		
	89→95	Fanale anteriore <i>Front lamp</i>	→	2.01.070.00
		Fanale anteriore <i>Front lamp</i>	←	2.01.071.00
	* Ricambio di qualità equivalente Matching quality spare parts			

FORD		FIESTA MK3	
	89→95	Fanale anteriore <i>Front lamp</i>	➔ 2.01.072.00
		Fanale anteriore <i>Front lamp</i>	➜ 2.01.073.00
	* Ricambio di qualità equivalente <i>Matching quality spare parts</i>		

FORD		FOCUS	
	98→01	Gruppo ottico <i>Optical unit</i>	➔ 2.01.118.11
		Gruppo ottico <i>Optical unit</i>	➜ 2.01.119.11
	* Ricambio di qualità equivalente <i>Matching quality spare parts</i>		

FORD		FOCUS	
	98→01	Gruppo ottico <i>Optical unit</i>	➔ 2.01.120.12
		Gruppo ottico <i>Optical unit</i>	➜ 2.01.121.12
	* Ricambio di qualità equivalente <i>Matching quality spare parts</i>		

LANCIA		DELTA		LED	
	08→	Fanale anteriore luce diurna <i>Front lamp DRL</i>	➔ 5.01.054.00		
		Fanale anteriore luce diurna <i>Front lamp DRL</i>	➜ 5.01.055.00		

LANCIA		Y 10	
	93→96	Fanale anteriore <i>Front lamp</i>	➔ 2.01.076.00
		Fanale anteriore <i>Front lamp</i>	➜ 2.01.077.00
	* Ricambio di qualità equivalente <i>Matching quality spare parts</i>		

LANCIA		Y 10	
	96→00	Fanale anteriore Front lamp	➔ 2.01.078.00
		Fanale anteriore Front lamp	➔ 2.01.079.00
	* Ricambio di qualità equivalente Matching quality spare parts		

LANCIA		Y	
	00→03	Fanale anteriore Front lamp	➔ 2.01.056.00
		Fanale anteriore Front lamp	➔ 2.01.057.00
	* Ricambio di qualità equivalente Matching quality spare parts		

MERCEDES		200 - 500 (W124)	
	85→93	Fanale anteriore Front lamp	➔ 2.01.130.00
		Fanale anteriore Front lamp	➔ 2.01.131.00
	* Ricambio di qualità equivalente Matching quality spare parts		

MERCEDES		CLASSE C (W202)	
	93→00	Fanale anteriore Clear front lamp	➔ 2.01.132.00
		Fanale anteriore Front lamp	➔ 2.01.133.00
	* Ricambio di qualità equivalente Matching quality spare parts		

OPEL		ASTRA (F)	
	91→94	Fanale anteriore Front lamp	➔ 2.01.080.00
		Fanale anteriore Front lamp	➔ 2.01.081.00
	* Ricambio di qualità equivalente Matching quality spare parts		

PEUGEOT		106	
	91→96	Fanale anteriore <i>Front indicator</i>	➔ 2.01.112.00
		Fanale anteriore <i>Front indicator</i>	➔ 2.01.113.00
	* Ricambio di qualità equivalente Matching quality spare parts		

RENAULT		CLIO	
	90→96	Fanale anteriore <i>Front lamp</i>	➔ 2.01.114.00
		Fanale anteriore <i>Front lamp</i>	➔ 2.01.115.00
	Adatt. VALEO <i>Adaptable to VALEO</i> * Ricambio di qualità equivalente Matching quality spare parts		

VOLKSWAGEN		GOLF	
	74→89	Fanale anteriore <i>Front lamp</i>	➔ 2.01.122.00
		Trasparente <i>Lens</i>	➔ 2.01.122.24
	* Ricambio di qualità equivalente Matching quality spare parts		

VOLKSWAGEN		GOLF II SERIE	
	89→92	Gruppo ottico anteriore <i>Front optical unit</i>	➔ 2.01.134.12
		Gruppo ottico anteriore <i>Front optical unit</i>	➔ 2.01.135.12
	* Ricambio di qualità equivalente Matching quality spare parts		

VOLKSWAGEN		GOLF III SERIE	
	91→97	Gruppo ottico anteriore <i>Front optical unit</i>	➔ 2.01.136.12
		Gruppo ottico anteriore <i>Front optical unit</i>	➔ 2.01.137.12
	* Ricambio di qualità equivalente Matching quality spare parts		

VOLKSWAGEN		GOLF III SERIE	
	91→97	Copertura <i>Lens cover</i>	➔ 2.01.138.00
		Copertura <i>Lens cover</i>	➜ 2.01.139.00
	* Ricambio di qualità equivalente <i>Matching quality spare parts</i>		































VOLKSWAGEN		GOLF III SERIE	
	91→97	Copertura doppia <i>Double lens cover</i>	➔ 2.01.140.00
		Copertura doppia <i>Double lens cover</i>	➜ 2.01.141.00
	* Ricambio di qualità equivalente <i>Matching quality spare parts</i>		

VOLKSWAGEN		PASSAT (B5)	
	96→00	Gruppo ottico anteriore <i>Front optical unit</i>	➔ 2.01.142.12
		Gruppo ottico anteriore <i>Front optical unit</i>	➜ 2.01.143.12
	* Ricambio di qualità equivalente <i>Matching quality spare parts</i>		

VOLKSWAGEN		POLO S 3°	
	95→97	Fanale anteriore <i>Front lamp</i>	➔ 2.01.100.00
		Fanale anteriore <i>Front lamp</i>	➜ 2.01.101.00
	* Ricambio di qualità equivalente <i>Matching quality spare parts</i>		

VOLKSWAGEN		POLO S 3°	
	95→97	Fanale anteriore <i>Front lamp</i>	➔ 2.01.102.00
		Fanale anteriore <i>Front lamp</i>	➜ 2.01.103.00
	* Ricambio di qualità equivalente <i>Matching quality spare parts</i>		

VOLKSWAGEN	POLO 3° SERIE		
	99→02	Fanale anteriore <i>Front lamp</i>	 2.01.074.00
		Fanale anteriore <i>Front lamp</i>	 2.01.075.00
	* Ricambio di qualità equivalente Matching quality spare parts		

ALFA ROMEO	147	00→04		Fanale laterale <i>Side lamp</i>	  1.02.052.00
ALFA ROMEO	166	98→05		Fanale laterale <i>Side lamp</i>	 1.02.126.00
				Fanale laterale <i>Side lamp</i>	 1.02.127.00
ALFA ROMEO	147 restyling	00→04		Gruppo ottico laterale <i>Side optical unit</i>	 1.02.054.12
				Gruppo ottico laterale <i>Side optical unit</i>	 1.02.055.12
ALFA ROMEO	GT-GTV-MITO	04→		Gruppo ottico laterale <i>Side optical unit</i>	  1.02.060.00
ALFA ROMEO	156	97→03		Fanale laterale <i>Side lamp</i>	 1.02.056.00
				Fanale laterale <i>Side lamp</i>	 1.02.057.00
ALFA ROMEO	GIULIETTA	10→		Fanale laterale <i>Side lamp</i>	 1.02.160.00
				Fanale laterale <i>Side lamp</i>	 1.02.161.00
ALFA ROMEO	156	04→		Gruppo ottico laterale <i>Side optical unit</i>	 1.02.054.12
				Gruppo ottico laterale <i>Side optical unit</i>	 1.02.055.12
ALFA ROMEO	MITO	08→		Gruppo ottico laterale con molla in metallo <i>Side optical unit with metal spring</i>	  1.02.058.12
ALFA ROMEO	159	06→		Fanale laterale <i>Side lamp</i>	 1.02.124.00
				Fanale laterale <i>Side lamp</i>	 1.02.125.00
AUDI	A4	00→04		Gruppo ottico <i>Optical unit</i>	  2.02.172.12

* Ricambio di qualità equivalente | *Matching quality spare parts*

AUDI	A3 - A6 - A8	96→03
	Fanale laterale Side lamp	→ ← 5.02.058.00

CITROËN	STANDARD	06→
	Fanale laterale completo di lampada Side lamp bulb included	→ ← 1.02.148.00

BMW	SERIE 3 (E46)	98→01
	Gruppo ottico Optical unit	→ ← 2.02.174.12
* Ricambio di qualità equivalente Matching quality spare parts		

CITROËN	SAXO STANDARD TYPE - LED	96→03
	Gruppo ottico laterale Side optical unit	→ ← 2.02.180.12
* Ricambio di qualità equivalente Matching quality spare parts		

BMW	SERIE 5 (E39)	95→00
	Gruppo ottico Optical unit	→ ← 2.02.176.12
* Ricambio di qualità equivalente Matching quality spare parts		































FIAT	BRAVO	92→99
	Gruppo ottico Side optical unit	→ ← 1.02.070.00

BMW	SERIE 5	03→10
	Fanale laterale Side lamp	→ 5.02.068.00
	Fanale laterale Side lamp	← 5.02.069.00

FIAT	BRAVO	96→03
	Gruppo ottico con molla in metallo Side optical unit with metal spring	→ ← 1.02.058.12

CITROËN	C2-C3	02→09
	Gruppo ottico laterale Side optical unit	→ ← 2.02.178.12
* Ricambio di qualità equivalente Matching quality spare parts		

FIAT	BRAVO - BRAVA	95→01
	Fanale laterale Side lamp	→ ← 1.02.068.00

FIAT	500	65→		Fanale laterale <i>Side lamp</i>	  1.02.098.00	FIAT	GRANDE PUNTO	05→		Gruppo ottico laterale <i>Side optical unit</i>	  1.02.080.12
FIAT	CINQUECENTO - TIPO	92→		Fanale laterale <i>Side lamp</i>	  1.02.074.00	FIAT	IDEA-STILO-DOBLŌ	03→		Gruppo ottico laterale <i>Side optical unit</i>	  1.02.080.12
FIAT	NUOVA CINQUECENTO	07→		Gruppo ottico con molla in acciaio <i>Side optical unit with steel spring</i>	  1.02.146.12	FIAT	MAREA berlina sw	96→03		Fanale laterale <i>Side lamp</i>	  1.02.082.00
FIAT	COUPĒ - BARCHETTA	94→		Fanale laterale <i>Side lamp</i>	  1.02.076.00	FIAT	MULTIPLA	04→		Gruppo ottico laterale <i>Side optical unit</i>	  1.02.080.12
FIAT	CROMA	06→		Gruppo ottico laterale <i>Side optical unit</i>	  1.02.134.12	FIAT	PALIO - SIENA	97→		Fanale laterale <i>Side lamp</i>	  1.02.084.00

FIAT	PALIO - SIENA	97→
	Fanale laterale Side lamp	  1.02.086.00

FIAT	PUNTO - DOBLÒ	94→
	Gruppo ottico laterale Side optical unit	  1.02.096.12

FIAT	PANDA - 127 1ª SERIE	85→
	Fanale laterale Side lamp	  1.02.088.00

FIAT	QUBO - FIORINO	08→
	Gruppo ottico laterale Side optical unit	  1.02.080.12

FIAT	PANDA	86→03
	Fanale laterale Side lamp	  1.02.090.00

FIAT	REGATA - RITMO	89→
	Fanale laterale Side lamp	  2.02.052.00

* Ricambio di qualità equivalente | *Matching quality spare parts*

FIAT	PANDA	03→05
	Gruppo ottico laterale Side optical unit	  1.02.080.12

FIAT	SEICENTO - MULTIPLA	98→04
	Fanale laterale Side lamp	  1.02.078.00



FIAT	PUNTO	93→99
	Fanale laterale Side lamp	  1.02.092.00

FIAT	SEICENTO - MULTIPLA	98→04
	Fanale laterale Side lamp	  1.02.094.00

FIAT	UNO	89→
	Fanale laterale Side lamp	  2.02.052.00
* Ricambio di qualità equivalente <i>Matching quality spare parts</i>		

FORD	FOCUS	98→04
	Gruppo ottico laterale Side optical unit	  2.02.182.11
* Ricambio di qualità equivalente <i>Matching quality spare parts</i>		



FIAT	UNO restyling	04→
	Fanale laterale Side lamp	  1.02.066.00
* Ricambio di qualità equivalente <i>Matching quality spare parts</i>		

FORD	FOCUS	98→04
	Gruppo ottico laterale Side optical unit	  2.02.182.12
* Ricambio di qualità equivalente <i>Matching quality spare parts</i>		

FIAT	UNO restyling	89→94
	Gruppo ottico laterale Side optical unit	  1.02.066.11
* Ricambio di qualità equivalente <i>Matching quality spare parts</i>		

FORD	GALAXY	08→
	Gruppo ottico laterale su specchio retrovisore Side optical unit on rear view mirror	 5.02.054.12
	Gruppo ottico laterale su specchio retrovisore Side optical unit on rear view mirror	 5.02.055.12
* Ricambio di qualità equivalente <i>Matching quality spare parts</i>		

FORD	FIESTA	91→
	Fanale laterale Side lamp	  2.02.056.00
* Ricambio di qualità equivalente <i>Matching quality spare parts</i>		

JEEP	RENEGADE	14→
	Fanale laterale anteriore Front side lamp	 1.02.168.00
	Fanale laterale anteriore Front side lamp	 1.02.169.00
* Ricambio di qualità equivalente <i>Matching quality spare parts</i>		

FORD	FOCUS	06→
	Gruppo ottico laterale su specchio retrovisore Side optical unit on rear view mirror	 5.02.050.12
	Gruppo ottico laterale su specchio retrovisore Side optical unit on rear view mirror	 5.02.051.12
* Ricambio di qualità equivalente <i>Matching quality spare parts</i>		

LANCIA	MUSA	04→
	Gruppo ottico laterale Side optical unit	  1.02.080.12
* Ricambio di qualità equivalente <i>Matching quality spare parts</i>		

LANCIA	NUOVA DELTA	08→
	Gruppo ottico laterale <i>Side optical unit</i>	→ 1.02.054.12
	Gruppo ottico laterale <i>Side optical unit</i>	← 1.02.055.12

LANCIA	Y	00→03
	Gruppo ottico laterale <i>Side optical unit</i>	→ ← 1.02.110.12

LANCIA	Y10	→89
	Fanale laterale <i>Side lamp</i>	→ ← 1.02.066.00

LANCIA	YPSILON - LIBRA	03→07
	Gruppo ottico laterale <i>Side optical unit</i>	→ ← 1.02.144.12

LANCIA	Y10	→89
	Gruppo ottico laterale <i>Side optical unit</i>	→ ← 1.02.066.11

LANCIA	YPSILON	07→
	Gruppo ottico laterale con molla acciaio <i>Side optical unit with steel spring</i>	→ ← 1.02.146.12

LANCIA	Y10	→89
	Fanale laterale <i>Side lamp</i>	→ ← 1.02.090.00

MERCEDES	CLASSE A-B (LED)	04→08
	Fanale laterale su specchio retrovisore <i>Side lamp on rear view mirror</i>	→ 5.02.076.00
	Fanale laterale su specchio retrovisore <i>Side lamp on rear view mirror</i>	← 5.02.077.00

LANCIA	Y	96→
	Fanale laterale <i>Side lamp</i>	→ 1.02.136.00
	Fanale laterale <i>Side lamp</i>	← 1.02.137.00

MERCEDES	CLASSE A-B (LED)	08→
	Fanale laterale su specchio retrovisore <i>Side lamp on rear view mirror</i>	→ 5.02.078.00
	Fanale laterale su specchio retrovisore <i>Side lamp on rear view mirror</i>	← 5.02.079.00

MERCEDES	CLASSE C (LED)	04→07
	Fanale laterale su specchio retrovisore <i>Side lamp on rear view mirror</i>	➔ 5.02.080.00
	Fanale laterale su specchio retrovisore <i>Side lamp on rear view mirror</i>	➔ 5.02.081.00

MERCEDES	CLASSE E (LED)	99→03
	Fanale laterale su specchio retrovisore <i>Side lamp on rear view mirror</i>	➔ 5.02.088.00
	Fanale laterale su specchio retrovisore <i>Side lamp on rear view mirror</i>	➔ 5.02.089.00

MERCEDES	CLASSE C (LED)	04→07
	Fanale laterale su specchio retrovisore <i>Side lamp on rear view mirror</i>	➔ 5.02.082.00
	Fanale laterale su specchio retrovisore <i>Side lamp on rear view mirror</i>	➔ 5.02.083.00

MERCEDES	CLASSE G	84→
	Fanale laterale <i>Side lamp</i>	➔ 2.02.064.00
	Trasparente <i>Lens</i>	➔ 2.02.064.11

* Ricambio di qualità equivalente | *Matching quality spare parts*

MERCEDES	CLASSE C (LED)	07→08
	Fanale laterale su specchio retrovisore <i>Side lamp on rear view mirror</i>	➔ 5.02.084.00
	Fanale laterale su specchio retrovisore <i>Side lamp on rear view mirror</i>	➔ 5.02.085.00

MERCEDES	JEEP	84→
	Fanale laterale <i>Side lamp</i>	➔ 2.02.066.00
	Trasparente incolore <i>Lens</i>	➔ 2.02.066.12

* Ricambio di qualità equivalente | *Matching quality spare parts*

MERCEDES	CLASSE E (W210)	95→
	Gruppo ottico laterale incolore <i>Clear side Optical unit</i>	➔ 2.02.184.12
		➔

MERCEDES	JEEP	84→
	Fanale laterale arancio <i>Orange side lamp</i>	➔ 2.02.068.00
	Fanale laterale incolore <i>Clear side lamp</i>	➔ 2.02.070.00

* Ricambio di qualità equivalente | *Matching quality spare parts*

MERCEDES	CLASSE C (W202)	97→
	Gruppo ottico laterale incolore <i>Clear side Optical unit</i>	➔ 2.02.186.12
		➔

MERCEDES	SL-SLK (LED)	08→
	Fanale laterale su specchio retrovisore <i>Side lamp on rear view mirror</i>	➔ 5.02.090.00
	Fanale laterale su specchio retrovisore <i>Side lamp on rear view mirror</i>	➔ 5.02.091.00

* Ricambio di qualità equivalente | *Matching quality spare parts*

MERCEDES	SL-SLK (LED)	04→08
	Fanale laterale su specchio retrovisore Side lamp on rear view mirror	→ 5.02.092.00
	Fanale laterale su specchio retrovisore Side lamp on rear view mirror	← 5.02.093.00

OPEL	VECTRA	02→
	Fanale laterale Side lamp	→ 1.02.112.00
	Fanale laterale Side lamp	← 1.02.113.00

MINI	R56	06→
	Fanale laterale Side lamp	→ 1.02.164.00
	Fanale laterale Side lamp	← 1.02.165.00

OPEL	STANDARD	95→
	Fanale laterale Side lamp	→ ← 2.02.188.00

* Ricambio di qualità equivalente | Matching quality spare parts

MINI	R56	06→
	Fanale laterale side lamp	→ 1.02.166.00
	Fanale laterale side lamp	← 1.02.167.00

OPEL	STANDARD	93→00
	Gruppo ottico laterale Side Optical unit	→ ← 2.02.190.12

* Ricambio di qualità equivalente | Matching quality spare parts

OPEL	AGILA	00→
	Fanale laterale Side lamp	→ ← 1.02.064.00

OPEL	STANDARD	93→00
	Gruppo ottico laterale Side optical unit	→ ← 2.02.190.11

* Ricambio di qualità equivalente | Matching quality spare parts

OPEL	CORSA - MERIVA	08→
	Gruppo ottico laterale Side optical unit	→ ← 1.02.102.12

PEUGEOT	205	89→94
	Fanale laterale Side lamp	→ ← 2.02.054.00

* Ricambio di qualità equivalente | Matching quality spare parts

PEUGEOT	Z08 2008	12→
	Gruppo ottico laterale su specchietto retrovisore <i>Side optical unit on rear view mirror</i>	→ 5.02.100.12
	Gruppo ottico laterale su specchietto retrovisore <i>Side optical unit on rear view mirror</i>	← 5.02.101.12

RENAULT	MEGANE	02→
	Gruppo ottico laterale <i>Side optical unit</i>	→ 1.02.118.12
	Gruppo ottico laterale <i>Side optical unit</i>	← 1.02.119.12

PEUGEOT	STANDARD	06→
	Fanale laterale completo di lampada <i>Side lamp bulb included</i>	→ ← 1.02.148.00

RENAULT/OPEL	MASTER - MOVANO	08→
	Gruppo ottico laterale su specchio retrovisore <i>Side optical unit on rear view mirror</i>	→ 5.42.066.12
		← 5.42.067.12

RENAULT	CLIO	90→01
	Gruppo ottico laterale <i>Optical unit</i>	→ ← 2.02.192.12
		* Ricambio di qualità equivalente <i>Matching quality spare parts</i>

RENAULT/OPEL	MASTER - MOVANO	08→
	Gruppo ottico laterale su specchio retrovisore <i>Side optical unit on rear view mirror</i>	→ 5.42.068.12
		← 5.42.069.12

RENAULT	CLIO/LAGUNA	06→
	Gruppo ottico laterale incolore <i>Clear side Optical unit</i>	→ ← 1.02.116.12

SEAT	IBIZA - ALTEA	02→
	Gruppo ottico laterale <i>Side optical unit</i>	→ ← 1.02.132.12

RENAULT	KANGOO	07→13
	Gruppo ottico laterale <i>Optical unit</i>	→ ← 1.02.172.12

SKODA	FABIA	13→
	Gruppo ottico laterale su specchietto <i>Side optical unit [on mirror]</i>	→ 5.02.102.12
	Gruppo ottico laterale su specchietto <i>Side optical unit [on mirror]</i>	← 5.02.103.12

SKODA	OCTAVIA	05→
	Fanale laterale su specchio retrovisore con luce pozzanghera <i>Side lamp on rear view mirror with courtesy light</i>	 1.02.154.00
	Fanale laterale su specchio retrovisore con luce pozzanghera <i>Side lamp on rear view mirror with courtesy light</i>	 1.02.155.00

VOLKSWAGEN	GOLF	98→01
	Gruppo ottico laterale <i>Side optical unit</i>	  1.02.130.12

TOYOTA	YARIS	99→04
	Fanale laterale <i>Side lamp</i>	 1.02.158.00
	Fanale laterale <i>Side lamp</i>	 1.02.159.00

VOLKSWAGEN	GOLF/PASSAT	01→03
	Gruppo ottico laterale <i>Side optical unit</i>	  1.02.120.12

VOLKSWAGEN	CADDY	05→
	Gruppo ottico laterale <i>Side optical unit</i>	  1.02.100.12

VOLKSWAGEN	GOLF V- GOLF PLUS	03→
	Fanale laterale su specchio retrovisore <i>Side lamp on rear view mirror</i>	 1.02.122.00
	Fanale laterale su specchio retrovisore <i>Side lamp on rear view mirror</i>	 1.02.123.00



VOLKSWAGEN	GOLF	83→92
	Fanale laterale <i>Side lamp</i>	  2.02.060.00
	* Ricambio di qualità equivalente Matching quality spare parts	

VOLKSWAGEN	LUPO - FOX	05→
	Gruppo ottico laterale <i>Side optical unit</i>	  1.02.100.12

VOLKSWAGEN	GOLF	83→93
	Fanale laterale <i>Side lamp</i>	  2.02.062.00
	* Ricambio di qualità equivalente Matching quality spare parts	

VOLKSWAGEN	PASSAT - SHARAN	03→
	Fanale laterale su specchio retrovisore <i>Side lamp on rear view mirror</i>	 1.02.122.00
	Fanale laterale su specchio retrovisore <i>Side lamp on rear view mirror</i>	 1.02.123.00

VOLKSWAGEN	POLO	→08
	Fanale laterale su specchio retrovisore <i>Side lamp on rear view mirror</i>	 1.02.150.00
	Fanale laterale su specchio retrovisore <i>Side lamp on rear view mirror</i>	 1.02.151.00



VOLKSWAGEN	TOURAN (LED)	03→09
	Fanale laterale su specchio retrovisore <i>Side lamp on rear view mirror</i>	 5.02.098.00
	Fanale laterale su specchio retrovisore <i>Side lamp on rear view mirror</i>	 5.02.099.00

VOLKSWAGEN	POLO	10→
	Gruppo ottico laterale su specchietto <i>Side optical unit [on mirror]</i>	 1.02.170.12
	Gruppo ottico laterale su specchietto <i>Side optical unit [on mirror]</i>	 1.02.171.12

UNIVERSALE		
	Portalampada universale <i>Universal bulb holder</i>	1.09.050.00

VOLKSWAGEN	TIGUAN - SHARAN	05→
	Fanale laterale su specchio retrovisore <i>Side lamp on rear view mirror</i>	 1.02.156.00
	Fanale laterale su specchio retrovisore <i>Side lamp on rear view mirror</i>	 1.02.157.00

UNIVERSALE		
	Portalampada laterali <i>Side bulb holder</i>	1.09.051.00

VOLKSWAGEN	TOUAREG (LED)	02→06
	Fanale laterale su specchio retrovisore <i>Side lamp on rear view mirror</i>	 5.02.094.00
	Fanale laterale su specchio retrovisore <i>Side lamp on rear view mirror</i>	 5.02.095.00

UNIVERSALE		
	Portalampada H4 <i>Bulb holder H4</i>	3.49.076.00

VOLKSWAGEN	TOUAREG	LED
	Fanale laterale su specchio retrovisore <i>Side lamp on rear view mirror</i>	 5.02.096.00
	Fanale laterale su specchio retrovisore <i>Side lamp on rear view mirror</i>	 5.02.097.00
	10 →	

UNIVERSALE		
	Portalampada H7 <i>Bulb holder H7</i>	3.49.078.00

ALFA ROMEO	147			
	00→	Fanale posteriore esterno <i>Outer rear lamp</i>	→	1.04.050.00
		Fanale posteriore esterno <i>Outer rear lamp</i>	←	1.04.051.00

ALFA ROMEO	147			
	00→04	Fanale posteriore interno <i>Inner rear lamp</i>	→	1.04.052.00
		Fanale posteriore interno <i>Inner rear lamp</i>	←	1.04.053.00

ALFA ROMEO	147 RESTYLING			
	04→	Fanale posteriore interno <i>Inner rear lamp</i>	→	1.04.054.00
		Fanale posteriore interno <i>Inner rear lamp</i>	←	1.04.055.00

ALFA ROMEO	ALFA 159			
	05→	Fanale posteriore esterno <i>Outer rear lamp</i>	→	5.04.090.00
		Fanale posteriore esterno <i>Outer rear lamp</i>	←	5.04.091.00

ALFA ROMEO	ALFA GT			
	03→	Fanale posteriore <i>Rear lamp</i>	→	5.04.078.00
		Fanale posteriore <i>Rear lamp</i>	←	5.04.079.00

ALFA ROMEO		ALFA GT	
	03→	Fanale posteriore inferiore <i>Lower rear lamp</i>	➔ 5.04.080.00
		Fanale posteriore inferiore <i>Lower rear lamp</i>	➔ 5.04.081.00

ALFA ROMEO		ALFA GT	
	08→	Fanale retromarcia <i>Reverse lamp</i>	➔ 5.04.086.00
		Fanale retronebbia <i>Rear fog lamp</i>	➔ 5.04.087.00

ALFA ROMEO		GIULIETTA	
	09→	Fanale posteriore esterno <i>Outer rear lamp</i>	➔ 5.04.190.00
		Fanale posteriore esterno <i>Outer rear lamp</i>	➔ 5.04.191.00

ALFA ROMEO		GIULIETTA	
	10→	Fanale posteriore interno <i>Inner rear lamp</i>	➔ 5.04.192.00
		Fanale posteriore interno <i>Inner rear lamp</i>	➔ 5.04.193.00

ALFA ROMEO		GIULIETTA	
	12→	Fanale posteriore 3° STOP <i>Additional stop lamp</i>	1.04.144.00

ALFA ROMEO		MITO	
	10→	Fanale posteriore <i>Rear lamp</i>	➔ 5.04.194.00
		Fanale posteriore <i>Rear lamp</i>	➔ 5.04.195.00

ALFA ROMEO		MITO	
	10→	Cornice primerizzata <i>Primed frame</i>	➔ 5.04.194.17
		Cornice primerizzata <i>Primed frame</i>	➔ 5.04.195.17

AUDI		A7	
	15→	Fanale posteriore interno <i>Inner rear lamp</i>	➔ 1.04.202.00
		Fanale posteriore interno <i>Inner rear lamp</i>	➔ 1.04.203.00

AUDI		A7	
	15→	Fanale posteriore esterno <i>Outer rear lamp</i>	➔ 1.04.204.00
		Fanale posteriore esterno <i>Outer rear lamp</i>	➔ 1.04.205.00

AUDI		Q3	
	11→	Fanale posteriore <i>Rear lamp</i>	➔ 1.04.146.00
		Fanale posteriore <i>Rear lamp</i>	➔ 1.04.147.00

AUDI		TT	
	14→	Fanale posteriore <i>Rear lamp</i>	→ 1.04.206.00
		Fanale posteriore <i>Rear lamp</i>	← 1.04.207.00
		Paratia posteriore <i>Rear bezel</i>	→ 1.04.206.17
		Paratia posteriore <i>Rear bezel</i>	← 1.04.207.17

BMW		X1 (E84)	
	09→15	Fanale posteriore esterno <i>Outer rear lamp</i>	→ 1.04.134.00
		Fanale posteriore esterno <i>Outer rear lamp</i>	← 1.04.135.00
		Versione con guide ottiche LED <i>Version with LED lamp guides</i>	

BMW		X1 (E84)	
	09→15	Fanale posteriore esterno <i>Outer rear lamp</i>	→ 1.04.136.00
		Fanale posteriore esterno <i>Outer rear lamp</i>	← 1.04.137.00

BMW		X1 (E84)	
	09→15	Fanale posteriore interno <i>Inner rear lamp</i>	→ 1.04.138.00
		Fanale posteriore interno <i>Inner rear lamp</i>	← 1.04.139.00
		Versione con guide ottiche LED <i>Version with LED lamp guides</i>	





BMW		X1 (E84)	
	09→15	Fanale posteriore interno <i>Inner rear lamp</i>	➔ 1.04.140.00
		Fanale posteriore interno <i>Inner rear lamp</i>	➜ 1.04.141.00

CITROËN		BERLINGO	
	08→	Fanale posteriore <i>Rear lamp</i>	➔ 5.04.178.00
		Fanale posteriore <i>Rear lamp</i>	➜ 5.04.179.00
		1 porta 1 door	

CITROËN		BERLINGO	
	08→	Fanale posteriore <i>Rear lamp</i>	➔ 5.04.180.00
		Fanale posteriore <i>Rear lamp</i>	➜ 5.04.181.00
		2 porte 2 doors	

CITROËN		C4	
	01→	Fanale posteriore <i>Rear lamp</i>	➔ 2021001028
		Fanale posteriore <i>Rear lamp</i>	➜ 2021101028
		3 porte 3 doors	

CITROËN		C4	
	04→	Gruppo ottico posteriore <i>Rear optical unit</i>	➔ 2021001027
		Gruppo ottico posteriore <i>Rear optical unit</i>	➜ 2021101027
		5 porte 5 doors	

CITROËN		C4	
	04→	Gruppo ottico retromarcia <i>Reverse optical unit</i>	→ 2023101002
		Gruppo ottico retronebbia <i>Reverse fog optical unit</i>	← 2024001002
	5 porte 5 doors		
CITROËN		C4	
	04→08	Gruppo ottico retronebbia <i>Rear fog optical unit</i>	→ 2024101003
		Gruppo ottico retronebbia <i>Rear fog optical unit</i>	← 2024001003
	3 porte 3 doors		
CITROËN		C4	
	04→	Catarifrangente posteriore <i>Rear reflector</i>	→ 2025201002
		Catarifrangente posteriore <i>Rear reflector</i>	← 2025301002
	5 porte 5 doors		
CITROËN		DS3	
	09→	Fanale posteriore <i>Rear lamp</i>	→ 2021001114
		Fanale posteriore <i>Rear lamp</i>	← 2021101114
CITROËN		NEMO	
	07→	Fanale posteriore / <i>Rear lamp</i>	→ 5.04.172.00
		Fanale posteriore / <i>Rear lamp</i>	← 5.04.173.00
		Gruppo ottico posteriore / <i>Rear optical unit</i>	→ 2.04.062.10
		Gruppo ottico posteriore / <i>Rear optical unit</i>	← 2.04.063.10
		2 porte 2 doors	

DACIA		DUSTER	
	09→	Gruppo ottico posteriore <i>Rear optical unit</i>	➔ 2.04.086.10
		Gruppo ottico posteriore <i>Rear optical unit</i>	➔ 2.04.087.10
			* Ricambio di qualità equivalente Matching quality spare parts

FIAT		126	
	73→87	Fanale posteriore <i>Rear lamp</i>	➔ 2.04.078.00
		Fanale posteriore <i>Rear lamp</i>	➔ 2.04.079.00
	Trasparente posteriore <i>Rear lens</i>	➔ 2.04.078.20	
	Trasparente posteriore <i>Rear lens</i>	➔ 2.04.079.20	
			* Ricambio di qualità equivalente Matching quality spare parts

FIAT		126 BIS	
	73→87	Fanale posteriore <i>Rear lamp</i>	➔ 2.04.080.00
		Fanale posteriore <i>Rear lamp</i>	➔ 2.04.081.00
	Trasparente posteriore <i>Rear lens</i>	➔ 2.04.080.20	
	Trasparente posteriore <i>Rear lens</i>	➔ 2.04.081.20	
			* Ricambio di qualità equivalente Matching quality spare parts

FIAT		CINQUECENTO	
	92→98	Gruppo ottico posteriore <i>Rear optical unit</i>	➔ 2.04.082.10
		Gruppo ottico posteriore <i>Rear optical unit</i>	➔ 2.04.083.10
			* Ricambio di qualità equivalente Matching quality spare parts

FIAT		500	
	65→85	Fanale posteriore / <i>Rear lamp</i>	➔ 2.04.056.00
		Fanale posteriore / <i>Rear lamp</i>	➜ 2.04.057.00
		Trasparente posteriore / <i>Rear lens</i>	➔ 2.04.056.20
		Trasparente posteriore / <i>Rear lens</i>	➜ 2.04.057.20
		* Ricambio di qualità equivalente <i>Matching quality spare parts</i>	

FIAT		500-F-L-R	
	65→	FIAT 500 L	3.09.050.00
		FIAT 500 F	3.09.052.00
		FIAT 500 R	3.09.054.00
		Cablaggio completo a norme ASI <i>Complete wiring rules ASI</i>	

FIAT		BRAVO	
	95→	Gruppo ottico posteriore <i>Rear optical unit</i>	➔ 5.04.066.10
		Gruppo ottico posteriore <i>Rear optical unit</i>	➜ 5.04.067.10

FIAT		BRAVO	
	07→	Fanale posteriore <i>Rear lamp</i>	➔ 5.04.096.00
		Fanale posteriore <i>Rear lamp</i>	➜ 5.04.097.00

FIAT		BRAVO	
	07→	Fanale retromarcia <i>Reverse lamp</i>	➔ 5.04.098.00
		Fanale retronebbia <i>Rear fog lamp</i>	➜ 5.04.099.00

FIAT		DOBLŌ		
	00→	3° Stop posteriore <i>Additional stop lamp</i>		1.04.082.00

FIAT		DOBLŌ		
	00→04	Fanale posteriore / <i>Rear lamp</i>	→	5.04.052.00
		Fanale posteriore / <i>Rear lamp</i>	←	5.04.053.00
		Gruppo ottico posteriore / <i>Rear optical unit</i>	→	2.04.052.10
		Gruppo ottico posteriore / <i>Rear optical unit</i>	←	2.04.053.10
		* Ricambio di qualità equivalente Matching quality spare parts		

FIAT		DOBLŌ		
	05→09	Fanale posteriore / <i>Rear lamp</i>	→	5.04.070.00
		Fanale posteriore / <i>Rear lamp</i>	←	5.04.071.00
		Gruppo ottico posteriore / <i>Rear optical unit</i>	→	2.04.050.10
		Gruppo ottico posteriore / <i>Rear optical unit</i>	←	2.04.051.10
		* Ricambio di qualità equivalente Matching quality spare parts		

FIAT		DOBLŌ MY 09		
	09→14	Fanale posteriore <i>Rear lamp</i>	→	5.04.196.00
		Fanale posteriore <i>Rear lamp</i>	←	5.04.197.00
		Gruppo ottico posteriore <i>Rear optical unit</i>	→	2.04.076.10
		Gruppo ottico posteriore <i>Rear optical unit</i>	←	2.04.077.10
		2 porte 2 doors	* Ricambio di qualità equivalente Matching quality spare parts	

FIAT		DOBLÒ MY 09	
	09→	Fanale posteriore 3° stop <i>Additional stop lamp</i>	1.04.216.00



FIAT		DOBLÒ MY 09	
	09→14	Fanale posteriore / <i>Rear lamp</i>	→ 5.04.198.00
		Fanale posteriore / <i>Rear lamp</i>	← 5.04.199.00
		Gruppo ottico posteriore / <i>Rear optical unit</i>	→ 2.04.074.10
		Gruppo ottico posteriore / <i>Rear optical unit</i>	← 2.04.075.10
		1 porta 1 door	* Ricambio di qualità equivalente <i>Matching quality spare parts</i>



FIAT		DOBLÒ FL	
	14→	Fanale posteriore / <i>Rear lamp</i>	→ 5.04.252.00
		Fanale posteriore / <i>Rear lamp</i>	← 5.04.253.00
		Gruppo ottico posteriore / <i>Rear optical unit</i>	→ 2.04.104.10
		Gruppo ottico posteriore / <i>Rear optical unit</i>	← 2.04.105.10
		* Ricambio di qualità equivalente <i>Matching quality spare parts</i>	

FIAT		FIORINO - QUBO	
	08→	Fanale posteriore / <i>Rear lamp</i>	→ 5.04.172.00
		Fanale posteriore / <i>Rear lamp</i>	← 5.04.173.00
		Gruppo ottico posteriore / <i>Rear optical unit</i>	→ 2.04.062.10
		Gruppo ottico posteriore / <i>Rear optical unit</i>	← 2.04.063.10
		2 porte 2 doors	* Ricambio di qualità equivalente <i>Matching quality spare parts</i>

FIAT		FIORINO - QUBO	
	07→	Fanale posteriore 3° stop <i>Additional stop lamp</i>	1.04.214.00

FIAT-CITROËN-PEUGEOT		QUBO-FIORINO-NEMO-BIPPER	
	08→	Gruppo ottico posteriore <i>Rear optical unit</i>	→ 2.04.060.10
		Gruppo ottico posteriore <i>Rear optical unit</i>	← 2.04.061.10
	1 porta 1 door	* Ricambio di qualità equivalente <i>Matching quality spare parts</i>	

FIAT		IDEA	
 	04→06	Gruppo ottico posteriore <i>Rear optical unit</i>	→ 1.04.056.10
		Gruppo ottico posteriore <i>Rear optical unit</i>	← 1.04.057.10
	Portalampane <i>Lamp bulb holder</i>	→ 1.04.056.18	
	Portalampane <i>Lamp bulb holder</i>	← 1.04.057.18	

FIAT		IDEA	
 	06→	Gruppo ottico posteriore <i>Rear optical unit</i>	→ 1.04.060.10
		Gruppo ottico posteriore <i>Rear optical unit</i>	← 1.04.061.10
	Portalampane <i>Lamp bulb holder</i>	→ 1.04.060.18	
	Portalampane <i>Lamp bulb holder</i>	← 1.04.061.18	

FIAT		MULTIPLA	
	98→04	Fanale posteriore <i>Rear lamp</i>	➔ 5.04.162.00
		Fanale posteriore <i>Rear lamp</i>	➔ 5.04.163.00

FIAT		MULTIPLA	
	04→	Fanale posteriore <i>Rear lamp</i>	➔ 5.04.100.00
		Fanale posteriore <i>Rear lamp</i>	➔ 5.04.101.00

FIAT		NUOVA 500	
	07→15	Fanale posteriore <i>Rear lamp</i>	➔ 5.04.102.00
		Fanale posteriore <i>Rear lamp</i>	➔ 5.04.103.00

FIAT		NUOVA 500 FL	
	15→	Fanale posteriore <i>Rear lamp</i>	➔ 5.04.258.00
		Fanale posteriore <i>Rear lamp</i>	➔ 5.04.259.00

FIAT		NUOVA 500L	
	12→	Fanale posteriore <i>Rear lamp</i>	➔ 1.04.142.00
		Fanale posteriore <i>Rear lamp</i>	➔ 1.04.143.00

FIAT	NUOVA 500L LIVING TREKKING		
	12→15	Fanale retromarcia <i>Rear lamp</i>	➔ 5.04.112.00
		Fanale retronebbia <i>Rear fog lamp</i>	➜ 5.04.113.00

FIAT	500 L WAGON - CROSS		
	15→	Fanale retromarcia <i>Rear lamp</i>	➔ 1.04.198.00
		Fanale retronebbia <i>Rear fog lamp</i>	➜ 1.04.199.00

FIAT	500 X		
	15→	Fanale posteriore cromato <i>Chrome rear lamp</i>	➔ 1.04.186.00
		Fanale posteriore cromato <i>Chrome rear lamp</i>	➜ 1.04.187.00

FIAT	500 X		UK
	15→	<i>Chrome rear lamp</i>	➔ 1.04.190.06
		<i>Chrome rear lamp</i>	➜ 1.04.191.06
<i>Right hand drive</i>			

FIAT	500 X TREKKING		
	15→	Fanale posteriore satinato <i>Satin rear lamp</i>	➔ 1.04.188.00
		Fanale posteriore satinato <i>Satin rear lamp</i>	➜ 1.04.189.00

FIAT		500 X TREKKING		UK
	15→	Satin rear lamp	→	1.04.192.06
		Satin rear lamp	←	1.04.193.06
		Right hand drive		

FIAT		NUOVA 500		
 	15→	Fanale retromarcia Reverse lamp	→	1.04.198.00
		Fanale posteriore retronebbia Rear fog lamp	←	1.04.199.00

FIAT		NUOVA 500		UK
 	15→	Rear fog lamp	→	1.04.200.06
		Reverse lamp	←	1.04.201.06
		Right hand drive		

FIAT		NUOVA 500L LIVING		
	13→	Fanale posteriore Rear lamp	→	1.04.152.00
		Fanale posteriore Rear lamp	←	1.04.153.00

FIAT		NUOVA 500L TREKKING		
	13→	Fanale posteriore Rear lamp	→	1.04.150.00
		Fanale posteriore Rear lamp	←	1.04.151.00
		Cornice satinata <i>Satin frame</i>		

FIAT		PANDA 750	
	86→03	Fanale posteriore <i>Rear lamp</i>	→ 1.04.062.00
		Fanale posteriore <i>Rear lamp</i>	← 1.04.063.00
		Gruppo ottico posteriore <i>Rear optical unit</i>	→ 1.04.062.10
		Gruppo ottico posteriore <i>Rear optical unit</i>	← 1.04.063.10

FIAT		PANDA	
	03→12	Fanale posteriore <i>Rear lamp</i>	→ 5.04.104.00
		Fanale posteriore <i>Rear lamp</i>	← 5.04.105.00
		Gruppo ottico posteriore <i>Rear optical unit</i>	→ 2.04.072.10
		Gruppo ottico posteriore <i>Rear optical unit</i>	← 2.04.073.10
		Corpo rosso <i>Red body</i>	* Ricambio di qualità equivalente <i>Matching quality spare parts</i>

FIAT		PANDA	
	03→12	Fanale posteriore <i>Rear lamp</i>	→ 5.04.160.00
		Fanale posteriore <i>Rear lamp</i>	← 5.04.161.00
		Gruppo ottico posteriore <i>Rear optical unit</i>	→ 2.04.070.10
		Gruppo ottico posteriore <i>Rear optical unit</i>	← 2.04.071.10
		Corpo nero <i>Black body</i>	* Ricambio di qualità equivalente <i>Matching quality spare parts</i>

FIAT		NUOVA PANDA		
	17→	3° Stop posteriore <i>Additional stop lamp</i>		1.04.218.00

FIAT		NUOVA PANDA		
	12→	Fanale posteriore <i>Rear lamp</i>	→	5.04.216.00
		Fanale posteriore <i>Rear lamp</i>	←	5.04.217.00

FIAT		NUOVA PANDA		
	12→	Fanale retromarcia <i>Reverse lamp</i>	→	1.04.064.00
		Fanale retronebbia <i>Rear Fog lamp</i>	←	1.04.065.00

FIAT		PUNTO		
	99→03	Fanale posteriore <i>Rear lamp</i>	→	5.04.158.00
		Fanale posteriore <i>Rear lamp</i>	←	5.04.159.00
		5 porte 5 doors - Corpo nero <i>Black body</i>		

FIAT		PUNTO		
	03→	Fanale posteriore <i>Rear lamp</i>	→	5.04.108.00
		Fanale posteriore <i>Rear lamp</i>	←	5.04.109.00
		3 porte 3 doors		

FIAT		PUNTO		
	99→05	3° Stop posteriore <i>Additional stop lamp</i>	←	1.04.102.00

FIAT		PUNTO EVO		
 	03→	Fanale retromarcia <i>Reverse lamp</i>	→	1.04.112.00
		Fanale retronebbia <i>Rear fog lamp</i>	←	1.04.113.00
			3 porte 3 doors	

FIAT		PUNTO EVO		LED
	12→	Fanale posteriore <i>Rear lamp</i>	→	5.04.182.00
		Fanale posteriore <i>Rear lamp</i>	←	5.04.183.00
			Cornice interna rossa <i>Red frame</i>	

FIAT		PUNTO EVO		LED
	12→	Fanale posteriore <i>Rear lamp</i>	→	5.04.200.00
		Fanale posteriore <i>Rear lamp</i>	←	5.04.201.00
			Cornice interna nera <i>Black frame</i>	

FIAT		PUNTO EVO		
	→12	Cablaggio per fanale posteriore <i>Rear lamp wiring</i>	→	5.04.182.19
		Cablaggio per fanale posteriore <i>Rear lamp wiring</i>	←	5.04.183.19

FIAT	GRANDE PUNTO		
	05→	Fanale posteriore <i>Rear lamp</i>	→ 5.04.084.00
		Fanale posteriore <i>Rear lamp</i>	← 5.04.085.00

FIAT	GRANDE PUNTO		
	05→	Fanale retromarcia <i>Reverse lamp</i>	→ 5.04.086.00
		Fanale retronebbia <i>Rear fog lamp</i>	← 5.04.087.00

FIAT	SCUDO		
	95→06	Fanale posteriore <i>Rear lamp</i>	→ 5.04.152.00
			← 5.04.153.00
		Gruppo ottico posteriore <i>Rear optical unit</i>	→ 2.04.058.10
			← 2.04.059.10

FIAT	SCUDO		
	07→	Fanale posteriore <i>Rear lamp</i>	→ 5.04.154.00
			← 5.04.155.00
		Gruppo ottico posteriore <i>Rear optical unit</i>	→ 2.04.102.10
			← 2.04.103.10

FIAT	SEICENTO		
	98→	Fanale posteriore <i>Rear lamp</i>	→ 5.04.054.00
		Fanale posteriore <i>Rear lamp</i>	← 5.04.055.00

FIAT		STILO	
	01→	Fanale posteriore <i>Rear lamp</i>	➔ 5.04.068.00
		Fanale posteriore <i>Rear lamp</i>	➔ 5.04.069.00
	3 porte 3 doors		

FIAT		STILO	
	01→03	Fanale posteriore esterno <i>Outer rear lamp</i>	➔ 1.04.066.00
		Fanale posteriore esterno <i>Outer rear lamp</i>	➔ 1.04.067.00
	5 porte 5 doors		

FIAT		STILO	
	01→03	Fanale posteriore interno <i>Inner rear lamp</i>	➔ 1.04.068.00
		Fanale posteriore interno <i>Inner rear lamp</i>	➔ 1.04.069.00
	5 porte 5 doors		

FIAT		STILO	
	04→	Fanale posteriore <i>Rear lamp</i>	➔ 1.04.070.00
		Fanale posteriore <i>Rear lamp</i>	➔ 1.04.071.00
	5 porte 5 doors		

FIAT		STILO	
	04→	Gruppo ottico posteriore <i>Rear optical unit</i>	➔ 1.04.070.10
		Gruppo ottico posteriore <i>Rear optical unit</i>	➔ 1.04.071.10
	5 porte 5 doors		

FIAT		STILO SW	
	03→	Fanale posteriore esterno <i>Outer rear lamp</i>	→ 5.04.056.00
		Fanale posteriore esterno <i>Outer rear lamp</i>	← 5.04.057.00

FIAT		STILO SW	
	03→	Fanale posteriore interno <i>Inner rear lamp</i>	→ 5.04.058.00
		Fanale posteriore interno <i>Inner rear lamp</i>	← 5.04.059.00

FIAT		STILO	
	01→03	3° Stop posteriore <i>Additional stop lamp</i>	1.04.090.00
		3-5 porte <i>3-5 doors</i>	

FIAT		TIPO	
	88→95	Fanale posteriore <i>Rear lamp</i>	→ 2.04.088.00
		Fanale posteriore <i>Rear lamp</i>	← 2.04.089.00
			* Ricambio di qualità equivalente <i>Matching quality spare parts</i>

FIAT		TIPO BERLINA SEDAN	
	16→	Fanale posteriore <i>Rear lamp</i>	→ 5.04.254.00
		Fanale posteriore <i>Rear lamp</i>	← 5.04.255.00
			Esterno <i>Outer</i>

FIAT		TIPO BERLINA SEDAN	
	16→	Fanale posteriore <i>Rear lamp</i>	→ 5.04.256.00
		Fanale posteriore <i>Rear lamp</i>	← 5.04.257.00
	Interno <i>Inner</i>		

FIAT		TIPO SW	
	16→	Fanale posteriore <i>Rear lamp</i>	→ 1.04.208.00
		Fanale posteriore <i>Rear lamp</i>	← 1.04.209.00
	Esterno <i>Outer</i>		

FIAT		TIPO SW	
	16→	Fanale posteriore <i>Rear lamp</i>	→ 1.04.210.00
		Fanale posteriore <i>Rear lamp</i>	← 1.04.211.00
	Interno <i>Inner</i>		

FIAT		TIPO SW	
	16→	Fanale retronebbia <i>Fog rear lamp</i>	→ 1.04.212.00
		Fanale retronebbia <i>Rear fog lamp</i>	← 1.04.213.00



FIAT		UNO	
	→89	Fanale posteriore / <i>Rear lamp</i>	→ 2.04.068.00
		Fanale posteriore / <i>Rear lamp</i>	← 2.04.069.00
		Trasparente posteriore / <i>Rear lens</i>	→ 2.04.068.20
		Trasparente posteriore / <i>Rear lens</i>	← 2.04.069.20
	* Ricambio di qualità equivalente <i>Matching quality spare parts</i>		

FIAT		UNO RESTYLING	
	89→94	Fanale posteriore / <i>Rear lamp</i>	→ 2.04.054.00
		Fanale posteriore / <i>Rear lamp</i>	← 2.04.055.00
		Trasparente posteriore / <i>Rear lens</i>	→ 2.04.054.20
		Trasparente posteriore / <i>Rear lens</i>	← 2.04.055.20
		* Ricambio di qualità equivalente <i>Matching quality spare parts</i>	

FIAT		VARIE	
		Fanale retromarcia <i>Reverse lamp</i>	2.04.064.00
		Trasparente incolore <i>Clear lens</i>	2.04.064.22
		* Ricambio di qualità equivalente <i>Matching quality spare parts</i>	

FIAT		VARIE	
		Fanale retronebbia <i>Fog lamp</i>	2.04.066.00
		Trasparente rosso <i>Red lens</i>	2.04.066.21
		* Ricambio di qualità equivalente <i>Matching quality spare parts</i>	

FORD		FIESTA VI	
	08→	Gruppo ottico posteriore <i>Rear optical unit</i>	→ 2021001107
		Gruppo ottico posteriore <i>Rear optical unit</i>	← 2021101107
			

FORD		FOCUS II	
	04→08	Gruppo ottico posteriore <i>Rear optical unit</i>	→ 2021001023
		Gruppo ottico posteriore <i>Rear optical unit</i>	← 2021101023
		4 porte <i>4 doors</i>	
			

FORD	FOCUS II		
	04→08	Fanale posteriore <i>Rear lamp</i>	➔ 2021001025
		Fanale posteriore <i>Rear lamp</i>	➔ 2021101025

FORD	FOCUS II		
	04→11	Gruppo ottico posteriore <i>Rear optical unit</i>	➔ 2021001102
		Gruppo ottico posteriore <i>Rear optical unit</i>	➔ 2021101102
	Station wagon		

FORD	FOCUS II	LED	
	04→11	Gruppo ottico posteriore <i>Rear optical unit</i>	➔ 2021001104
		Gruppo ottico posteriore <i>Rear optical unit</i>	➔ 2021101104
	Con luce posizione a LED <i>With LED position lamp - Station wagon</i>		

FORD	FOCUS II		
	04→11	Gruppo ottico posteriore <i>Rear optical unit</i>	➔ 2021001105
		Gruppo ottico posteriore <i>Rear optical unit</i>	➔ 2021101105
	3-5 porte <i>3-5 doors</i>		

FORD	FOCUS III		
	11→	Fanale posteriore <i>Rear lamp</i>	➔ 2021001119
		Fanale posteriore <i>Rear lamp</i>	➔ 2021101119





FORD		FOCUS III	
	11→	Fanale posteriore esterno <i>Outer rear lamp</i>	➔ 2021001118
		Fanale posteriore esterno <i>Outer rear lamp</i>	➔ 2021101118

FORD		FOCUS III	
	11→	Fanale posteriore interno <i>Inner rear lamp</i>	➔ 2021001117
		Fanale posteriore interno <i>Inner rear lamp</i>	➔ 2021101117

FORD		FOCUS III TOURNIER	
	11→	Fanale posteriore esterno <i>Outer rear lamp</i>	➔ 2021001123
		Fanale posteriore esterno <i>Outer rear lamp</i>	➔ 2021101123

FORD		FOCUS III TOURNIER	
	11→	Fanale posteriore interno <i>Inner rear lamp</i>	➔ 2021001122
		Fanale posteriore interno <i>Inner rear lamp</i>	➔ 2021101122

FORD		FOCUS III TOURNIER		LED
	11→	Fanale posteriore esterno <i>Outer rear lamp</i>	➔ 2021001124	
		Fanale posteriore esterno <i>Outer rear lamp</i>	➔ 2021101124	
	Con luce posizione a LED <i>With LED position lamp</i>			

FORD		FOCUS III TOURNIER		LED
	11→	Fanale posteriore interno <i>Inner rear lamp</i>	➔	2021001121
		Fanale posteriore interno <i>Inner rear lamp</i>	➜	2021101121
	Con luce posizione a LED <i>With LED position lamp</i>			
FORD		FUSION		
	05→	Gruppo ottico posteriore <i>Rear optical unit</i>	➔	2021001031
		Gruppo ottico posteriore <i>Rear optical unit</i>	➜	2021101031
FORD		KA II MY 08		
	09→	Fanale posteriore <i>Rear lamp</i>	➔	5.04.212.00
		Fanale posteriore <i>Rear lamp</i>	➜	5.04.213.00
FORD		MONDEO		
	05→07	Gruppo ottico posteriore <i>Rear optical unit</i>	➔	2021001035
		Gruppo ottico posteriore <i>Rear optical unit</i>	➜	2021101035
	4-5 porte <i>4-5 doors</i>			
FORD		MONDEO III		
	05→07	Gruppo ottico posteriore <i>Rear optical unit</i>	➔	2021001015
		Gruppo ottico posteriore <i>Rear optical unit</i>	➜	2021101015
	4-5 porte <i>4-5 doors</i>			

FORD		MONDEO IV	
	07→	Gruppo ottico posteriore interno <i>Inner rear optical unit</i>	→ 2021001052
		Gruppo ottico posteriore interno <i>Inner rear optical unit</i>	← 2021101052
	4 porte 4 doors		

FORD		MONDEO IV	
	07→	Gruppo ottico posteriore esterno <i>Outer rear optical unit</i>	→ 2021001053
		Gruppo ottico posteriore esterno <i>Outer rear optical unit</i>	← 2021101053
	4 porte 4 doors		

FORD		MONDEO IV	
	07→	Gruppo ottico posteriore esterno <i>Outer rear optical unit</i>	→ 2021001054
		Gruppo ottico posteriore esterno <i>Outer rear optical unit</i>	← 2021101054
	5 porte 5 doors		

FORD		MONDEO IV TOURNIER	
	07→	Gruppo ottico posteriore interno <i>Inner rear optical unit</i>	→ 2021001050
		Gruppo ottico posteriore interno <i>Inner rear optical unit</i>	← 2021101050
	5 porte 5 doors		

FORD		MONDEO IV TOURNIER	
	07→	Gruppo ottico posteriore esterno <i>Outer rear optical unit</i>	→ 2021001051
		Gruppo ottico posteriore esterno <i>Outer rear optical unit</i>	← 2021101051
	5 porte 5 doors		

JEEP	RENEGADE		
	14→	Fanale posteriore <i>Rear lamp</i>	→ 5.04.250.00
		Fanale posteriore <i>Rear lamp</i>	← 5.04.251.00

JEEP	RENEGADE		
	14→	Fanale retromarcia <i>Reverse lamp</i>	→ 1.04.194.00
		Fanale retronebbia <i>Fog rear lamp</i>	← 1.04.195.00

JEEP	RENEGADE	UK	
	14→	Reverse rear lamp	→ 1.04.196.06
		Rear fog lamp	← 1.04.197.06
		Right hand drive	

LANCIA	MUSA NUOVO DOMINO		
	04→07	Gruppo ottico posteriore / <i>Rear optical unit</i>	→ 1.04.080.10
		Gruppo ottico posteriore / <i>Rear optical unit</i>	← 1.04.081.10
		Portalampane / <i>Lamp bulb holder</i>	→ 1.04.080.18
		Portalampane / <i>Lamp bulb holder</i>	← 1.04.081.18

LANCIA	MUSA	LED	
	07→	Fanale posteriore <i>Rear lamp</i>	→ 5.04.110.00
		Fanale posteriore <i>Rear lamp</i>	← 5.04.111.00

LANCIA		MUSA	
	07→	Fanale retromarcia <i>Reverse lamp</i>	 5.04.086.00
		Fanale retronebbia <i>Rear fog lamp</i>	 5.04.087.00

LANCIA		MUSA FL	
	07→	Fanale posteriore 3° Stop <i>Rear lamp 3° Stop</i>	1.04.116.00



LANCIA		NUOVA DELTA		LED	
	08→	Fanale posteriore <i>Rear lamp</i>		1.04.106.00	
		Fanale posteriore <i>Rear lamp</i>		1.04.107.00	



LANCIA		NUOVA DELTA	
	08→	Fanale retromarcia <i>Reverse lamp</i>	 1.04.108.00
		Fanale retronebbia <i>Rear fog lamp</i>	 1.04.109.00

LANCIA		NUOVA DELTA	
	08→	Fanale 3° Stop <i>Rear 3° Stop</i>	1.04.110.00

LANCIA		YPSILON MUSA		
	03→	Fanale posteriore 3° Stop <i>Rear lamp 3° Stop</i>		1.04.092.00



LANCIA		YPSILON		
	00→03	Fanale posteriore <i>Rear lamp</i>	➔	5.04.072.00
		Fanale posteriore <i>Rear lamp</i>	➜	5.04.073.00

LANCIA		YPSILON		
 	03→06	Gruppo ottico posteriore <i>Rear optical unit</i>	➔	1.04.074.10
		Gruppo ottico posteriore <i>Rear optical unit</i>	➜	1.04.075.10
		Portalampane <i>Bulb holder</i>	➔	1.04.074.18
		Portalampane <i>Bulb holder</i>	➜	1.04.075.18

LANCIA		YPSILON		
 	03→06	Gruppo ottico posteriore <i>Rear optical unit</i>	➔	1.04.078.10
		Gruppo ottico posteriore <i>Rear optical unit</i>	➜	1.04.079.10
		Portalampane <i>Bulb holder</i>	➔	1.04.078.18
		Portalampane <i>Bulb holder</i>	➜	1.04.079.18

LANCIA		YPSILON		LED
	11→	Fanale posteriore <i>Rear lamp</i>	→	5.04.214.00
		Fanale posteriore <i>Rear lamp</i>	←	5.04.215.00
	5 porte 5 doors			

LAND ROVER		FREELANDER 2		
	07→	Fanale posteriore / <i>Rear lamp</i>	→	2021001045
		Fanale posteriore / <i>Rear lamp</i>	←	2021101045
				

MASERATI		GHIBLI		
 	13→	Fanale posteriore esterno / <i>Outer rear lamp</i>	→	1.04.224.00
		Fanale posteriore esterno / <i>Outer rear lamp</i>	←	1.04.225.00
	13→	Fanale posteriore interno / <i>Inner rear lamp</i>	→	1.04.226.00
		Fanale posteriore interno / <i>Inner rear lamp</i>	←	1.04.227.00

MERCEDES		190 (W201)		
 	83→93	Gruppo ottico posteriore / <i>Rear optical unit</i>	→	2.04.090.10
		Gruppo ottico posteriore / <i>Rear optical unit</i>	←	2.04.091.10
	83→93	Trasparente posteriore / <i>Rear lens</i>	→	2.04.090.20
		Trasparente posteriore / <i>Rear lens</i>	←	2.04.091.20
	* Ricambio di qualità equivalente <i>Matching quality spare parts</i>			

MERCEDES		200 (W124)	
	85→93	Trasparente posteriore <i>Rear lens</i>	➔ 2.04.092.20
		Trasparente posteriore <i>Rear lens</i>	➜ 2.04.093.20
		Gruppo ottico posteriore <i>Rear optical unit</i>	➔ 2.04.094.10
		Gruppo ottico posteriore <i>Rear optical unit</i>	➜ 2.04.095.10
		* Ricambio di qualità equivalente Matching quality spare parts	

MERCEDES		CLASSE A - W 176	
	15→	Fanale posteriore / <i>Rear lamp</i>	➔ 1.04.220.00
		Fanale posteriore / <i>Rear lamp</i>	➜ 1.04.221.00
		Fanale posteriore / <i>Rear lamp full led</i>	➔ 1.04.222.00
		Fanale posteriore / <i>Rear lamp full led</i>	➜ 1.04.223.00

MINI		R55 CLUBMAN	
	→10	Fanale posteriore direzione arancio <i>Orange rear repeater lamp</i>	➔ 1.04.126.00
		Fanale posteriore direzione arancio <i>Orange rear repeater lamp</i>	➜ 1.04.127.00

MINI		R55		UK	
	→10	<i>Orange rear repeater lamp</i>	➔ 1.04.130.06		
		<i>Orange rear repeater lamp</i>	➜ 1.04.131.06		
		Guida a destra <i>Right hand drive</i>			

MINI		R55	
	10→	Fanale posteriore direzione incolore <i>Clear rear repeater lamp</i>	➔ 1.04.128.00
		Fanale posteriore direzione incolore <i>Clear rear repeater lamp</i>	➜ 1.04.129.00
	Versione con guide ottiche LED <i>Version with LED lamp guides</i>		

MINI		R55 RESTYLING	
	10→	Fanale posteriore direzione arancio <i>Orange rear repeater lamp</i>	➔ 1.04.166.00
		Fanale posteriore direzione arancio <i>Orange rear repeater lamp</i>	➜ 1.04.167.00
	Versione con guide ottiche LED <i>Version with LED lamp guides</i>		

MINI		R55 RESTYLING	
	10→	Fanale posteriore direzione incolore <i>Clear rear repeater lamp</i>	➔ 1.04.170.00
		Fanale posteriore direzione incolore <i>Clear rear repeater lamp</i>	➜ 1.04.171.00
	Versione con guide ottiche LED <i>Version with LED lamp guides</i>		

MINI		R55 RESTYLING		UK	
	10→	<i>Clear rear repeater lamp</i>	➔	1.04.172.06	
		<i>Clear rear repeater lamp</i>	➜	1.04.173.06	
	Versione con guide ottiche LED <i>Right hand drive</i>				

MINI		R56	
	10→	Fanale posteriore direzione arancio <i>Orange rear repeater lamp</i>	➔ 1.04.118.00
		Fanale posteriore direzione arancio <i>Orange rear repeater lamp</i>	➜ 1.04.119.00
	Versione con guide ottiche LED <i>Version with LED lamp guides</i>		

MINI	R56			
	10→	Fanale posteriore direzione incolore <i>Clear rear repeater lamp</i>	→	1.04.120.00
		Fanale posteriore direzione incolore <i>Clear rear repeater lamp</i>	←	1.04.121.00
	Guida a destra <i>Right hand drive</i>			

MINI	R56			
	06→12	Cornice <i>Frame</i>	→	1.04.118.17
		Cornice <i>Frame</i>	←	1.04.119.17

MINI	R56 COOPER R56N R57			
	08→	Fanale retromarcia e retronebbia <i>Rear fog lamp</i>	→	1.04.124.00
		Fanale retromarcia e retronebbia <i>Rear fog lamp</i>	←	1.04.125.00

MINI	R56 COOPER ONE DIESEL			
	07→	Fanale retronebbia centrale <i>Rear central fog lamp</i>		1.04.122.00

MINI	R56N COOPER			
	10→	Fanale posteriore direzione arancio <i>Orange rear repeater lamp</i>	→	1.04.174.00
		Fanale posteriore direzione arancio <i>Orange rear repeater lamp</i>	←	1.04.175.00
	Versione con guide ottiche LED <i>Version with LED lamp guides</i>			

MINI		R56N COOPER	
	10→	Fanale posteriore direzione incolore <i>Clear rear repeater lamp</i>	➔ 1.04.176.00
		Fanale posteriore direzione incolore <i>Clear rear repeater lamp</i>	➔ 1.04.177.00
	Versione con guide ottiche LED <i>Version with LED lamp guides</i>		

MINI		R56N COOPER D	
	08→	Fanale retronebbia e retromarcia <i>Rear fog lamp</i>	1.04.178.00

MINI		R56N R57 COOPER	
	08→	Fanale retronebbia <i>Reverse lamp</i>	1.04.122.00

MINI		R60 COUNTRYMAN	
	10→	Fanale posteriore <i>Rear lamp</i>	➔ 1.04.180.00
		Fanale posteriore <i>Rear lamp</i>	➔ 1.04.181.00

MINI		R60 COUNTRYMAN		UK
	10→	<i>Rear lamp</i>	➔	1.04.182.06
		<i>Rear lamp</i>	➔	1.04.183.06
	<i>Right hand drive</i>			

MINI		R60 COUNTRYMAN	
	10→	Cornice cromata <i>Chrome-plated frame</i>	➔ 1.04.180.17
		Cornice cromata <i>Chrome-plated frame</i>	➜ 1.04.181.17

NISSAN RENAULT		PRIMESTAR TRAFFIC	
	05→	Fanale posteriore <i>Rear lamp</i>	➔ 5.04.120.00
		Fanale posteriore <i>Rear lamp</i>	➜ 5.04.121.00

OPEL		ASTRA H	
	04→	Fanale posteriore <i>Rear lamp</i>	➔ 2021001049
		Fanale posteriore <i>Rear lamp</i>	➜ 2021101049

OPEL		CORSA	
	06→	Fanale posteriore <i>Rear lamp</i>	➔ 5.04.122.00
		Fanale posteriore <i>Rear lamp</i>	➜ 5.04.123.00
			3 porte 3 doors

OPEL		CORSA 3 PORTE	
	83→00	Gruppo ottico posteriore <i>Rear optical unit</i>	➔ 2.04.096.10
		Gruppo ottico posteriore <i>Rear optical unit</i>	➜ 2.04.097.10
			* Ricambio di qualità equivalente Matching quality spare parts

PEUGEOT		207	
	06→	Fanale posteriore <i>Rear lamp</i>	➔ 2021001036
		Fanale posteriore <i>Rear lamp</i>	➔ 2021101036

PEUGEOT		207 CC	
	07→	Fanale posteriore <i>Rear lamp</i>	➔ 2021001037
		Fanale posteriore <i>Rear lamp</i>	➔ 2021101037

PEUGEOT		207	
	07→	Fanale posteriore <i>Rear lamp</i>	➔ 2021001038
		Fanale posteriore <i>Rear lamp</i>	➔ 2021101038
	Station wagon		

PEUGEOT		PARTNER	
	08→	Fanale posteriore <i>Rear lamp</i>	➔ 5.04.178.00
		Fanale posteriore <i>Rear lamp</i>	➔ 5.04.179.00
	1 porta 1 door		

PEUGEOT		PARTNER	
	08→	Fanale posteriore <i>Rear lamp</i>	➔ 5.04.180.00
		Fanale posteriore <i>Rear lamp</i>	➔ 5.04.181.00
	2 porte 2 doors		

RENAULT		MEGANE III LAGUNA	
	08→	Fanale posteriore <i>Rear lamp</i>	➔ 1.04.184.00
		Fanale posteriore <i>Rear lamp</i>	➔ 1.04.185.00

RENAULT		SCENIC	
	12→	Fanale retronebbia <i>Rear fog lamp</i>	➔ 1.04.148.00
		Fanale posteriore retromarcia <i>Reverse rear lamp</i>	➔ 1.04.149.00

SEAT		ALTEA XL	
	06→	Fanale posteriore interno <i>Inner rear lamp</i>	➔ 2021001056
		Fanale posteriore interno <i>Inner rear lamp</i>	➔ 2021101056

SEAT		ALTEA XL	
	06→	Fanale posteriore esterno <i>Outer rear lamp</i>	➔ 2021001046
		Fanale posteriore esterno <i>Outer rear lamp</i>	➔ 2021101046

SKODA		FABIA III	
	04→	Gruppo ottico posteriore <i>Rear optical unit</i>	➔ 2021001047
		Gruppo ottico posteriore <i>Rear optical unit</i>	➔ 2021101047
			Berlina Sedan

SKODA		OCTAVIA 2	
	04→	Gruppo ottico posteriore <i>Rear optical unit</i>	→ 2021001019
		Gruppo ottico posteriore <i>Rear optical unit</i>	← 2021101019

SKODA		ROOMSTER	
	06→	Fanale posteriore <i>Rear lamp</i>	→ 2021001042
		Fanale posteriore <i>Rear lamp</i>	← 2021101042

SKODA		SUPERB II	
	13→	Fanale posteriore esterno <i>Outer rear lamp</i>	→ 1.04.154.00
		Fanale posteriore esterno <i>Outer rear lamp</i>	← 1.04.155.00



SKODA		SUPERB II	
	13→	Fanale posteriore interno <i>Inner rear lamp</i>	→ 1.04.156.00
		Fanale posteriore interno <i>Inner rear lamp</i>	← 1.04.157.00

SKODA		SUPERB II		UK
	13→	<i>Inner rear lamp</i>	→	1.04.158.00
		<i>Inner rear lamp</i>	←	1.04.159.00
			<i>Right hand drive</i>	

SKODA	SUPERB II		
	13→	Fanale posteriore SW <i>Rear lamp SW</i>	➔ 1.04.160.00
		Fanale posteriore SW <i>Rear lamp SW</i>	➜ 1.04.161.00

SKODA	SUPERB II	UK
	Rear lamp SW	➔ 1.04.162.00
	Rear lamp SW	➜ 1.04.163.00
	Right hand drive	

TOYOTA	AYGO FL		
	09→	Gruppo ottico posteriore <i>Rear optical unit</i>	➔ 5.04.208.10
		Gruppo ottico posteriore <i>Rear optical unit</i>	➜ 5.04.209.10

VOLKSWAGEN	CADDY LIFE		
	04→	Fanale posteriore <i>Rear lamp</i>	➔ 2021001021
		Fanale posteriore <i>Rear lamp</i>	➜ 2021101021
	2 porte 2 doors		

VOLKSWAGEN	GOLF I SERIE		
	83→91	Gruppo ottico posteriore <i>Rear optical unit</i>	➔ 2.04.098.10
		Gruppo ottico posteriore <i>Rear optical unit</i>	➜ 2.04.099.10
	* Ricambio di qualità equivalente <i>Matching quality spare parts</i>		

VOLKSWAGEN		GOLF V	
	04→	Fanale posteriore esterno <i>Outer rear lamp</i>	→ 5.04.062.00
		Fanale posteriore esterno <i>Outer rear lamp</i>	← 5.04.063.00











VOLKSWAGEN		GOLF V	
	04→	Fanale posteriore interno <i>Inner rear lamp</i>	→ 5.04.064.00
		Fanale posteriore interno <i>Inner rear lamp</i>	← 5.04.065.00

VOLKSWAGEN		GOLF PLUS	
	05→	Fanale posteriore esterno <i>Outer rear lamp</i>	→ 5.04.134.00
		Fanale posteriore esterno <i>Outer rear lamp</i>	← 5.04.135.00

VOLKSWAGEN		POLO IV MY 05	
	05→	Fanale posteriore <i>Rear lamp</i>	→ 5.04.150.00
		Fanale posteriore <i>Rear lamp</i>	← 5.04.151.00

VOLKSWAGEN		POLO V	
	09→	Fanale posteriore <i>Rear lamp</i>	→ 5.04.210.00
		Fanale posteriore <i>Rear lamp</i>	← 5.04.211.00

VOLKSWAGEN	SHARAN TIGUAN		
	09→	Fanale posteriore retromarcia <i>Reverse rear lamp</i>	 1.04.114.00
		Fanale posteriore retromarcia <i>Reverse rear lamp</i>	 1.04.115.00

ALFA ROMEO	145 146 GTV	94→		Fanale targa Number plate light	1.05.050.00	ALFA ROMEO	STELVIO	80→82		Fanale targa Number plate light	1.05.080.80
										LED	
ALFA ROMEO	147	00→04		Fanale targa Number plate light	1.05.052.00	AUTOBIANCHI	A 112	80→82		Fanale targa Number plate light	1.05.056.00
ALFA ROMEO	156	97→03		Fanale targa Number plate light	1.05.054.00	BMW	S5 X5	03→10		Fanale targa Number plate light	5.05.050.00
ALFA ROMEO	159	06→		Fanale targa Number plate light	1.05.104.00	BMW				Fanale targa Number plate light	1.05.112.00
ALFA ROMEO	GIULIA	06→		Fanale targa Number plate light	1.05.072.80	FIAT	500	65→		Fanale targa Number plate light	5.06.050.00
										LED	

FIAT	NUOVA 500L	12→
	Fanale targa Number plate light	1.05.092.00

FIAT	CROMA	06→
	Fanale targa Number plate light	1.05.106.00

FIAT	127 3° SERIE	82→83
	Fanale targa Number plate light	1.05.056.00

FIAT	DOBLÒ MY 2009	09→
	Fanale targa Number plate light	1.05.120.00

FIAT	BRAVO BRAVA	95→01
	Fanale targa Number plate light	1.05.062.00

FIAT	DOBLÒ	00→
	Fanale targa Number plate light	1.05.074.00

FIAT	CINQUECENTO	→98
	Fanale targa Number plate light	1.05.064.00

FIAT	FIORINO	91→
	Fanale targa Number plate light	2.05.050.00
* Ricambio di qualità equivalente <i>Matching quality spare parts</i>		

FIAT	CROMA	→90
	Fanale targa Number plate light	1.05.068.00

FIAT	FIORINO - QUBO	07→
	Fanale targa Number plate light	1.05.118.00

FIAT	MAREA SW MULTIPLA	98→04
	Fanale targa <i>Number plate light</i>	1.05.054.00

FIAT	TEMPRA TIPO	90→96
	Fanale targa <i>Number plate light</i>	1.05.070.00

FIAT	PANDA	→03
	Fanale targa <i>Number plate light</i>	1.05.056.00

FORD	FOCUS C-MAX	05→07
	Vetrino luce targa <i>Number plate light small glass</i>	5.05.052.00

FIAT	PUNTO	99→
	Fanale targa <i>Number plate light</i>	1.05.084.00

FORD	FIESTA MK 4	95→
	Fanale targa <i>Number plate light</i>	2.05.052.00
* Ricambio di qualità equivalente <i>Matching quality spare parts</i>		

FIAT	SEICENTO	98→
	Fanale targa <i>Number plate light</i>	1.05.096.00

JEEP	RENEGADE	98→
	Fanale targa <i>Number plate light</i>	1.05.114.00

FIAT	STILO SW	01→
	Fanale targa <i>Number plate light</i>	1.05.102.12

LANCIA	DEDRA	89→
	Fanale targa <i>Number plate light</i>	1.05.070.00

LANCIA	K	94→
	Fanale targa Number plate light	1.05.086.00

MINI		01-06
	Fanale targa Number plate light	1.05.116.12
	Cablaggio con portalampane Wiring with bulbholder	1.05.116.19

LANCIA	Y10	→92
	Fanale targa Number plate light	1.05.060.00

OPEL	ASTRA 3/5 PORTE	→06
	Fanale targa Number plate light	1.05.100.00

LANCIA	Y10	93→96
	Fanale targa Number plate light	1.05.058.00

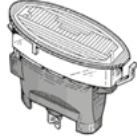
OPEL	CORSA B 3-5 PORTE	93→00
	Fanale targa Number plate light	2.05.054.00

LANCIA	YPSILON	03→
	Vetrino luce targa Number plate light small glass	1.05.090.12

OPEL	CORSA VECTRA	→06
	Fanale targa Number plate light	1.05.100.00

LANCIA	YPSILON	03→
	Portalampane luce targa Number plate light bulb-holder	1.05.092.18

OPEL	CORSA MERIVA TIGRA	→06
	Vetrino luce targa Number plate light small glass	1.05.098.00

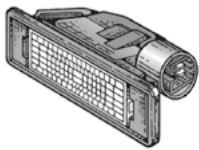
PEUGEOT	106 - 306 - 406 - 605 - 806	91→
	Fanale targa Number plate light	2.05.056.00
* Ricambio di qualità equivalente Matching quality spare parts		

VOLVO	S40 V5 C30 S60 S80	00→
	Fanale targa Number plate light	5.05.060.00

PEUGEOT/ CITRÖEN	PARTNER - BERLINGO	09→
	Fanale targa Number plate light	1.05.126.00

PEUGEOT/ CITRÖEN	PARTNER - BERLINGO	09→
	Fanale targa Number plate light	1.05.124.00



RENAULT	CLIO SCENIC MODUS	
	Fanale targa Number plate light	1.05.110.00



RENAULT	KANGOO	07→13
	Fanale targa Number plate light	1.05.122.00

ALFA ROMEO	145	98→
	Catadiottro Reflector	 1.06.076.00
	Catadiottro Reflector	 1.06.077.00

ALFA ROMEO	159	06→
	Catadiottro Reflector	 1.06.078.00
	Catadiottro Reflector	 1.06.079.00



ALFA ROMEO	147	00→04
	Catadiottro Reflector	 1.06.052.00
	Catadiottro Reflector	 1.06.053.00

CITROËN		02→
	Catadiottro Reflector	 1.06.086.00
	Catadiottro Reflector	 1.06.087.00



ALFA ROMEO	147 GTA	04→05
	Catadiottro Reflector	 1.06.054.00
	Catadiottro Reflector	 1.06.055.00

FIAT	BRAVO MULTIPLA	95→01
	Catadiottro Reflector	 1.06.058.00
	Catadiottro Reflector	 1.06.059.00

ALFA ROMEO	GIULIETTA	10→
	Catadiottro Reflector	 1.06.084.00
	Catadiottro Reflector	 1.06.085.00

FIAT	CROMA	06→
	Catadiottro Reflector	 1.06.074.00
	Catadiottro Reflector	 1.06.075.00

ALFA ROMEO	156	97→
	Catadiottro Reflector	 1.06.080.00
	Catadiottro Reflector	 1.06.081.00

FIAT	500 X	15→
	Catadiottro posteriore Rear reflector	 1.06.088.00
	Catadiottro posteriore Rear reflector	 1.06.089.00

FIAT	DOBLÒ 2009	09→
	Catadiottro posteriore Rear reflector	 1.06.092.00
	Catadiottro posteriore Rear reflector	 1.06.093.00

LANCIA	YPSILON	06→
	Catadiottro Reflector	 1.06.070.00

FIAT	MAREA SW	96→03
	Catadiottro Reflector	 1.06.064.00
	Catadiottro Reflector	 1.06.065.00

LANCIA	YPSILON	06→
	Catadiottro Reflector	 1.06.070.01



FIAT	PUNTO 315 PORTE	03→
	Catadiottro Reflector	 1.06.066.00
	Catadiottro Reflector	 1.06.067.00

LANCIA	YPSILON	06→
	Catadiottro Reflector	 1.06.071.00



FIAT	PUNTO SPORT	03→
	Catadiottro Reflector	 1.06.068.00
	Catadiottro Reflector	 1.06.069.00



MERCEDES	VITO	03→
	Catadiottro Reflector	 5.06.068.00
	Catadiottro Reflector	 5.06.069.00

JEEP	RENEGADE	03→
	Catadiottro posteriore Rear reflector	 1.06.090.00
	Catadiottro posteriore Rear reflector	 1.06.091.00
Versione americana - USA version		

PEUGEOT	147	02→
	Catadiottro Reflector	 1.06.086.00
	Catadiottro Reflector	 1.06.087.00

SEAT	IBIZA LEON CORDOBA	02→08
	Catadiotro Reflector	 5.06.070.00
	Catadiotro Reflector	 5.06.071.00

SEAT	IBIZA	02→08
	Catadiotro Reflector	 5.06.072.00
	Catadiotro Reflector	 5.06.073.00

SEAT	IBIZA	02→08
	Catadiotro Reflector	 5.06.074.00
	Catadiotro Reflector	 5.06.075.00

VOLKSWAGEN	TOUAREG	02→07
	Catadiotro Reflector	 5.06.080.00
	Catadiotro Reflector	 5.06.081.00

FIAT	BRAVO	07→
	Plafoniera <i>Dome lamp</i>	1.08.058.00

FIAT IVECO	DOBLÒ DUCATO DAILY	03→
	Plafoniera con torcia estraibile <i>Dome lamp with removable flashlight</i>	1.08.070.00

FIAT	DOBLÒ	07→
	Plafoniera <i>Dome lamp</i>	1.08.068.00

FIAT	PANDA	03→
	Plafoniera <i>Dome lamp</i>	1.08.056.00
	Grigio 670 <i>Grey 670</i>	

FIAT	PUNTO	97→
	Plafoniera <i>Dome lamp</i>	1.08.052.00
	Grigio 669 <i>Grey 669</i>	

ALFA ROMEO		147	
	00→04	Proiettore (H7+H1) Headlamp (H7+H1)	➔ 8.00.092.00
		Proiettore (H7+H1) Headlamp (H7+H1)	➔ 8.00.093.00
	Con motorino With small device		

ALFA ROMEO		MITO	
	04→	Proiettore (H7+H7) Headlamp (H7+H7)	➔ 8.00.056.00
		Proiettore (H7+H7) Headlamp (H7+H7)	➔ 8.00.057.00
	Con motorino With small device		

CITROËN		DS3	
	09→	Proiettore (H7+H1) Headlamp (H7+H1)	➔ 2020001105
		Proiettore (H7+H1) Headlamp (H7+H1)	➔ 2020101105
	Parabola cromata con luce di curva dinamica Chrome plated reflex-reflector with dynamic turn light		

CITROËN		DS3	
	09→	Proiettore (H7+H1) Headlamp (H7+H1)	➔ 2020001107
		Proiettore (H7+H1) Headlamp (H7+H1)	➔ 2020101107
	Con motorino With small device Parabola nera Black plated Reflex reflector		

FIAT		500	
	65→	Proiettore ASY con cornice ASY Headlamp with frame	➔ 8.90.050.00
		Proiettore ASY senza cornice ASY Headlamp without frame	➔ 8.90.052.00
	Cornice cromata Chromed plated frame		➔ 8.90.050.17

FIAT		NUOVA 500	
	07→	Proiettore anabbagliante (H7) <i>Low-beam headlamp (H7)</i>	➔ 8.00.076.00
		Proiettore anabbagliante (H7) <i>Low-beam headlamp (H7)</i>	➔ 8.00.077.00
	Con motorino <i>With small device</i>		

FIAT		NUOVA 500	
	07→	Proiettore abbagliante luce posizione (H1) <i>High-beam position lamp headlamp (H1)</i>	➔ 8.00.078.00
		Proiettore abbagliante luce posizione (H1) <i>High-beam position lamp headlamp (H1)</i>	➔ 8.00.079.00

FIAT		NUOVA 500	
	15→	Proiettore Fendinebbia (H1) <i>Fog lamp (H1)</i>	➔ 8.20.102.00
		Proiettore Fendinebbia (H1) <i>Fog lamp (H1)</i>	➔ 8.20.103.00

FIAT CITROËN PEUGEOT		FIORINO NEMO BIPPER QUBO	
	08→	Proiettore (H4) <i>Headlamp (H4)</i>	➔ 8.00.054.00
		Proiettore (H4) <i>Headlamp (H4)</i>	➔ 8.00.055.00
	Con motorino <i>With small device</i>		

FIAT		PANDA	
	03→	Proiettore (H4) <i>Headlamp (H4)</i>	➔ 8.00.080.00
		Proiettore (H4) <i>Headlamp (H4)</i>	➔ 8.00.081.00

FIAT	PANDA			
	09→	Proiettore (H4) 8 PIN Headlamp (H4) 8 PIN	➔	8.00.090.00
		Proiettore (H4) 8 PIN Headlamp (H4) 8 PIN	➔	8.00.091.00

FIAT	NUOVA PANDA			
	12→	Proiettore (H4) Headlamp (H4)	➔	8.00.146.00
		Proiettore (H4) Headlamp (H4)	➔	8.00.147.00

FIAT	PUNTO			
	03→06	Proiettore (H7+H1) Headlamp (H7+H1)	➔	8.00.060.00
		Proiettore (H7+H1) Headlamp (H7+H1)	➔	8.00.061.00
		Con motorino With small device Con oscuratore With obscurator		

FIAT	GRANDE PUNTO			
	05→08	Proiettore (H4) Headlamp (H4)	➔	8.00.064.00
		Proiettore (H4) Headlamp (H4)	➔	8.00.065.00
		Con motorino With small device		

FIAT	GRANDE PUNTO			
 	08→	Proiettore (H4) Headlamp (H4)	➔	8.00.066.00
		Proiettore (H4) Headlamp (H4)	➔	8.00.067.00
		Con motorino With small device		









FIAT		PUNTO EVO	
	12→	Proiettore (H4) Headlamp (H4)	➔ 8.00.142.00
		Proiettore (H4) Headlamp (H4)	➔ 8.00.143.00
	Con motorino With small device Parabola scura Dark reflex-reflector		







FIAT		PUNTO EVO	
	09→	Proiettore (H4) Headlamp (H4)	➔ 8.00.068.00
		Proiettore (H4) Headlamp (H4)	➔ 8.00.069.00
	Con motorino With small device Con luce diurna Day running light		





FIAT		SCUDO	
	07→	Proiettore (H4) Headlamp (H4)	➔ 8.00.070.00
		Proiettore (H4) Headlamp (H4)	➔ 8.00.071.00
	Con motorino With small device		

FORD		MONDEO IV	
	07→	Proiettore (H7+H1) Headlamp (H7+H1)	➔ 2020001069
		Proiettore (H7+H1) Headlamp (H7+H1)	➔ 20201011069
	Con motorino With small device		

FORD		MONDEO IV		XENON	
	07→	Proiettore (D1S+H1) Headlamp (D1S+H1)	➔ 2020001067		
		Proiettore (D1S+H1) Headlamp (D1S+H1)	➔ 2020101067		
	Con luce di curva dinamica With dynamic turn light Con motorino With small device 4 5 porte 4 5 doors				

LANCIA		YPSILON			
	11→	Proiettore (H4) Headlamp (H4)	➔ 8.00.134.00		
		Proiettore (H4) Headlamp (H4)	➔ 8.00.135.00		
	HLG - 5 porte 5 doors				
OPEL		MERIVA			
	10→	Proiettore (H7+H1) Headlamp (H7+H1)	➔ 2020001108		
		Proiettore (H7+H1) Headlamp (H7+H1)	➔ 2020101108		
	Con motorino With small device Con luce guida diurna Front day light				
SKODA		OCTAVIA 2		CLASSIC	
	04→	Proiettore (H1+H7) Headlamp (H1+H7)	➔ 2020001040		
		Proiettore (H1+H7) Headlamp (H1+H7)	➔ 2020101040		
	Con motorino With small device Completo di lampade Bulb included				
TOYOTA		YARIS			
	06→09	Proiettore (H4) Headlamp (H4)	➔ 8.00.072.00		
		Proiettore (H4) Headlamp (H4)	➔ 8.00.073.00		
	Con motorino With small device				
VOLKSWAGEN		CADDY III			
	04→	Proiettore (H1+H7) Headlamp (H1+H7)	➔ 2020001045		
		Proiettore (H1+H7) Headlamp (H1+H7)	➔ 2020101045		
	Con motorino With small device Completo di lampade Bulb included				

ALFA ROMEO		159		
	06→	Fendinebbia (H1) <i>Fog lamp (H1)</i>	↔	8.20.050.00
		Staffa nera <i>Black bracket</i>		
ALFA ROMEO		GIULIETTA		
	10→	Fendinebbia (H1) <i>Fog lamp (H1)</i>	↔	8.20.074.00
AUDI		A6		
	04→	Fendinebbia (H7) <i>Fog lamp (H7)</i>	→	2020201005
		Fendinebbia (H7) <i>Fog lamp (H7)</i>	←	2020301005
				
FIAT		500		
	06→	Fendinebbia (H1) <i>Fog lamp (H1)</i>	→	8.20.056.00
		Fendinebbia (H1) <i>Fog lamp (H1)</i>	←	8.20.057.00
FIAT		500 ABARTH		
	09→	Proiettore Fendinebbia (H1) <i>Fog lamp (H1)</i>	→	8.20.098.00
		Proiettore Fendinebbia (H1) <i>Fog lamp (H1)</i>	←	8.20.099.00

FIAT		NUOVA 500L PANDA		
	12→	Proiettore Fendinebbia (H1) <i>Fog lamp (H1)</i>	↔	8.20.094.00
FIAT		CROMA DUCATO PANDA		
	06→	Fendinebbia (H1) <i>Fog lamp (H1)</i>	↔	8.20.070.00
FIAT		PANDA CROSS		
	13→	Fendinebbia (H1) <i>Fog lamp (H1)</i>	↔	8.20.068.00
FIAT		PUNTO EVO		
	08→	Fendinebbia (H11) <i>Fog lamp (H11)</i>	↔	8.20.082.00
FORD		KA		
	08→	Fendinebbia (H1) <i>Fog lamp (H1)</i>	→	8.20.072.00
		Fendinebbia (H1) <i>Fog lamp (H1)</i>	←	8.20.073.00

LANCIA		YPSILON		
	12→	Fendinebbia (H1) <i>Fog lamp (H1)</i>	→	8.20.096.00
		Fendinebbia (H1) <i>Fog lamp (H1)</i>	←	8.20.097.00

RENAULT CITROËN DACIA FORD PEUGEOT				
	12→	Fendinebbia (H11) <i>Fog lamp (H11)</i>	→ ←	8.50.070.00
		Completo di lampade <i>Bulb included</i>		

lamps for industrial vehicles

FANALI PER VEICOLI INDUSTRIALI

DAF		XF - CF - LF	
	08→	Gruppo ottico <i>Optical unit</i>	→ ← 2.41.114.12
		* Ricambio di qualità equivalente <i>Matching quality spare parts</i>	
DAF		XF	
	08→	Gruppo ottico anteriore su pedana <i>Side optical unit on steps</i>	→ ← 2.41.116.20
		Portalampade <i>Light bulb holder</i>	1.09.052.00
		* Ricambio di qualità equivalente <i>Matching quality spare parts</i>	
FIAT		619 - 684 - 697	
		Trasparente anteriore <i>Front lens</i>	→ 2.41.110.27
		Trasparente anteriore <i>Front lens</i>	← 2.41.111.27
		* Ricambio di qualità equivalente <i>Matching quality spare parts</i>	
FIAT OM		110 130 170	
		Fanale anteriore <i>Front lamp</i>	→ ← 2.41.102.00 2.41.103.00
		Trasparente <i>Lens</i>	→ ← 2.41.102.27 2.41.103.27
		* Ricambio di qualità equivalente <i>Matching quality spare parts</i>	
FIAT OM		50 55 65 75 80	
	75→	Trasparente <i>Lens</i>	→ 2.41.104.27
		Trasparente <i>Lens</i>	← 2.41.105.27
		* Ricambio di qualità equivalente <i>Matching quality spare parts</i>	

FIAT		DUCATO	
	88→94	Fanale anteriore <i>Front indicator</i>	➔ 5.41.056.00
		Fanale anteriore <i>Front indicator</i>	➔ 5.41.057.00

FIAT		DUCATO	
	94→02	Gruppo ottico anteriore <i>Front optical unit</i>	➔ 2.41.108.12
		Gruppo ottico anteriore <i>Front optical unit</i>	➔ 2.41.109.12
			* Ricambio di qualità equivalente Matching quality spare parts

FIAT / CITROËN		SCUDO	
	95→04	Fanale anteriore <i>Front indicator</i>	➔ 5.41.068.00
		Fanale anteriore <i>Front indicator</i>	➔ 5.41.069.00

ISUZU		NPR	
	08→	Fanale anteriore <i>Front indicator</i>	➔ 2.41.090.00
		Fanale anteriore <i>Front indicator</i>	➔ 2.41.091.00
			* Ricambio di qualità equivalente Matching quality spare parts

IVECO		DAILY	
	90→00	Fanale anteriore / <i>Front lamp</i>	➔ 2.41.048.00
			➔ 2.41.049.00
	90→00	Trasparente anteriore <i>Front lens</i>	➔ 2.41.048.25
			➔ 2.41.049.25
		* Ricambio di qualità equivalente Matching quality spare parts	

IVECO		DAILY (S2000)	
	99→04	Fanale anteriore / <i>Front indicator</i>	→ 5.41.072.00
		Fanale anteriore / <i>Front indicator</i>	← 5.41.073.00
	02→07	Fanale anteriore / <i>Front indicator</i>	→ 5.41.070.00
		Fanale anteriore / <i>Front indicator</i>	← 5.41.071.00

IVECO		DAILY 2014	
	14→	Fanale anteriore incolore <i>Clear front indicator</i>	→ 5.41.086.00
		Fanale anteriore incolore <i>Clear front indicator</i>	← 5.41.087.00

IVECO		EUROCARGO	
	91→	Fanale anteriore incolore <i>Clear front lamp</i>	→ 2.41.120.00
		Fanale anteriore incolore <i>Clear front lamp</i>	← 2.41.121.00
	* Ricambio di qualità equivalente <i>Matching quality spare parts</i>		

IVECO		EUROCARGO	
	91→02	Fanale anteriore <i>Front indicator</i>	→ 2.41.100.00
		Fanale anteriore <i>Front indicator</i>	← 2.41.101.00
	* Ricambio di qualità equivalente <i>Matching quality spare parts</i>		

IVECO		EUROCARGO	
	04→	Fanale anteriore <i>Front indicator</i>	→ ← 2.41.054.00
		* Ricambio di qualità equivalente <i>Matching quality spare parts</i>	

IVECO		EUROTECH EUROTRAKKER	
	93→02	Fanale anteriore <i>Front indicator</i>	➔ 5.41.054.00
		Fanale anteriore <i>Front indicator</i>	➔ 5.41.055.00

IVECO		EUROSTAR EUROTECH	
	91→02	Fanale anteriore <i>Front indicator</i>	➔ 5.41.050.00
		Fanale anteriore <i>Front indicator</i>	➔ 5.41.051.00

IVECO		SERIE Z	
	90→00	Cornice anteriore <i>Front bezel</i>	➔ 2.41.058.01
			➔ 2.41.059.01
		Trasparente anteriore <i>Front lens</i>	➔ 2.41.058.27
			➔ 2.41.059.27
* Ricambio di qualità equivalente <i>Matching quality spare parts</i>			

IVECO		SERIE Z	
	87→	Trasparente anteriore incolore <i>Front clear lens</i>	➔ 2.41.126.25
		Trasparente anteriore incolore <i>Front clear lens</i>	➔ 2.41.127.25
* Ricambio di qualità equivalente <i>Matching quality spare parts</i>			

IVECO		STRALIS	
	03→	Fanale anteriore <i>Front indicator</i>	➔ 2.41.066.00
		Fanale anteriore <i>Front indicator</i>	➔ 2.41.067.00
* Ricambio di qualità equivalente <i>Matching quality spare parts</i>			

IVECO		STRALIS	
	07→	Fanale anteriore arancio <i>Orange Front indicator</i>	→ 2.41.050.00
		Fanale anteriore arancio <i>Orange Front indicator</i>	← 2.41.051.00
	* Ricambio di qualità equivalente <i>Matching quality spare parts</i>		

IVECO		STRALIS	
	07→	Fanale anteriore incolore <i>Clear Front indicator</i>	→ 2.41.094.00
		Fanale anteriore incolore <i>Clear Front indicator</i>	← 2.41.095.00
	* Ricambio di qualità equivalente <i>Matching quality spare parts</i>		

IVECO		STRALIS	
	→ 07	Fanale anteriore <i>Front indicator</i>	→ 2.41.054.00
		Fanale anteriore <i>Front indicator</i>	← 2.41.054.00
	* Ricambio di qualità equivalente <i>Matching quality spare parts</i>		

IVECO		TURBO STAR	
	84→	Fanale anteriore <i>Front indicator</i>	→ 2.42.050.00
		Fanale anteriore <i>Front indicator</i>	← 2.42.050.00
	* Ricambio di qualità equivalente <i>Matching quality spare parts</i>		

IVECO		190 TURBO	
	82→	Fanale anteriore <i>Front lamp</i>	→ 1.41.052.00
		Fanale anteriore <i>Front lamp</i>	← 1.41.053.00
	82→	Trasparente <i>Lens</i>	→ 1.41.052.24
		Trasparente <i>Lens</i>	← 1.41.053.24

MAN		F 2000	
	94→	Fanale anteriore <i>Front indicator</i>	↔ ↔ 2.41.062.00
		* Ricambio di qualità equivalente Matching quality spare parts	
MAN		TGA TGX TGL	
		Fanale anteriore arancio <i>Orange Front indicator</i>	↔ ↔ 2.41.070.00
		Fanale anteriore incolore <i>Clear Front indicator</i>	↔ ↔ 2.41.072.00
		* Ricambio di qualità equivalente Matching quality spare parts	
MERCEDES		ACTROS	
		Fanale anteriore <i>Front indicator</i>	↔ ↔ 2.41.074.00
		* Ricambio di qualità equivalente Matching quality spare parts	
MERCEDES		AXOR	
	04→	Fanale anteriore <i>Front indicator</i>	↔ 2.41.064.00
		Fanale anteriore <i>Front indicator</i>	↔ 2.41.065.00
		* Ricambio di qualità equivalente Matching quality spare parts	
MERCEDES		ACTROS AXOR	
		Fanale anteriore <i>Front indicator</i>	↔ ↔ 2.41.080.00
		* Ricambio di qualità equivalente Matching quality spare parts	

MERCEDES		ATEGO II	
	04→	Fanale anteriore <i>Front indicator</i>	➔ 2.41.088.00
		Fanale anteriore <i>Front indicator</i>	➔ 2.41.089.00
	* Ricambio di qualità equivalente <i>Matching quality spare parts</i>		

MERCEDES		EVOBUS	
		Fanale anteriore <i>Front indicator</i>	➔ 4.41.054.00
		Fanale anteriore <i>Front indicator</i>	➔ 4.41.055.00
	* Ricambio di qualità equivalente <i>Matching quality spare parts</i>		

MERCEDES		SPRINTER T1 - TN	
	95→00	Fanale anteriore incolore <i>Clear Front indicator</i>	➔ 2.41.096.00
		Fanale anteriore incolore <i>Clear Front indicator</i>	➔ 2.41.097.00
	* Ricambio di qualità equivalente <i>Matching quality spare parts</i>		

MERCEDES		VITO	
	96→03	Gruppo ottico anteriore arancio <i>Orange optical unit</i>	➔ 2.41.122.11
		Gruppo ottico anteriore arancio <i>Orange optical unit</i>	➔ 2.41.123.11
	* Ricambio di qualità equivalente <i>Matching quality spare parts</i>		

MERCEDES		VITO	
	96→03	Gruppo ottico anteriore incolore <i>Clear Front optical unit</i>	➔ 2.41.122.12
		Gruppo ottico anteriore incolore <i>Clear Front optical unit</i>	➔ 2.41.123.12
	* Ricambio di qualità equivalente <i>Matching quality spare parts</i>		

NISSAN		ATLEON	
	06→	Fanale direzione arancio <i>Orange repeater lamp</i>	→ 5.41.084.00
		Fanale direzione arancio <i>Orange repeater lamp</i>	← 5.41.085.00

NISSAN		CABSTAR	
	98→02	Gruppo ottico anteriore <i>Front optical unit</i>	→ 2.41.068.10
		Gruppo ottico anteriore <i>Front optical unit</i>	← 2.41.069.10
	* Ricambio di qualità equivalente Matching quality spare parts		

NISSAN		CABSTAR	
	01→06	Gruppo ottico anteriore <i>Front optical unit</i>	→ 5.41.080.00
		Gruppo ottico anteriore <i>Front optical unit</i>	← 5.41.081.00

RENAULT		MASTER	
	99→	Fanale anteriore <i>Front indicator</i>	→ 5.41.062.00
		Fanale anteriore <i>Front indicator</i>	← 5.41.063.00

RENAULT		MASTER	
	99→	Fanale anteriore fumé <i>Front indicator fumé</i>	→ 5.41.064.00
		Fanale anteriore fumé <i>Front indicator fumé</i>	← 5.41.065.00

RENAULT		PREMIUM	
	99→	Fanale anteriore <i>Front indicator</i>	→ 2.41.060.00
		Fanale anteriore <i>Front indicator</i>	← 2.41.061.00
	* Ricambio di qualità equivalente <i>Matching quality spare parts</i>		

SCANIA		R	LED 24V
	04→	Fanale anteriore arancio con cavo <i>Orange Front indicator with cable</i>	→ ← 2.42.080.80
		* Ricambio di qualità equivalente <i>Matching quality spare parts</i>	

SCANIA		SERIE 4 114-124	
	95→	Fanale anteriore / <i>Front indicator</i>	→ 2.41.086.27 ← 2.41.087.27
		Cablaggio / <i>Wiring</i>	→ 2.41.086.19
	* Ricambio di qualità equivalente <i>Matching quality spare parts</i>		

SCANIA		SERIE R-P	LED - 24V / 4 LED
	07→	Fanale anteriore <i>Front indicator</i>	→ ← 2.41.092.00
		* Ricambio di qualità equivalente <i>Matching quality spare parts</i>	

SCANIA		SERIE R-P	LED
	09→	Fanale anteriore arancio con DRL Lampade 21W + 4LED + 8LED DRL <i>Orange Front indicator with DRL</i> 21W bulb + 4LED + 8LED DRL	→ ← 2.41.098.80
		* Ricambio di qualità equivalente <i>Matching quality spare parts</i>	

SCANIA VOLVO		BUS	
		Fanale direzione arancio Lampada P21W <i>Orange repeater lamp</i> <i>P21W bulb</i>	→ ← 2.44.244.00
* Ricambio di qualità equivalente Matching quality spare parts			
SCANIA VOLVO		BUS	
		Fanale anteriore incolore Lampada PY21W <i>Clear front lamp</i> <i>PY21W bulb</i>	→ ← 2.44.246.00
* Ricambio di qualità equivalente Matching quality spare parts			
VOLVO		FH-FM	
	93→01	Fanale anteriore incolore <i>Clear front lamp</i>	→ ← 2.41.118.00
* Ricambio di qualità equivalente Matching quality spare parts			
VOLVO		FH12 FL FM	
	98→05	Fanale anteriore <i>Front indicator</i>	→ ← 2.41.082.00
* Ricambio di qualità equivalente Matching quality spare parts			
VOLVO		BUS	
	98→05	Fanale anteriore arancio <i>Orange Front indicator</i>	→ ← 2.41.084.00
* Ricambio di qualità equivalente Matching quality spare parts			

UNIVERSALE		TRATTORI TRACTORS	
	Fanale anteriore <i>Front indicator</i>		2.41.056.00
	Fanale anteriore con base alta <i>Front lamp with high base</i>		2.41.058.00
	* Ricambio di qualità equivalente <i>Matching quality spare parts</i>		



UNIVERSALE		LED 9 33V	
	Fanale anteriore direzione <i>Repeater front lamp</i>		2.41.078.80
	* Ricambio di qualità equivalente <i>Matching quality spare parts</i>		





UNIVERSALE		TRATTORI TRACTORS	
	Fanale anteriore <i>Front indicator</i>		2.41.106.00
	Trasparente <i>Lens</i>		2.41.106.27
	* Ricambio di qualità equivalente <i>Matching quality spare parts</i>		

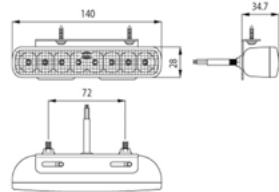



UNIVERSALE			
	Fanale anteriore <i>Front lamp</i>	 	2.41.112.00
	Trasparente anteriore <i>Front lens</i>	 	2.41.112.27
	* Ricambio di qualità equivalente <i>Matching quality spare parts</i>		







UNIVERSALE			
	Fanale anteriore <i>Front lamp</i>	 	2.41.113.00
	Trasparente anteriore <i>Front lens</i>	 	2.41.113.27
	* Ricambio di qualità equivalente <i>Matching quality spare parts</i>		

UNIVERSALE			
	Fanale direzione anteriore Arancio Repeater Orange lamp		2.41.076.00
* Ricambio di qualità equivalente Matching quality spare parts			





UNIVERSALE		LED 9 33V	
	Luce diurna Day running light		2.47.092.80
			

UNIVERSALE		LED 9 33V	
	Fanale anteriore Flashing arancio / Flashing front lamp orange		2.47.080.80
	Fanale anteriore Flashing blu / Flashing front lamp blue		2.47.081.80
	Fanale anteriore Flashing incolore / Flashing front lamp clear		2.47.082.80
	64,3x35 mm. - 3 LED		

UNIVERSALE		LED 9 33V	
	Fanale anteriore Flashing incolore Flashing front lamp clear	 	2.47.086.80
101,5x22,4 mm. - 6 LED			

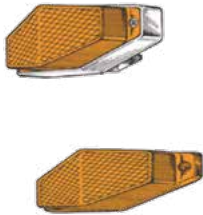

UNIVERSALE		LED 9 33V	
	Fanale anteriore Flashing arancio Flashing front lamp orange		2.47.088.80
	Fanale anteriore Flashing blu Flashing front lamp blue		2.47.089.80
	Fanale anteriore Flashing incolore Flashing front lamp clear		2.47.090.80
144,8x26,9 mm. - 6 LED			

FIAT		690	
	Fanale laterale <i>Side lamp</i>	 	2.42.066.00
	Trasparente <i>Lens</i>	 	2.42.066.24
	Corpo nero <i>Black body</i>	* Ricambio di qualità equivalente <i>Matching quality spare parts</i>	

FIAT		690	
	Fanale laterale <i>Side lamp</i>	 	2.42.070.00
	Trasparente <i>Lens</i>	 	2.42.066.24
	Corpo cromato <i>Chrome body</i>	* Ricambio di qualità equivalente <i>Matching quality spare parts</i>	

FIAT		619 - 690 - 693	
	Fanale laterale - Corpo cromato dist. mm. 40 <i>Side lamp - Chrome body</i>	 	2.42.120.00
	Fanale laterale - Corpo nero dist. mm. 40 <i>Side lamp - Black body</i>	 	2.42.122.00
	* Ricambio di qualità equivalente <i>Matching quality spare parts</i>		

FIAT		625 - 645 N1/T	
	Fanale laterale / <i>Side lamp</i>	 	2.42.117.00
	Fanale laterale / <i>Side lamp</i>	 	2.42.118.00
	Trasparente arancio / <i>Orange lens</i>	 	2.42.118.24
	* Ricambio di qualità equivalente <i>Matching quality spare parts</i>		

FIAT		DUCATO		
	→90	Fanale laterale <i>Side lamp</i>	 	1.42.050.00
		* Ricambio di qualità equivalente <i>Matching quality spare parts</i>		

FIAT		DUCATO		
	→90	Fanale laterale <i>Side lamp</i>	↔	1.42.052.00
		* Ricambio di qualità equivalente <i>Matching quality spare parts</i>		

FIAT		DUCATO		
	94→00	Fanale laterale <i>Side lamp</i>	↔	1.42.054.00
		* Ricambio di qualità equivalente <i>Matching quality spare parts</i>		

FIAT		DUCATO		
	02→	Gruppo ottico laterale <i>Side optical unit</i>	↔	1.42.058.11
		* Ricambio di qualità equivalente <i>Matching quality spare parts</i>		

FIAT		DUCATO		
	06→	Gruppo ottico laterale su specchio retrovisore <i>Side optical unit on rear view mirror</i>	→	5.42.056.12
		Gruppo ottico laterale su specchio retrovisore <i>Side optical unit on rear view mirror</i>	←	5.42.057.12
		* Ricambio di qualità equivalente <i>Matching quality spare parts</i>		

FIAT		DUCATO		
	06→	Gruppo ottico laterale su specchio retrovisore <i>Side optical unit on rear view mirror</i>	→	5.42.058.12
		Gruppo ottico laterale su specchio retrovisore <i>Side optical unit on rear view mirror</i>	←	5.42.059.12
		* Ricambio di qualità equivalente <i>Matching quality spare parts</i>		

FORD		TRANSIT MK VII	
	06→	Fanale laterale <i>Side lamp</i>	➔ 5.42.054.00
		Fanale laterale <i>Side lamp</i>	➔ 5.42.055.00
	Distanziale mm. 640 Spacer mm. 640		

FORD		TRANSIT V363	
	14→	Gruppo ottico lat. su specchio incolore <i>Side clear optical unit on mirror</i>	➔ 2.42.124.11
		Gruppo ottico lat. su specchio incolore <i>Side clear optical unit on mirror</i>	➔ 2.42.125.11
	* Ricambio di qualità equivalente <i>Matching quality spare parts</i>		

FORD		TRANSIT MK VII	
	14→	Gruppo ottico lat. su specchio arancio <i>Side orange optical unit on mirror</i>	➔ 2.42.124.12
		Gruppo ottico lat. su specchio arancio <i>Side orange optical unit on mirror</i>	➔ 2.42.125.12
	* Ricambio di qualità equivalente <i>Matching quality spare parts</i>		

FORD		TRANSIT CUSTOM V362	
	12→	Gruppo ottico lat. su specchio incolore <i>Side clear optical unit on mirror</i>	➔ 2.42.126.11
		Gruppo ottico lat. su specchio incolore <i>Side clear optical unit on mirror</i>	➔ 2.42.127.11
	* Ricambio di qualità equivalente <i>Matching quality spare parts</i>		

IVECO		BUS	
 		Fanale laterale ingombro W5W <i>W5W Side lamp drive marker</i>	2.43.048.00
		Portalampade / <i>Bulb holder</i>	2.43.048.18
	* Ricambio di qualità equivalente <i>Matching quality spare parts</i>		

IVECO		DAILY OM		
	→96	Fanale laterale <i>Side lamp</i>	↔	1.42.060.00

IVECO		DAILY S.2000		
	99→05	Fanale laterale <i>Side lamp</i>	→	1.42.062.00
		Fanale laterale <i>Side lamp</i>	←	1.42.063.00

IVECO		DAILY S.2000		
	99→05	Fanale laterale <i>Side lamp</i>	→	1.42.066.00
		Fanale laterale <i>Side lamp</i>	←	1.42.067.00

IVECO		DAILY S.2000		
	04→	Fanale laterale <i>Side lamp</i>	→	1.42.064.00
		Fanale laterale <i>Side lamp</i>	←	1.42.065.00

IVECO		DAILY S.2000		
	04→	Fanale laterale <i>Side lamp</i>	→	1.42.068.00
		Fanale laterale <i>Side lamp</i>	←	1.42.069.00

IVECO		DAILY	
	06→12	Gruppo ottico laterale su specchio retrovisore <i>Side optical unit on rear view mirror</i>	 2.42.060.12
		Gruppo ottico laterale su specchio retrovisore <i>Side optical unit on rear view mirror</i>	 2.42.061.12
	* Ricambio di qualità equivalente <i>Matching quality spare parts</i>		

IVECO		DAILY 2014	
	12→	Gruppo ottico laterale su specchietto <i>Side optical unit [on mirror]</i>	 2.42.068.12
		Gruppo ottico laterale su specchietto <i>Side optical unit [on mirror]</i>	 2.42.069.12
	* Ricambio di qualità equivalente <i>Matching quality spare parts</i>		

IVECO		EUROCARGO	
	→04	Fanale laterale <i>Side lamp</i>	 1.42.070.00
			

IVECO		EUROCARGO	
	→04	Fanale laterale <i>Side lamp</i>	 1.42.072.00
			

IVECO		EUROCARGO	
	04→	Fanale anteriore <i>Front lamp</i>	 2.42.104.00
			
* Ricambio di qualità equivalente <i>Matching quality spare parts</i>			

IVECO		EUROCARGO	
	04→12	Fanale anteriore <i>Front lamp</i>	↔ ↔ 2.42.106.00
		* Ricambio di qualità equivalente Matching quality spare parts	

IVECO		EUROTECH	
	→93	Fanale laterale <i>Side lamp</i>	↔ ↔ 1.42.074.00 1.42.075.00
		Trasparente laterale <i>Side lens</i>	↔ ↔ 1.42.074.24 1.42.075.24

IVECO		EUROTECH EUROSTAR STRALIS	
	99→04	Fanale laterale arancio / <i>Orange side lamp</i>	↔ ↔ 5.42.050.00
		Fanale laterale arancio / <i>Orange side lamp</i>	↔ ↔ 2.42.076.00
		Portalamпада / <i>Bulb holder</i>	2.42.076.18

IVECO		EUROTECH	
	93→	Fanale laterale <i>Side lamp</i>	↔ ↔ 1.42.076.00 1.42.077.00
		Gruppo ottico laterale <i>Side optical unit</i>	↔ ↔ 1.42.076.11 1.42.077.11

IVECO		SERIE Z	
		Fanale laterale <i>Side lamp</i>	↔ 2.42.074.00
		Fanale laterale <i>Side lamp</i>	↔ 2.42.075.00
	* Ricambio di qualità equivalente Matching quality spare parts		

IVECO		STRALIS EUROSTAR IRISBUS	
	00→	Fanale laterale / Side lamp	5.42.070.00
		Fanale laterale / Side lamp	2.42.076.00
		Portalampada / Bulb holder	2.42.078.18
		Con attacco superseal With superseal connection	

IVECO		EUROTECH EUROSTAR STRALIS	
	99→04	Fanale laterale incolore / Clear side lamp	  5.43.056.00
		Fanale laterale incolore / Clear side lamp	  2.42.078.00

IVECO		STRALIS	
	03→	Fanale laterale arancio Orange side lamp	 2.42.080.00
		Fanale laterale arancio Orange side lamp	 2.42.081.00
	3 fori corpo grigio 3 holes grey body	* Ricambio di qualità equivalente Matching quality spare parts	

IVECO		STRALIS	
	03→	Fanale laterale arancio Orange side lamp	 2.42.084.00
		Fanale laterale arancio Orange side lamp	 2.42.085.00
	3 fori corpo nero 3 holes black body	* Ricambio di qualità equivalente Matching quality spare parts	

IVECO		STRALIS	
	03→	Fanale laterale arancio Orange side lamp	 2.42.090.00
		Fanale laterale arancio Orange side lamp	 2.42.091.00
	2 fori corpo nero 2 holes black body	* Ricambio di qualità equivalente Matching quality spare parts	

IVECO		STRALIS	
	03→	Fanale laterale incolore <i>Clear side lamp</i>	→ 2.42.086.00
		Fanale laterale incolore <i>Clear side lamp</i>	← 2.42.087.00
	3 fori corpo nero <i>3 holes black body</i>		* Ricambio di qualità equivalente <i>Matching quality spare parts</i>



IVECO		STRALIS	
	03→	Fanale laterale incolore <i>Clear side lamp</i>	→ 2.42.088.00
		Fanale laterale incolore <i>Clear side lamp</i>	← 2.42.089.00
	3 fori corpo grigio <i>3 holes grey body</i>		* Ricambio di qualità equivalente <i>Matching quality spare parts</i>





IVECO		EUROCARGO - STRALIS	
	12→	Fanale anteriore incolore <i>Clear side lamp</i>	→ 2.42.072.00
		Fanale anteriore incolore <i>Clear side lamp</i>	← 2.42.073.00
	Corpo nero 2 fori <i>2 holes black body</i>		* Ricambio di qualità equivalente <i>Matching quality spare parts</i>



IVECO		VARIUS	
		Fanale laterale <i>Side lamp</i>	2.42.102.00
		Trasparente <i>Lens</i>	2.42.102.24
	* Ricambio di qualità equivalente <i>Matching quality spare parts</i>		

MAN		BUS	
		Fanale laterale arancio <i>Orange side lamp</i>	→ ← 2.42.116.00
	* Ricambio di qualità equivalente <i>Matching quality spare parts</i>		

MAN		F 2000 TRANSIT		LED 24V
		Fanale laterale <i>Side lamp</i>	↔	4.42.060.80
<hr/>				
MAN		TGA TGM TGL L2000		LED 24V
	04→	Fanale anteriore incolore con cavo <i>Clear Front indicator with cable</i>	↔	2.42.082.80
* Ricambio di qualità equivalente <i>Matching quality spare parts</i>				
<hr/>				
MERCEDES		ACTROS		LED 24V
		Fanale laterale <i>Side lamp</i>	↔	4.42.056.80
<hr/>				
MERCEDES		ACTROS		LED 24V
	00→	Fanale laterale <i>Side lamp</i>	↔	2.42.058.80
* Ricambio di qualità equivalente <i>Matching quality spare parts</i>				
<hr/>				
MERCEDES		ATEGO I-II		
		Fanale direzione anteriore arancio <i>Orange front repeater lamp</i>	→	2.42.096.00
	98→	Fanale direzione anteriore arancio <i>Orange front repeater lamp</i>	←	2.42.097.00
* Ricambio di qualità equivalente <i>Matching quality spare parts</i>				

MERCEDES		AXOR ACTROS		
	02→	Gruppo ottico laterale <i>Side optical unit</i>	 	2.42.056.11
		* Ricambio di qualità equivalente <i>Matching quality spare parts</i>		

MERCEDES		SPRINTER II CRAFTER		
	05→06	Fanale laterale 1990-2100-2300 / <i>Side lamp 1990-2100-2300</i>		5.42.062.00
		Fanale laterale 1990 / <i>Side lamp 1990</i>		5.42.063.00
		Fanale laterale 2100-2300 / <i>Side lamp 2100-2300</i>		5.42.065.00
		Lampada PH16WY 12V / <i>Bulb PH16WY 12V</i>		5.42.062.99
		Su retrovisore <i>On rear view mirror</i>		

MERCEDES		BUS		LED 24V	
		Fanale ingombro <i>Side marker</i>	 	2.42.064.80	
		* Ricambio di qualità equivalente <i>Matching quality spare parts</i>			

MERCEDES		BUS		LED	
		Fanale laterale incolore Led arancio <i>Clear side lamp</i> <i>Orange led</i>		4.42.062.80	

RENAULT		GAMMA C-J		
	01→	Fanale laterale rosso - incolore <i>Side lamp red - clear</i>		5.42.078.00
		Fanale laterale arancio <i>Orange side marker</i>		5.42.080.00
	Lampada T4W <i>Bulb T4W</i>			

RENAULT		PREMIUM MIDLUM	
	00→	Gruppo ottico direzione su pedana nero <i>Direction optical unit on black platform</i>	→ 5.43.058.00
		Portalampane <i>Light bulb holder</i>	1.09.052.00

RENAULT		PREMIUM	
	97→	Gruppo ottico direzione su pedana nero <i>Direction optical unit on black platform</i>	↔ 2.43.218.00
		Portalampane <i>Light bulb holder</i>	1.09.052.00
	* Ricambio di qualità equivalente <i>Matching quality spare parts</i>		



SCANIA		R-P	
	07→	Fanale laterale con catadiottro <i>Side lamp with reflex-reflector</i>	↔ 2.42.092.00
	* Ricambio di qualità equivalente <i>Matching quality spare parts</i>		

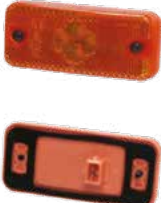

SETRA		BUS		LED 24V	
		Fanale laterale <i>Side lamp</i>	↔	2.42.062.80	
	* Ricambio di qualità equivalente <i>Matching quality spare parts</i>				





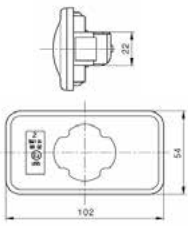

VOLVO		BUS COACH		LED 24V	
	00→	Fanale laterale 4 led <i>Side lamp 4 LED</i>		5.42.072.80	
		Fanale laterale 4 led <i>Side lamp 4 LED</i>		2.42.108.80	

VOLVO		BUS		LED
		Fanale laterale incolore <i>Clear side lamp</i>	↔	2.42.110.80
		* Ricambio di qualità equivalente Matching quality spare parts		

VOLVO SCANIA		FH FM S3/4		LED 24V
 		Fanale laterale <i>Side lamp</i>	↔	4.42.054.80
		Fanale laterale ingombro <i>Side lamp driver marker</i>		2.42.100.80
		* Ricambio di qualità equivalente Matching quality spare parts		

VOLVO		FH16 FM		
 		Fanale laterale / <i>Side lamp</i>	→	2.42.054.00
		Fanale laterale / <i>Side lamp</i>	←	2.42.055.00
	02→	Fanale laterale / <i>Side lamp</i>	→	2.42.052.00
		Fanale laterale / <i>Side lamp</i>	←	2.42.053.00
		* Ricambio di qualità equivalente Matching quality spare parts		

VOLVO		BUS COACH		LED 24V
 		Fanale laterale <i>Side lamp</i>		5.42.076.80
	01→	Fanale laterale ingombro <i>Side lamp driver marker</i>		2.42.098.80
		* Ricambio di qualità equivalente Matching quality spare parts		

DAF IVECO MAN MERCEDES			LED 24V
		Segnalatore ingombro cabina LED <i>LED driver's cab side marker</i>	→ ← 4.43.058.80
DAF	XF	LED	
		Fanale ingombro con cavo <i>Side marker with cable</i>	2.43.091.80
* Ricambio di qualità equivalente <i>Matching quality spare parts</i>			
FIAT IVECO			
		Segnalatore ingombro cabina <i>Driver's cab side marker</i>	→ ← 1.43.058.00
		Segnalatore ingombro <i>Side marker</i>	→ ← 1.43.060.00
IVECO	DAILY S. 2000 DAILY MY 2006		
		Segnalatore ingombro cabina <i>Driver's cab side marker</i>	→ 1.43.050.00
	99→	Segnalatore ingombro cabina <i>Driver's cab side marker</i>	← 1.43.051.00
IVECO	DAILY 2014		
		Fanale ingombro cabina <i>Driver cab marker</i>	→ 5.43.062.00
	14→	Fanale ingombro cabina <i>Driver cab marker</i>	← 5.43.063.00



IVECO		EUROCARGO EUROTECH	
	91→	Segnalatore Marker	→ 1.43.052.00
		Segnalatore Marker	← 1.43.053.00

IVECO		EUROCARGO	
	91→	Segnalatore ingombro cabina Driver's cab side marker	→ ← 1.43.054.00



IVECO		EUROCARGO	
	91→	Segnalatore ingombro cabina Driver's cab side marker	→ ← 1.43.056.00

IVECO		EUROCARGO	
	03→	Segnalatore ingombro cabina Driver's cab side marker	→ 1.43.076.00
		Segnalatore ingombro cabina Driver's cab side marker	← 1.43.077.00

IVECO		STRALIS	
	03→	Segnalatore ingombro cabina Driver's cab side marker	→ 1.43.068.00
		Segnalatore ingombro cabina Driver's cab side marker	← 1.43.069.00







IVECO		STRALIS	
	10→	Segnalatore ingombro cabina <i>Driver's cab side marker</i>	 1.43.078.00
		Segnalatore ingombro cabina <i>Driver's cab side marker</i>	 1.43.079.00



IVECO		STRALIS		LED 24V
	10→	Ingombro visiera LED <i>LED sun visor's marker</i>	 1.43.080.80	
		Ingombro visiera LED <i>LED sun visor's marker</i>	 1.43.081.80	

IVECO		STRALIS EUROCARGO	
	91→	Segnalatore <i>Marker</i>	  1.43.064.00

IVECO		STRALIS EUROCARGO EUROTECH	
	91→	Segnalatore ingombro cabina <i>Driver's cab side marker</i>	 1.43.072.00
		Segnalatore ingombro cabina <i>Driver's cab side marker</i>	 1.43.073.00

IVECO		STRALIS EUROCARGO EUROTECH	
	91→	Ingombro visiera <i>Sun visor's marker</i>	 1.43.074.00
		Ingombro visiera <i>Sun visor's marker</i>	 1.43.075.00

IVECO		STRALIS			
	03→	Segnalatore ingombro cabina <i>Driver's cab side marker</i>	→	1.43.070.00	
		Segnalatore ingombro cabina <i>Driver's cab side marker</i>	←	1.43.071.00	
EVOBUS SETRA		315 H			LED 24V
	05→	Fanale ingombro laterale <i>Side lamp driver marker</i>	→ ←	2.43.052.80	
		* Ricambio di qualità equivalente <i>Matching quality spare parts</i>			
MAN		TGA			LED 24V
		Fanale ingombro cabina LED <i>LED driver cab marker</i>	→ ←	2.43.132.80	
		* Ricambio di qualità equivalente <i>Matching quality spare parts</i>			
RENAULT		PREMIUM MIDLUM			
	00→	Luce ingombro anteriore <i>Front marker lamp</i>		5.43.060.00	
SCANIA		SERIE R			LED 24V
 	09→	Ingombro visiera incolore LED <i>Clear LED sun visor's marker</i>	→ ←	2.43.140.80	
		Ingombro visiera arancio LED <i>Orange LED sun visor's marker</i>	→ ←	2.43.141.80	
	* Ricambio di qualità equivalente <i>Matching quality spare parts</i>				

VOLVO	FH/FM	LED 24V
	13→ Fanale ingombro cabina arancio <i>Orange driver cab marker</i>	5.43.064.80
	Fanale ingombro cabina incolore <i>Clear driver cab marker</i>	5.43.065.80
	Fanale ingombro cabina fumè <i>Smoked driver cab marker</i>	5.43.066.80
		

VOLVO	FH-FM	LED
	14→ Fanale laterale <i>Side lamp</i>	 5.43.068.80
	Fanale laterale <i>Side lamp</i>	 5.43.069.80
		

VOLVO	FH-FM	LED
	14→ Fanale laterale <i>Side lamp</i>	 5.43.070.80
	Fanale laterale <i>Side lamp</i>	 5.43.071.80
		

VOLVO	FH (FH13)	LED 24V
	Fanale laterale arancio <i>Side lamp orange</i>	 2.43.130.80
	Fanale laterale arancio <i>Side lamp orange</i>	 2.43.131.80

UNIVERSALE	FLATPOINT	
	Fanale laterale con cavo cm 50 staffa e protezione <i>Side lamp with 50 cm cable bracket and protection</i>	7.43.060.31

UNIVERSALE	BUS	
	Segnalatore ingombro arancio / <i>Orange side marker</i>	2.43.048.00
	Gruppo ottico ingombro arancio / <i>Orange side optical unit</i>	2.43.048.11
	Segnalatore ingombro incolore / <i>Clear side marker</i>	2.43.040.00
	Gruppo ottico ingombro incolore / <i>Clear side optical unit</i>	2.43.048.22
	Segnalatore ingombro rosso / <i>Red side marker</i>	2.43.042.00
	Gruppo ottico ingombro rosso / <i>Red side optical unit</i>	2.43.048.21
	Portalampade / <i>Bulb holder</i>	2.43.048.18
	Segnalatore ingombro arancio / <i>Orange side marker</i>	2.43.318.00
	Segnalatore ingombro incolore / <i>Clear side marker</i>	2.43.320.00
	Segnalatore ingombro rosso / <i>Red side marker</i>	2.43.322.00
	Portalampade / <i>Bulb holder</i>	1.09.050.00
	* Ricambio di qualità equivalente Matching quality spare parts	

UNIVERSALE		
	Segnalatore ingombro arancio con catadiottro <i>Orange side marker with reflector</i>	2.43.272.00
	Segnalatore ingombro rosso <i>Red side marker</i>	2.43.274.00
	Segnalatore ingombro incolore <i>Clear side marker</i>	2.43.276.00
	Portalampade <i>Bulb holder</i>	1.09.050.00
	* Articolo universale Universal part mm. 80x44	

UNIVERSALE

Segnalatore ingombro con catadiottro arancio <i>Side marker with orange reflector</i>	2.43.278.00
Segnalatore ingombro con catadiottro rosso <i>Side marker with red reflector</i>	2.43.280.00
Segnalatore ingombro con catadiottro incolore <i>Side marker with clear reflector</i>	2.43.282.00
Portalampade <i>Bulb holder</i>	1.09.050.00

* **Ricambio di qualità equivalente** | **Matching quality spare parts** mm. 80x44

UNIVERSALE

Segnalatore ingombro arancio - 1 passacavo <i>Orange side marker - 1 fairlead</i>	2.43.308.00
Segnalatore ingombro rosso - 1 passacavo <i>Red side marker - 1 fairlead</i>	2.43.310.00
Segnalatore ingombro incolore - 1 passacavo <i>Clear side marker - 1 fairlead</i>	2.43.312.00
Segnalatore ingombro arancio - 1 passacavo con staffa <i>Orange side marker - 1 fairlead with bracket</i>	2.43.314.00
Segnalatore ingombro arancio - 1 passacavo con staffa <i>Orange side marker - 1 fairlead with bracket</i>	2.43.316.00

* **Articolo universale** | **Universal part** mm. 112x50

UNIVERSALE

Segnalatore ingombro arancio <i>Orange side marker</i>	2.43.294.00
Segnalatore ingombro incolore <i>Clear side marker</i>	2.43.296.00
Segnalatore ingombro arancio con staffa <i>Orange side marker with bracket</i>	2.43.298.00
Segnalatore ingombro incolore con staffa <i>Clear side marker with bracket</i>	2.43.300.00
Portalampade <i>Bulb holder</i>	1.09.050.00

* **Ricambio di qualità equivalente** | **Matching quality spare parts**

UNIVERSALE

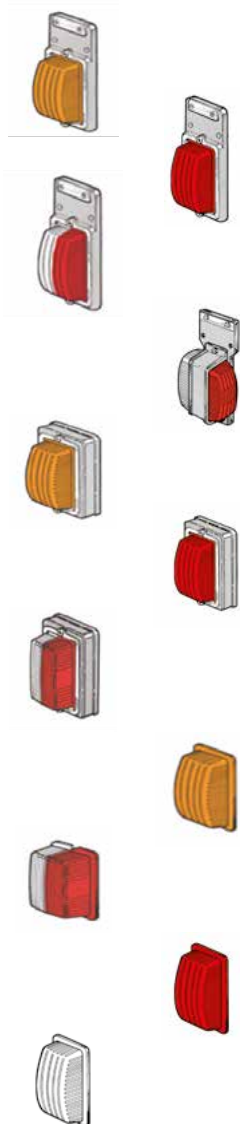

Segnalatore ingombro arancio <i>Orange driver's side marker</i>	2.43.142.00
Segnalatore ingombro rosso <i>Red side marker</i>	2.43.143.00
Segnalatore ingombro rosso incolore <i>Red clear driver's side marker</i>	2.43.144.00
Segnalatore ingombro rosso incolore <i>Red clear side marker</i>	2.43.145.00
Segnalatore arancio <i>Orange indicator</i>	2.43.146.00
Segnalatore ingombro rosso <i>Red side marker</i>	2.43.147.00
Segnalatore rosso incolore <i>Red clear indicator</i>	2.43.148.00
Trasparente arancio <i>Orange lens</i>	2.43.142.24
Trasparente rosso incolore <i>Red clear lens</i>	2.43.142.26
Trasparente rosso <i>Red lens</i>	2.43.142.22
Trasparente incolore <i>Clear lens</i>	2.43.142.25

* **Articolo universale | Universal part**

UNIVERSALE



Sidemarker arancio senza catadiottro con staffa <i>Orange side marker without reflector with bracket</i>	2.43.250.00
Sidemarker rosso senza catadiottro con staffa <i>Red side marker without reflector with bracket</i>	2.43.252.00
Sidemarker incolore senza catadiottro con staffa <i>Clear side marker without reflector with bracket</i>	2.43.248.00

* **Articolo universale | Universal part**

UNIVERSALE

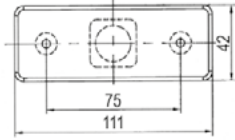

Sidemarker base piana con catadiottro <i>Flat base side marker with reflector</i>	2.43.099.00
Trasparente <i>Lens</i>	2.43.098.24
Sidemarker con catadiottro e staffa <i>Side marker with reflector and bracket</i>	2.43.098.00
* Ricambio di qualità equivalente Matching quality spare parts	

UNIVERSALE

Fanale ingombro con catadiottro arancio <i>Side marker with orange reflector</i>		2.43.062.40
Portalampane <i>Light bulb holder</i>		2.43.064.18
* Ricambio di qualità equivalente Matching quality spare parts		

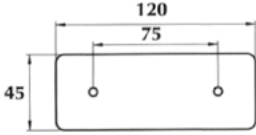
UNIVERSALE

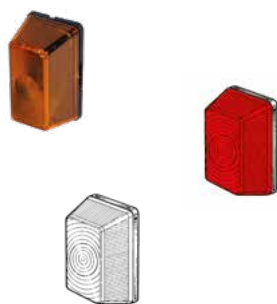
Fanale ingombro con catadiottro arancio <i>Side marker with orange reflector</i>		2.43.066.40
Portalampane <i>Light bulb holder</i>		2.43.064.18
* Ricambio di qualità equivalente Matching quality spare parts		

UNIVERSALE

Fanale ingombro <i>senza catadiottro</i> <i>Side marker</i>	2.43.100.00
Trasparente <i>Lens</i>	2.43.100.24
Segnalatore ingombro rosso <i>Red side marker</i>	2.43.102.00
Segnalatore ingombro incolore <i>Clear side marker</i>	2.43.103.00
* Articolo universale Universal part	

UNIVERSALE

Segnalatore ingombro arancio <i>Orange side marker</i>	2.43.149.00
Segnalatore ingombro arancio con staffa <i>Orange side marker with bracket</i>	2.43.325.00
Trasparente <i>Lens</i>	2.43.149.24
* Articolo universale Universal part	



UNIVERSALE



Segnalatore ingombro arancio <i>Orange side marker</i>	2.43.220.00
Trasparente arancio <i>Orange lens</i>	2.43.220.24
Segnalatore ingombro rosso <i>Red side marker</i>	2.43.221.00
Trasparente rosso <i>Red lens</i>	2.43.220.22
Segnalatore ingombro incolore <i>Clear side marker</i>	2.43.222.00
Trasparente incolore <i>Clear lens</i>	2.43.220.25
* Articolo universale Universal part	

UNIVERSALE





Segnalatore ingombro incolore rosso <i>Red clear side marker</i>	2.43.224.00
Trasparente incolore rosso <i>Red clear lens</i>	2.43.224.26
Segnalatore ingombro rosso <i>Red side marker</i>	2.43.226.00
Trasparente rosso <i>Red lens</i>	2.43.220.22
Segnalatore ingombro arancio <i>Orange side marker</i>	2.43.228.00
Trasparente arancio <i>Orange lens</i>	2.43.220.24
Segnalatore ingombro incolore <i>Clear side marker</i>	2.43.230.00
Trasparente incolore <i>Clear lens</i>	2.43.220.25
* Articolo universale Universal part	



UNIVERSALE



Segnalatore ingombro rosso incolore <i>Red clear side marker</i>	2.43.284.00
Segnalatore ingombro arancio <i>Orange side marker</i>	2.43.286.00
* Articolo universale Universal part	

UNIVERSALE	AUTOBUS	
	Fanale ingombro cabina incolore <i>Clear driver cab marker</i>	2.43.112.00
	Fanale ingombro cabina rosso <i>Red driver cab marker</i>	2.43.114.00
	* Articolo universale Universal part	

UNIVERSALE		
	Segnalatore ingombro rosso incolore - base in gomma <i>Red clear side marker - Rubber base</i>	2.43.268.00
	Trasparente rosso incolore <i>Red clear lens</i>	2.43.224.26
	Segnalatore ingombro rosso-incolore - base in gomma <i>Red clear side marker - rubber base</i>	2.43.270.00
	Trasparente incolore <i>Clear lens</i>	2.43.220.25
	Segnalatore ingombro rosso incolore <i>Red clear side marker</i>	2.43.266.00
	* Articolo universale Universal part	

UNIVERSALE		
	Fanale ingombro arancio <i>Orange side marker</i>	5.43.054.00
Con passacavo - dimensioni 950x200 mm. - Lampada <i>Bulb T4W</i>		
		



UNIVERSALE

	Fanale ingombro con cavo <i>Side marker with cable</i>	→	2.43.044.00
	Fanale ingombro con cavo <i>Side marker with cable</i>	←	2.43.045.00
	Fanale ingombro braccio gomma rosso - incolore <i>Side marker with red - clear rubber arm</i>	→	2.43.050.00
	Fanale ingombro braccio gomma rosso - incolore <i>Side marker with red - clear rubber arm</i>	←	2.43.051.00
	Fanale ingombro con cavo <i>Side marker with cable</i>		2.43.047.00
	Fanale ingombro con cavo <i>Side marker with cable</i>		2.43.049.00
	Fanale ingombro con cavo <i>Side marker with cable</i>		2.43.046.00
	Gruppo ottico ingombro <i>Side optical unit</i>		2.43.044.10
	Con cavo 50 cm. <i>With cable 50 cm.</i>	* Ricambio di qualità equivalente Matching quality spare parts	

UNIVERSALE

	Fanale ingombro braccio gomma rosso - incolore <i>Side marker with red - clear rubber arm</i>		2.43.126.00
	Fanale ingombro braccio gomma rosso - incolore <i>Side marker with red - clear rubber arm</i>		2.43.074.00
	Fanale ingombro rosso - incolore <i>Side marker with red - clear rubber arm</i>		2.43.072.00
	Fanale ingombro rosso - incolore <i>Side marker with red - clear rubber arm</i>		2.43.080.00
	Fanale ingombro braccio gomma rosso - incolore <i>Side marker with red - clear rubber arm</i>		2.43.082.00
	Trasparente incolore <i>Clear lens</i>		2.43.072.25
	Trasparente rosso <i>Red Lens</i>		2.43.072.22
	Portalampade <i>Light bulb holder</i>		2.43.072.18
	* Ricambio di qualità equivalente Matching quality spare parts		

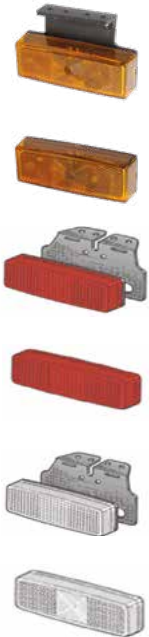
UNIVERSALE	SUPERPOINT II		
	Fanale ingombro con cavo 40 cm <i>Side marker with 40 cm cable</i>	➔	7.43.056.00
	Fanale ingombro con cavo 40 cm <i>Side marker with 40 cm cable</i>	➔	7.43.057.00

UNIVERSALE			
	Fanale ingombro arancio con staffa - con catadiottro <i>Orange side marker with bracket</i>		2.43.068.00
	Fanale ingombro arancio senza staffa <i>Orange side marker without bracket</i>		2.43.070.00
	Trasparente <i>Lens</i>		2.43.068.24
	Segnalatore ingombro rosso / C. Cata <i>Red side marker</i>		2.43.182.00
	Trasparente rosso / C. Cata <i>Red lens</i>		2.43.182.21
	Segnalatore ingombro incolore / C. Cata <i>Clear side marker</i>		2.43.184.00
	Trasparente incolore <i>Clear lens</i>		2.43.184.25
* Ricambio di qualità equivalente <i>Matching quality spare parts</i>			

UNIVERSALE		6 LED 24V	
	Fanale ingombro incolore <i>Clear side marker</i>		2.43.116.80
	Segnalatore ingombro rosso <i>Red side marker</i>		2.43.118.80
	Segnalatore ingombro arancio <i>Orange side marker</i>		2.43.120.80
	dimensioni 220x340 mm.	* Ricambio di qualità equivalente <i>Matching quality spare parts</i>	

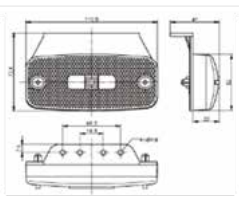
UNIVERSALE		LED 12 24V	
	Segnalatore ingombro arancio <i>Orange driver's side marker</i>		2.43.194.80
	dimensioni 110x72 mm. Con cavo 500 mm. <i>With 500 mm. cable</i>		* Ricambio di qualità equivalente <i>Matching quality spare parts</i>

UNIVERSALE		
	Segnalatore ingombro rosso/incolore <i>Red/clear side marker</i>	2.43.089.00
	Segnalatore ingombro rosso/incolore con staffa <i>Red/clear side markers with bracket</i>	2.43.088.00
	Trasparente rosso/incolore <i>Red/clear lens</i>	2.43.088.26
* Ricambio di qualità equivalente <i>Matching quality spare parts</i>		

UNIVERSALE	LED 12 24V	
	Segnalatore ingombro incolore con staffa <i>Clear driver's side marker with bracket</i>	2.43.196.80
	Segnalatore ingombro incolore <i>Clear driver's side marker</i>	2.43.197.80
	Segnalatore ingombro arancio con staffa <i>Orange driver's side marker with bracket</i>	2.43.198.80
	Segnalatore ingombro arancio <i>Orange driver's side marker</i>	2.43.199.80
	Segnalatore ingombro rosso con staffa <i>Red driver's side marker with bracket</i>	2.43.200.80
	Segnalatore ingombro rosso <i>Red driver's side marker</i>	2.43.201.80
dimensioni 120x45 mm. - Con cavo 500 mm. <i>With 500 mm. cable</i>		
* Ricambio di qualità equivalente <i>Matching quality spare parts</i>		

UNIVERSALE	FLATPOINT	LED 24V
	Fanale laterale bianco con cavo cm 50 e staffa <i>Side clear lamp with 50 cm cable and bracket</i>	→ 7.43.064.41 ←
	Fanale laterale con cavo cm 25 staffa e protezione <i>Side lamp with 25 cm cable bracket and protection</i>	→ 7.43.086.81 ←
	Fanale laterale con cavo cm 50 staffa e protezione <i>Side lamp with 50 cm cable bracket and protection</i>	→ 7.43.084.81 ←
	Fanale laterale con staffa e protezione 90° senza cavo <i>Side lamp with bracket and protection 90° without cable</i>	→ 7.43.080.81 ←

UNIVERSALE	UNIPOINT		LED 24V
	Fanale laterale con cavo cm 25 e staffa 90° <i>Side lamp with 25 cm cable and 90° bracket</i>	→	7.43.074.81
		←	
	Fanale laterale con cavo cm 25 e staffa verso catadiottro <i>Side lamp with 25 cm cable and bracket in direction of reflector</i>	→	7.43.078.81
		←	

UNIVERSALE		LED 12 24V
	Segnalatore ingombro incolore con staffa / <i>Clear driver's side marker with bracket</i>	2.43.158.80
	Segnalatore ingombro arancio / <i>Clear driver's side marker</i>	2.43.160.80
	Segnalatore ingombro incolore con staffa / <i>Orange driver's side marker with bracket</i>	2.43.162.80
	Segnalatore ingombro incolore / <i>Orange driver's side marker</i>	2.43.164.80
	Segnalatore ingombro rosso con staffa / <i>Red driver's side marker with bracket</i>	2.43.166.80
	Segnalatore ingombro rosso / <i>Red driver's side marker</i>	2.43.168.80
	dimensioni 95x30 mm. - Con cavo 60 mm. e rubacorrente <i>With 60 mm. cable and cable clamp</i>	
	* Ricambio di qualità equivalente Matching quality spare parts	

UNIVERSALE		LED 12 24V
	Segnalatore arancio con staffa / <i>Orange markers with bracket</i>	2.43.170.80
	Segnalatore incolore con staffa / <i>Clear markers with bracket</i>	2.43.174.80
	Segnalatore rosso con staffa / <i>Red markers with bracket</i>	2.43.178.80
	dimensioni 110x50 mm. - Con cavo 60 mm. e rubacorrente <i>With 60 mm. cable and cable clamp</i>	
* Ricambio di qualità equivalente Matching quality spare parts		

UNIVERSALE		LED 12 24V
	Segnalatore arancio / <i>Orange markers</i>	2.43.172.80
	Segnalatore incolore / <i>Clear markers</i>	2.43.176.80
	Segnalatore rosso / <i>Red markers</i>	2.43.180.80
	dimensioni 110x50 mm. - Con cavo 60 mm. e rubacorrente <i>With 60 mm. cable and cable clamp</i>	
* Ricambio di qualità equivalente Matching quality spare parts		

UNIVERSALE		LED 24V
	Segnalatore ingombro <i>Side marker</i>	2.43.122.80
	Segnalatore ingombro con staffa <i>Side marker with bracket</i>	2.43.124.80
	* Ricambio di qualità equivalente <i>Matching quality spare parts</i>	

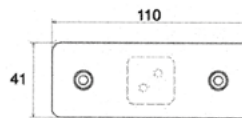

UNIVERSALE		LED 24V
	Segnalatore ingombro con staffa <i>Side marker with bracket</i>	2.43.054.81
	Segnalatore ingombro <i>Side marker</i>	2.43.052.81
	Segnalatore ingombro <i>Side marker</i>	2.43.056.81
* Ricambio di qualità equivalente <i>Matching quality spare parts</i>		

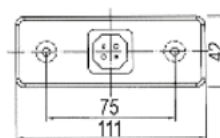

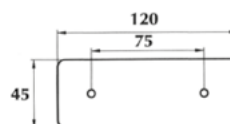

UNIVERSALE		1 LED 12 24V
	Fanale ingombro con catadiottero arancio con staffa <i>Side marker with orange reflector with bracket</i>	2.43.058.81
	Fanale ingombro con catadiottero arancio senza staffa <i>Side marker with orange reflector without bracket</i>	2.43.060.81
	* Ricambio di qualità equivalente <i>Matching quality spare parts</i>	



UNIVERSALE		LED 12 24V
	Segnalatore ingombro arancio 24V 24V orange side marker	2.43.048.80
	Segnalatore ingombro incolore 24V 24V clear side marker	2.43.040.80
	Segnalatore ingombro rosso 24V 24V red side marker	2.43.042.80
	12/24V cavo mm. 500 12/24V mm. 500 cable * Ricambio di qualità equivalente <i>Matching quality spare parts</i>	

UNIVERSALE		LED 24V
	Segnalatore ingombro rosso con catadiottro <i>Orange side marker with reflector</i>	2.43.272.80
	Segnalatore ingombro rosso <i>Red side marker</i>	2.43.274.80
	Segnalatore incolore <i>Clear side marker</i>	2.43.276.80
	* Ricambio di qualità equivalente <i>Matching quality spare parts</i>	



UNIVERSALE		LED 24V
	Segnalatore ingombro arancio - 2 serracavi <i>Orange clear side marker - 2 cable clamps</i>	2.43.289.80
	Segnalatore ingombro arancio - 2 passacavi <i>Orange side marker - 2 fairleads</i>	2.43.288.80
	Segnalatore ingombro arancio con staffa - 2 serracavi <i>Orange side marker with bracket - 2 cable clamps</i>	2.43.290.80
	Segnalatore ingombro arancio con staffa - 2 passacavi <i>Orange side marker with bracket - 2 fairleads</i>	2.43.291.80
	Segnalatore ingombro arancio con staffa - 2 serracavi <i>Orange side marker with bracket - 2 cable clamps</i>	2.43.292.80
	Segnalatore ingombro arancio con staffa - 2 passacavi <i>Orange side marker with bracket - 2 fairleads</i>	2.43.293.80
	* Ricambio di qualità equivalente <i>Matching quality spare parts</i>	

UNIVERSALE		LED 10 30V
	Sidemarker incolore rosso <i>Clear red side marker</i>	2.43.238.80
	Sidemarker arancio <i>Orange side marker</i>	2.43.240.80
	Sidemarker rosso <i>Red side marker</i>	2.43.242.80
	Sidemarker incolore <i>Clear side marker</i>	2.43.244.80
	Consumo <i>Consumption: 1,4W/1,4W per doppia funzione for double function</i> Consumo <i>Consumption: 0,7W/1,4W per singola funzione for single function</i>	
* Articolo universale <i>Universal part</i>		

UNIVERSALE		LED 12 24V
	Segnalatore ingombro incolore <i>Clear side marker</i>	2.43.254.80
	Segnalatore ingombro rosso <i>Red side marker</i>	2.43.255.80
	Fissaggio 2 viti 2 screws fixing Potenza assorbita Absorbed power: 0,4/0,8 W	
	* Articolo universale Universal part 	

UNIVERSALE		LED 24V
	Sidemarker arancio con catadiottro <i>Orange side marker with reflector</i>	2.43.256.80
	Sidemarker rosso con catadiottro <i>Red side marker with reflector</i>	2.43.257.80
	Sidemarker incolore con catadiottro <i>Clear side marker with reflector</i>	2.43.258.80
	mm. 100x38	* Articolo universale Universal part

UNIVERSALE		LED 12 24V
	Segnalatore ingombro rosso con cavo mm. 500 <i>Red side lamp with cable mm. 500</i>	2.43.195.80
	Segnalatore ingombro incolore con cavo mm. 500 <i>Clear side lamp with cable mm. 500</i>	2.43.195.81
	Consumo Consumption: 1,4W/1,4W per doppia funzione for double function Consumo Consumption: 0,7W/1,4W per singola funzione for single function	
	* Articolo universale Universal part	

UNIVERSALE		LED 12 24V
	Spia per sponde montacarichi <i>Lights for goods lift</i>	2.43.246.80
	Fissaggio 3 viti 3 screws fixing Potenza assorbita Absorbed power: 7 W	
	* Articolo universale Universal part 	

UNIVERSALE		3 LED 12 24V
	Fanale ingombro base piana rosso <i>Red side marker flat base</i>	2.43.096.80
	Fanale ingombro base piana incoloro <i>Clear side marker flat base</i>	2.43.094.80
	Fanale ingombro con staffa <i>Side marker with bracket</i>	2.43.092.80
	Fanale ingombro base piana <i>Side marker flat base</i>	2.43.090.80
	Con cavo 50 cm. <i>With wiring 50 cm.</i>	* Ricambio di qualità equivalente <i>Matching quality spare parts</i>

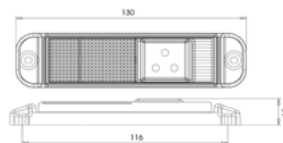

UNIVERSALE		LED 12 24V
	Segnalatore ingombro arancio 6 LED <i>6 LED orange side lamp</i>	1.43.082.80
	Segnalatore ingombro rosso 6 LED <i>6 LED red side lamp</i>	1.43.083.80
	Segnalatore ingombro incoloro 6 LED <i>6 LED clear side lamp</i>	1.43.084.80
	Segnalatore ingombro blu 6 LED <i>6 LED blue side lamp</i>	1.43.082.82
	Segnalatore ingombro verde 6 LED <i>6 LED green side lamp</i>	1.43.082.83
	* Articolo universale <i>Universal part</i> mm. 95x20	MADE IN ITALY BY OLSA



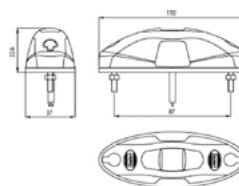

UNIVERSALE		LED 12 24V
	Segnalatore rosso <i>Red side marker</i>	2.43.208.80
	Segnalatore incoloro <i>Clear side marker</i>	2.43.210.80
	Segnalatore arancio <i>Orange side marker</i>	2.43.212.80
	81x29 mm.	* Ricambio di qualità equivalente <i>Matching quality spare parts</i>

UNIVERSALE		LED 10 30V
	Segnalatore rosso incoloro arancio con staffa <i>Red clear orange driver's side marker</i>	2.43.216.80
	Segnalatore rosso incoloro arancio <i>Red clear orange driver's side marker</i>	2.43.214.80
	81x29 mm.	* Ricambio di qualità equivalente <i>Matching quality spare parts</i>



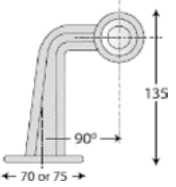

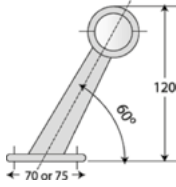

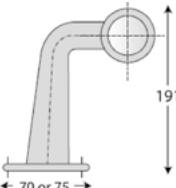







UNIVERSALE		LED 24V	
	Catadiottro arancio <i>Orange side marker</i>		2.43.134.80
	Catadiottro incolore <i>Clear side marker</i>		2.43.136.80
	Catadiottro rosso <i>Red side marker</i>		2.43.138.80
	101x52 mm.	* Ricambio di qualità equivalente Matching quality spare parts	

UNIVERSALE		LED 24V	
	Segnalatore rosso <i>Red side marker</i>		2.43.202.80
	Segnalatore incolore <i>Clear side marker</i>		2.43.204.80
	Segnalatore arancio <i>Orange side marker</i>		2.43.206.80
	250x424 mm.	* Ricambio di qualità equivalente Matching quality spare parts	

UNIVERSALE		LED 24V	
	Fanale ingombro braccio gomma rosso - incolore <i>Side marker with red - clear rubber arm</i>		2.43.128.81
	Fanale ingombro braccio gomma rosso - incolore <i>Side marker with red - clear rubber arm</i>		2.43.129.81
	Fanale ingombro braccio gomma rosso - incolore <i>Side marker with red - clear rubber arm</i>		2.43.078.81
	Fanale ingombro braccio gomma rosso - incolore <i>Side marker with red - clear rubber arm</i>		2.43.079.81
	Fanale ingombro braccio gomma rosso - incolore <i>Side marker with red - clear rubber arm</i>		2.43.076.81
	Fanale ingombro braccio gomma rosso - incolore <i>Side marker with red - clear rubber arm</i>		2.43.077.81
* Ricambio di qualità equivalente Matching quality spare parts			

* Per l'esatta classificazione della tipologia del ricambio, consultare pagina 3
For the exact identification of the category of the spare parts please see page 4

UNIVERSALE	SUPERPOINT III	LED 24V
	Fanale ingombro con cavo 125 cm <i>Side marker with 125 cm cable</i>	 7.43.070.80
	Fanale ingombro con cavo 125 cm <i>Side marker with 125 cm cable</i>	 7.43.071.80

UNIVERSALE	LED 24V	
	Segnalatore braccio in gomma rosso - incolore <i>Red - clear side rubber arm</i>	 2.43.186.80
	Segnalatore braccio in gomma rosso - incolore <i>Red - clear side rubber arm</i>	 2.43.187.80
	Segnalatore braccio in gomma rosso - incolore <i>Red - clear side rubber arm</i>	 2.43.188.80
	Segnalatore braccio in gomma rosso - incolore <i>Red - clear side rubber arm</i>	 2.43.189.80
	Segnalatore braccio in gomma rosso - incolore <i>Red - clear side rubber arm</i>	 2.43.190.80
	Segnalatore braccio in gomma rosso - incolore <i>Red - clear side rubber arm</i>	 2.43.191.80
	Segnalatore braccio in gomma rosso - incolore <i>Red - clear side rubber arm</i>	 2.43.192.80
	Segnalatore braccio in gomma rosso - incolore <i>Red - clear side rubber arm</i>	 2.43.193.80
	Gruppo ottico laterale con portalamпада <i>Side optical unit with bulb holder</i>	2.43.186.81
* Ricambio di qualità equivalente Matching quality spare parts		

UNIVERSALE		LED 24V
	Segnalatore braccio in gomma incolore - rosso - arancio <i>Clear - red - orange side rubber arm</i>	→ 2.43.150.80
	Segnalatore braccio in gomma incolore - rosso - arancio <i>Clear - red - orange side rubber arm</i>	← 2.43.151.80
	Segnalatore braccio in gomma incolore - rosso - arancio <i>Clear - red - orange side rubber arm</i>	→ 2.43.152.80
	Segnalatore braccio in gomma incolore - rosso - arancio <i>Clear - red - orange side rubber arm</i>	← 2.43.153.80
	Segnalatore braccio in gomma incolore - rosso - arancio <i>Clear - red - orange side rubber arm</i>	→ 2.43.154.80
	Segnalatore braccio in gomma incolore - rosso - arancio <i>Clear - red - orange side rubber arm</i>	← 2.43.155.80
Segnalatore braccio in gomma incolore - rosso - arancio <i>Clear - red - orange side rubber arm</i>	→ ← 2.43.156.80	
* Ricambio di qualità equivalente <i>Matching quality spare parts</i>		

UNIVERSALE		LED 24V
	Segnalatore ingombro <i>Side marker</i>	→ 2.43.102.81
		← 2.43.103.81
* Ricambio di qualità equivalente <i>Matching quality spare parts</i>		



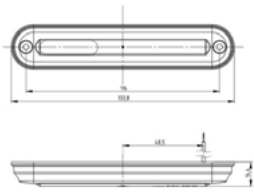

UNIVERSALE		LED 12 24V
	Fanale ingombro con cavo mm. 250 <i>Side marker with cable 250 mm.</i>	→ 2.43.234.80
	Fanale ingombro con cavo mm. 250 <i>Side marker with cable 250 mm.</i>	← 2.43.235.80
	Fanale ingombro con cavo mm. 250 <i>Side marker with cable 250 mm.</i>	→ 2.43.236.80
	Fanale ingombro con cavo mm. 250 <i>Side marker with cable 250 mm.</i>	← 2.43.237.80
	Fanale ingombro con cavo mm. 250 incolore - rosso - arancio <i>Side marker with cable 250 mm. clear red orange</i>	← 2.43.232.80
	* Articolo universale <i>Universal part</i>	

UNIVERSALE			3 LED 12 24V
	Fanale ingombro <i>Side marker</i>	→	2.43.086.81
	Fanale ingombro <i>Side marker</i>	←	2.43.087.81
	Trasparente rosso - incolore <i>Red - clear lens</i>		
* Ricambio di qualità equivalente <i>Matching quality spare parts</i>			





UNIVERSALE			3 LED 12 24V
	Fanale ingombro <i>Side marker</i>	→	2.43.084.81
	Fanale ingombro <i>Side marker</i>	←	2.43.085.81
	Trasparente rosso - incolore <i>Red - clear lens</i>		
* Ricambio di qualità equivalente <i>Matching quality spare parts</i>			

UNIVERSALE			LED 12 24V
	Fanale ingombro incolore <i>Clear side marker</i>		2.43.262.80
	Fanale ingombro arancio <i>Orange side marker</i>		2.43.263.80
	Fanale ingombro rosso <i>Red side marker</i>		2.43.264.80
* Ricambio di qualità equivalente <i>Matching quality spare parts</i>			

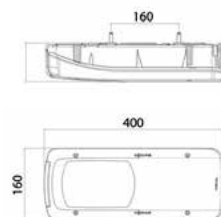



UNIVERSALE			
	Staffa <i>Bracket</i>	→	2.42.076.17
	Staffa <i>Bracket</i>	←	2.42.078.17
	* Articolo universale <i>Universal part</i>		



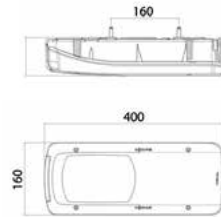

DAF	CF - XF	LC8
	Fanale posteriore <i>Rear lamp</i>	→ 5.44.090.00
	Fanale posteriore con cicalino <i>Rear lamp with buzzer</i>	→ 5.44.090.70
	Fanale posteriore con targa <i>Rear lamp with number plate</i>	← 5.44.091.01
	12→ Trasparente posteriore <i>Rear lens</i>	→ 5.44.090.20
	Trasparente posteriore <i>Rear lens</i>	→ 5.44.091.20
	Connettore <i>Connector</i>	3.49.096.00
	Attacco laterale HDSCS <i>Side connector HDSCS</i>	
		







DAF	CF - XF	LC8
	Fanale posteriore <i>Rear lamp</i>	→ 5.44.092.00
	Fanale posteriore con cicalino <i>Rear lamp with buzzer</i>	→ 5.44.092.70
	Fanale posteriore con targa <i>Rear lamp with number plate</i>	← 5.44.093.01
	12→ Trasparente posteriore <i>Rear lens</i>	→ 5.44.090.20
	Trasparente posteriore <i>Rear lens</i>	→ 5.44.091.20
	Connettore <i>Connector</i>	3.49.096.00
	Attacco posteriore HDSCS <i>Rear connector HDSCS</i>	
		



DAF	CF - XF	LC11 LED
	Fanale posteriore <i>Rear lamp</i>	 5.44.094.80
	Fanale posteriore <i>Rear lamp</i>	 5.44.095.80
	Trasparente posteriore <i>Rear lens</i>	 5.44.094.20
	Trasparente posteriore <i>Rear lens</i>	 5.44.095.20
	Connettore <i>Connector</i>	3.49.096.00
	Attacco laterale HDSCS <i>Side connector HDSCS</i>	

DAF	CF - XF	LC11 LED
	Fanale posteriore <i>Rear lamp</i>	 5.44.096.80
	Fanale posteriore <i>Rear lamp</i>	 5.44.097.80
	Trasparente posteriore <i>Rear lens</i>	 5.44.094.20
	Trasparente posteriore <i>Rear lens</i>	 5.44.095.20
	Connettore <i>Connector</i>	3.49.096.00
	Attacco posteriore HDSCS <i>Rear connector HDSCS</i>	

FIAT-OM	616N2-625N2-650-662	
	Fanale posteriore <i>Rear light</i>	 2.44.232.00 
	Trasparente posteriore <i>Rear lens</i>	 2.44.232.20 
* Ricambio di qualità equivalente <i>Matching quality spare parts</i>		

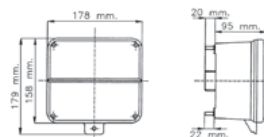

FIAT OM		LEONCINO DAINO	
	75→	Trasparente Lens	↔ ↔ 2.44.046.20
		* Ricambio di qualità equivalente Matching quality spare parts	

FIAT		DUCATO	
	84→94	Fanale posteriore Rear lamp	→ 2.44.110.00
			← 2.44.111.00
		* Ricambio di qualità equivalente Matching quality spare parts	

FIAT/CITROËN/PEUGEOT		DUCATO - JUMPER - BOXER	
	94→01	Fanale posteriore Rear lamp	→ 2.44.056.00
			← 2.44.057.00
		Gruppo ottico posteriore Rear optical unit	→ 2.44.056.10
			← 2.44.057.10
		Portalampane Bulb holder	2.44.056.18
* Ricambio di qualità equivalente Matching quality spare parts			

FIAT/CITROËN/PEUGEOT		DUCATO - JUMPER - BOXER	
	01→06	Fanale posteriore Rear lamp	→ 2.44.058.00
			← 2.44.059.00
		Gruppo ottico posteriore Rear optical unit	→ 2.44.058.10
			← 2.44.059.10
		* Ricambio di qualità equivalente Matching quality spare parts	

FIAT/CITROËN/PEUGEOT		DUCATO - JUMPER - BOXER	
	12→	Fanale posteriore <i>Rear lamp</i>	→ 5.44.124.00
			← 5.44.125.00
		Trasparente <i>Lens</i>	→ 5.44.098.20
			←
		4 perni - 4 pivots	

FIAT/CITROËN/PEUGEOT		DUCATO - JUMPER - BOXER	
	01→06	Fanale posteriore <i>Rear lamp</i>	→ 2.44.058.00
			← 2.44.059.00
		Gruppo ottico posteriore <i>Rear optical unit</i>	→ 2.44.058.10
			← 2.44.059.10
		* Ricambio di qualità equivalente <i>Matching quality spare parts</i>	

FIAT/CITROËN/PEUGEOT		DUCATO - JUMPER - BOXER	
	06	Fanale posteriore <i>Rear lamp</i>	→ 5.44.068.00
			← 5.44.069.00
		Gruppo ottico posteriore <i>Rear optical unit</i>	→ 2.44.206.10
			← 2.44.207.10
		Cablaggio per fanale posteriore ('07 - '11) <i>Rear lamp wiring ('07 - '11)</i>	→ 5.44.068.19
			← 5.44.069.19

FIAT		DUCATO MY 2014		
	14→	Gruppo ottico posteriore <i>Rear optical unit</i>	→ 2.44.272.10	
			← 2.44.273.10	
			* Ricambio di qualità equivalente <i>Matching quality spare parts</i>	
			Fanale posteriore <i>Rear lamp</i>	→ 5.44.088.00
		Fanale posteriore <i>Rear lamp</i>	← 5.44.089.00	

FIAT		DUCATO		
	94→01	Fanale posteriore <i>Rear lamp</i>	→	1.44.050.00
			←	1.44.051.00
		Trasparente <i>Lens</i>	→	1.44.050.20
			←	1.44.051.20
		Connettore <i>Connector</i>		6.49.052.00
		Cablaggio <i>Wiring</i>		3.49.082.00

FIAT		DUCATO		
	94→01	Fanale posteriore <i>Rear lamp</i>	→	2.44.228.00
			←	2.44.229.00
		Trasparente <i>Lens</i>	→	2.44.228.20
			←	2.44.229.20
		* Ricambio di qualità equivalente Matching quality spare parts		

FIAT		DUCATO		
	02→	Fanale posteriore <i>Rear lamp</i>	→	1.44.056.00
			←	1.44.057.00
		Trasparente posteriore <i>Rear lens</i>	→	1.44.050.20
			←	1.44.051.20
		Connettore <i>Connector</i>	1	3.49.058.00
			2	3.49.060.00

FIAT		DUCATO FURGONE		
	01→06	Fanale posteriore 3° stop <i>Rear lamp 3° stop</i>		1.44.096.00

FIAT		TALENTO	
	15→	Gruppo ottico posteriore <i>Rear optical unit</i>	→ 2.44.294.10
		Gruppo ottico posteriore <i>Rear optical unit</i>	← 2.44.295.10
		Fanale retromarcia <i>Reverse lamp</i>	→ 1.44.106.00
		Fanale retronebbia <i>Rear fog lamp</i>	← 1.44.107.00
		UK	
		<i>Rear fog lamp</i>	→ 1.44.104.00
	<i>Reverse lamp</i>	← 1.44.105.00	

FORD		CONNECT 2000	
	00→09	Gruppo ottico posteriore <i>Rear optical unit</i>	→ 2.44.054.10
			← 2.44.055.10
* Ricambio di qualità equivalente <i>Matching quality spare parts</i>			

FORD		CONNECT	
	09→	Fanale posteriore <i>Rear lamp</i>	→ 2.44.164.00
			← 2.44.165.00
* Ricambio di qualità equivalente <i>Matching quality spare parts</i>			

FORD		COURIER	
	14→	Gruppo ottico posteriore <i>Rear optical unit</i>	→ 2.44.264.10
			← 2.44.265.10
* Ricambio di qualità equivalente <i>Matching quality spare parts</i>			

FORD		TRANSIT MK V	
	95→01	Fanale posteriore <i>Rear lamp</i>	→ 2.44.048.00
			← 2.44.049.00
	* Ricambio di qualità equivalente Matching quality spare parts		
FORD		TRANSIT MK V	
	95→01	Gruppo ottico posteriore <i>Rear optical unit</i>	→ 2.44.050.10
			← 2.44.051.10
	* Ricambio di qualità equivalente Matching quality spare parts		
FORD		TRANSIT MK VII	
	06	Gruppo ottico posteriore <i>Rear optical unit</i>	→ 2.44.052.10
			← 2.44.053.10
	* Ricambio di qualità equivalente Matching quality spare parts		
FORD		TRANSIT PICK-UP	
	98→01	Fanale posteriore 1 luce con connettore e cavo 480 mm. <i>Rear lamp</i> 1 light with connector and 480 mm. cable	→ 2.44.070.00
			← 2.44.070.00
		Fanale posteriore 2 luce con connettore e cavo 480 mm. <i>Rear lamp</i> 2 light with connector and 480 mm. cable	→ 2.44.071.00
			← 2.44.071.00
		Fanale posteriore 2 luce con passacavo <i>Rear lamp</i> 2 light with fairlead	→ 2.44.040.00
		← 2.44.040.00	
		Trasparente posteriore <i>Rear lens</i>	→ 2.44.070.20
			← 2.44.070.20
* Ricambio di qualità equivalente Matching quality spare parts			

FORD		TRANSIT PICK-UP MK8	
	14→	Fanale posteriore <i>Rear lamp</i>	→ 2.44.278.00
		Fanale posteriore <i>Rear lamp</i>	← 2.44.279.00
		Trasparente posteriore <i>Rear lens</i>	→ 2.44.278.10
		Trasparente posteriore <i>Rear lens</i>	← 2.44.279.10
		* Ricambio di qualità equivalente <i>Matching quality spare parts</i>	

FORD		TRANSIT	
	14→	Gruppo ottico posteriore <i>Rear optical unit</i>	→ 2.44.266.10
		Gruppo ottico posteriore <i>Rear optical unit</i>	← 2.44.267.10
		* Ricambio di qualità equivalente <i>Matching quality spare parts</i>	

IVECO		CITELIS		LED	
	10→	Fanale posteriore stop posizione <i>Stop position rear lamp</i>			4.44.098.80
		Fanale posteriore retronebbia <i>Rear fog lamp</i>			4.44.100.80
		Fanale posteriore retromarcia <i>Reverse rear lamp</i>			4.44.102.80
		Fanale posteriore stop posizione direzione Rosso arancio <i>Stop position repeater rear lamp Red orange</i>			4.44.104.80
		* Ricambio di qualità equivalente <i>Matching quality spare parts</i>			

IVECO		DAILY 2000		LED	
	00→06	Fanale posteriore stop posizione <i>Stop position rear lamp</i>	→		2.44.060.00
		Fanale posteriore stop posizione <i>Stop position rear lamp</i>	←		2.44.061.00
		Gruppo ottico posteriore <i>Rear optical unit</i>	→		2.44.060.10
		Gruppo ottico posteriore <i>Rear optical unit</i>	←		2.44.061.10
		Terzo stop posteriore <i>Additional stop lamp</i>			1.44.098.00
* Ricambio di qualità equivalente <i>Matching quality spare parts</i>					

IVECO		DAILY	
	07→14	Fanale posteriore <i>Rear lamp</i>	→ 2.44.072.00
			← 2.44.073.00
		Gruppo ottico posteriore <i>Rear optical unit</i>	→ 2.44.072.10
			← 2.44.073.10

IVECO		DAILY 2014	
	14→	Fanale posteriore con retronebbia - retromarcia <i>Rear reverse - fog lamp</i>	→ 5.44.080.00
		Fanale posteriore con retronebbia - retromarcia <i>Rear reverse - fog lamp</i>	← 5.44.081.00
		Gruppo ottico posteriore <i>Rear optical unit</i>	→ 2.44.220.10
		Gruppo ottico posteriore <i>Rear optical unit</i>	← 2.44.221.10

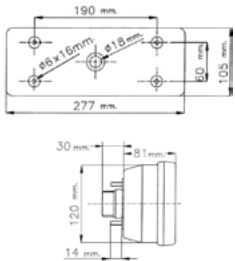

IVECO		DAILY	
	84→01	Fanale posteriore <i>Rear lamp</i>	→ 1.44.050.00
			← 1.44.051.00
		Trasparente posteriore <i>Rear lens</i>	→ 1.44.050.20
			← 1.44.051.20
		Connettore <i>Connector</i>	6.49.052.00
	Cablaggio <i>Wirings</i>	3.49.082.00	

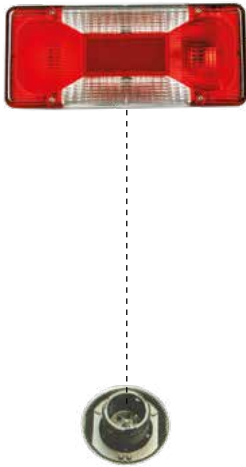
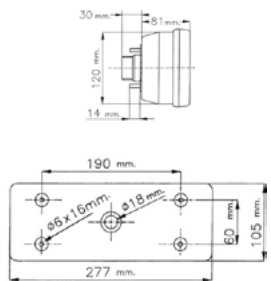
IVECO		DAILY S.		
	99→06	Fanale posteriore <i>Rear lamp</i>	→ 1.44.058.00	
			← 1.44.059.00	
		Trasparente posteriore <i>Rear lens</i>	→ 1.44.058.20	
			← 1.44.059.20	
		Funzioni <i>Functions</i>	5	
		Servizi <i>Services</i>	Direzione / Posizione / Stop / Retronebbia / Retromarcia / Catadiottro Repeater / Parking / Stop / Reversing lamp / Rear fog lamp / Reflector	
		Fissaggio <i>Fixing</i>	4 perni / 4 pivots	
Lampade <i>Bulbs</i>	3 x P21W - 2 x R5W			
	Connettore <i>Connector</i>	3.49.070.00		

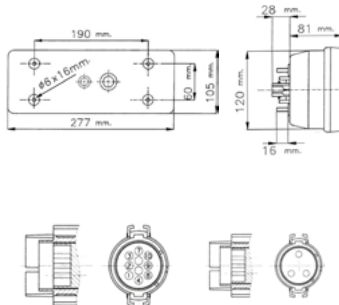
IVECO		DAILY S. 2000		
	06→	Fanale posteriore Rear lamp	→ 2.44.064.00 ← 2.44.065.00	
		Trasparente posteriore Rear lens	→ 2.44.064.20 ← 2.44.065.20	
		Funzioni Functions	5	
		Servizi Services	Direzione / Posizione / Stop / Retronebbia / Retromarcia / Catadiottro Repeater / Parking / Stop / Reversing lamp / Rear fog lamp / Reflector	
		Fissaggio Fixing	4 perni / 4 pivots	
		Lampade Bulbs	3 x P21W - 2 x R5W	
Connettore Connector		3.49.070.00		
* Ricambio di qualità equivalente Matching quality spare parts				

IVECO		EUROCARGO		
	→02	Fanale posteriore Rear lamp	→ 1.44.056.00 ← 1.44.057.00	
		Trasparente posteriore Rear lens	→ 1.44.050.20 ← 1.44.051.20	
		Funzioni Functions	5	
		Servizi Services	Direzione / Posizione / Stop / Retronebbia / Retromarcia / Catadiottro Repeater / Parking / Stop / Reversing lamp / Rear fog lamp / Reflector	
		Fissaggio Fixing	4 perni / 4 pivots	
		Lampade Bulbs	3 x P21W - 2 x R5W	
Connettore Connector		1 3.49.058.00 2 3.49.060.00		

IVECO		EUROCARGO	
	91→03	Trasparente posteriore Rear lens	→ 1.44.050.28 ← 1.44.051.29
		Circolazione sinistra Left hand traffic	

IVECO		EUROTECH			
		Fanale posteriore <i>Rear lamp</i>		➔	1.44.060.00
				➜	1.44.061.00
	93➔	Fanale posteriore con targa <i>Rear lamp with number plate</i>		➔	1.44.063.01
		Trasparente posteriore <i>Rear lens</i>		➔	1.44.052.20
				➜	1.44.053.20
		Funzioni <i>Functions</i>	6		
		Servizi <i>Services</i>	Direzione / Posizione / Stop / Retronebbia / Retromarcia / Catadiottro <i>Repeater / Parking / Stop / Reversing lamp / Rear fog lamp / Reflector</i>		
		Fissaggio <i>Fixing</i>	4 perni / 4 pivots		
		Lampade <i>Bulbs</i>	5 x P21W - 2 x R5W		
		Connettore <i>Connector</i>		1	3.49.058.00
				2	3.49.060.00

IVECO		EUROCARGO			
	11➔	Fanale posteriore <i>Rear lamp</i>		➔	5.44.098.00
				➜	5.44.099.00
		Fanale posteriore con cicalino <i>Rear lamp with buzzer</i>		➔	5.44.098.70
		Fanale posteriore con targa <i>Rear lamp with number plate</i>		➜	5.44.099.01
		Trasparente posteriore <i>Rear lens</i>		➔	5.44.098.20
				➜	
		Funzioni <i>Functions</i>	6 pin		
		Servizi <i>Services</i>	Direzione/Posizione/Stop/Retronebbia Retromarcia/Catadiottro <i>Repeater/Parking/Stop/Reversing lamp/Rear fog lamp/Reflector</i>		
		Fissaggio <i>Fixing</i>	2 perni / 2 pivots con cavo		
		Lampade <i>Bulbs</i>	4 x P21W - 3 x R5W		
		Connettore <i>Connector</i>			3.49.070.00





IVECO		EUROCARGO STRALIS		LED
	96→	Fanale posteriore <i>Rear lamp</i>	→	1.44.064.00
			←	1.44.065.00
		Fanale posteriore con targa <i>Rear lamp with number plate</i>	→	1.44.066.01
			→	1.44.067.01
		Trasparente posteriore <i>Rear lens</i>	→	1.44.064.21
			←	
		Fanale posteriore senza catadiottro <i>Rear Lens without reflex reflector</i>		1.44.070.22
		Funzioni <i>Functions</i>	7	
Servizi <i>Services</i>	Direzione / Posizione / Stop / Retronebbia / Retromarcia / Catadiottro <i>Repeater / Parking / Stop / Reversing lamp / Rear fog lamp / Reflector</i>			
Fissaggio <i>Fixing</i>	4 perni / 4 pivots			
Connettore Connector		3.49.058.00		



IVECO		EUROCARGO - STRALIS			
	96→	Fanale posteriore <i>Rear lamp</i>	→	2.44.138.00	
		Fanale posteriore 7 funzioni con targa <i>Rear lamp 7 functions with number plate light</i>	←	2.44.139.01	
		Trasparente <i>Lens</i>	→	1.44.064.21	
			←		
		Funzioni <i>Functions</i>	7		
		Servizi <i>Services</i>	Direzione / Posizione / Stop / Retronebbia / Retromarcia / Catadiottro <i>Repeater / Parking / Stop / Reversing lamp / Rear fog lamp / Reflector</i>		
Fissaggio <i>Fixing</i>	4 perni / 4 pivots				
* Ricambio di qualità equivalente Matching quality spare parts					

IVECO		EUROCARGO - STRALIS	
	14→	Terzo stop base <i>Additional stop light (base)</i>	5.44.084.00
		Terzo stop medio <i>Additional stop light (middle)</i>	5.44.086.00

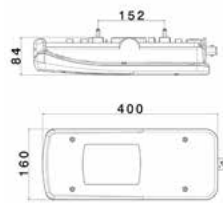

IVECO	EUROCARGO - STRALIS EURO 6		
	Fanale posteriore 7 funzioni <i>Rear lamp 7 functions</i>	→	1.44.100.00
	Fanale posteriore 7 funzioni <i>Rear lamp 7 functions</i>	→	1.44.101.00
	Fanale posteriore 7 funzioni / <i>Rear lamp 7 functions</i> Con cicalino / <i>with beeper</i>	←	1.44.102.70
	Fanale posteriore 7 funzioni / <i>Rear lamp 7 functions</i> Con luce targa / <i>with number plate light</i>	→	1.44.103.01
	12→ Trasparente posteriore <i>Rear lens</i>	→	1.44.064.21
	Funzioni <i>Functions</i> 7		
	Servizi <i>Services</i> Direzione / Posizione / Stop / Retronebbia / Retromarcia / Catadiottro <i>Repeater / Parking / Stop / Reversing lamp / Rear fog lamp / Reflector</i>		
	Fissaggio <i>Fixing</i> 4 perni / 4 pivots		
Connettore per 7 funzioni <i>Connector 7 functions</i>			3.49.090.00

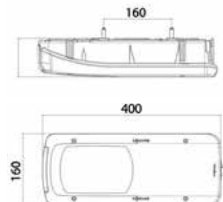



IVECO	STRALIS		LC11 LED
	Fanale posteriore <i>Rear lamp</i>	→	5.44.100.80
	Fanale posteriore <i>Rear lamp</i>	→	5.44.100.78
	Fanale posteriore / <i>Rear lamp</i> Con cicalino / <i>with beeper</i>	←	5.44.101.80
	Fanale posteriore / <i>Rear lamp</i> Con luce targa / <i>with number plate light</i>	→	5.44.101.81
	16→ Trasparente posteriore <i>Rear lens</i>	→	5.44.100.20
		←	5.44.101.20
	Funzioni <i>Functions</i> 7		
	Servizi <i>Services</i> Direzione / Posizione / Stop / Retronebbia / Retromarcia / Catadiottro <i>Repeater / Parking / Stop / Reversing lamp / Rear fog lamp / Reflector</i>		
Fissaggio <i>Fixing</i> 2 perni / 2 pivots			
Connettore <i>Connector</i>			3.49.096.00
Attacco laterale HDSCS <i>Side connector HDSCS</i>			



IVECO	STRALIS TRAKKER		LC11 LED	
	Fanale posteriore 7 funzioni <i>Rear lamp 7 functions</i>	→	5.44.102.80	
	Fanale posteriore 7 funzioni / <i>Rear lamp 7 functions</i> Con cicalino / <i>with beeper</i>	←	5.44.103.80	
	Fanale posteriore 7 funzioni <i>Rear lamp 7 functions</i>	→	5.44.102.78	
	Fanale posteriore 7 funzioni / <i>Rear lamp 7 functions</i> Con luce targa / <i>with number plate light</i>	→	5.44.103.81	
	16→	Trasparente posteriore <i>Rear lens</i>	→	5.44.100.20
		Trasparente posteriore <i>Rear lens</i>	←	5.44.101.20
	Funzioni <i>Functions</i>	7		
	Servizi <i>Services</i>	Direzione / Posizione / Stop / Retronebbia / Retromarcia / Catadiottro <i>Repeater / Parking / Stop / Reversing lamp / Rear fog lamp / Reflector</i>		
	Fissaggio <i>Fixing</i>	2 perni / <i>2 pivots</i>		
		Connettore <i>Connector</i>		3.49.096.00
	Attacco posteriore HDSCS <i>Rear connector HDSCS</i>			

IVECO	STRALIS TRAKKER		LC8	
	Fanale posteriore <i>Rear lamp</i>	→	5.44.104.00	
	Fanale posteriore con cicalino <i>Rear lamp with buzzer</i>	→	5.44.104.70	
	Fanale posteriore con targa <i>Rear lamp with number plate</i>	←	5.44.105.01	
	Trasparente posteriore <i>Rear lens</i>	→	5.44.104.20	
	16→	Trasparente posteriore <i>Rear lens</i>	←	5.44.105.20
		Funzioni <i>Functions</i>	7	
	Servizi <i>Services</i>	Direzione / Posizione / Stop / Retronebbia / Retromarcia / Catadiottro <i>Repeater / Parking / Stop / Reversing lamp / Rear fog lamp / Reflector</i>		
	Fissaggio <i>Fixing</i>	2 perni / <i>2 pivots</i>		
		Connettore <i>Connector</i>		3.49.096.00
		Attacco laterale HDSCS <i>Side connector HDSCS</i>		

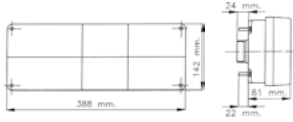
IVECO	STRALIS TRAKKER EURO 6		LC8 FUMĚ
	Fanale posteriore <i>Rear lamp</i>	→	5.44.106.00
	Fanale posteriore con cicalino <i>Rear lamp with buzzer</i>	→	5.44.106.70
	Fanale posteriore <i>Rear lamp</i>	←	5.44.107.00
	Fanale posteriore con targa <i>Rear lamp with number plate</i>	→	5.44.107.01
	Trasparente posteriore <i>Rear lens</i>	→	5.44.104.20
		←	5.44.105.20
	Funzioni <i>Functions</i>	7	
	Servizi <i>Services</i>	Direzione / Posizione / Stop / Retronebbia / Retromarcia / Catadiottro <i>Repeater / Parking / Stop / Reversing lamp / Rear fog lamp / Reflector</i>	
	Fissaggio <i>Fixing</i>	2 perni / 2 pivots	
	Connettore Connector		
Attacco posteriore HDSCS <i>Rear connector HDSCS</i>			

IVECO	STRALIS TRAKKER		LCS
	Fanale posteriore <i>Rear lamp</i>	→	5.44.098.00
	Fanale posteriore <i>Rear lamp</i>	←	5.44.099.00
	Fanale posteriore con cicalino <i>Rear lamp with buzzer</i>	→	5.44.098.70
	Fanale posteriore con targa <i>Rear lamp with number plate</i>	←	5.44.099.01
	Trasparente posteriore <i>Rear lens</i>	→	5.44.098.20
		←	
Funzioni <i>Functions</i>	6 pin		
Servizi <i>Services</i>	Direzione/Posizione/Stop/Retronebbia Retromarcia/Catadiottro <i>Repeater/Parking/Stop/Reversing lamp/Rear fog lamp/Reflector</i>		
Fissaggio <i>Fixing</i>	2 perni / 2 pivots con cavo		
Lampade <i>Bulbs</i>	4 x P21W - 3 x R5W		
Connettore Connector			3.49.070.00
			

IVECO		TURBOSTAR				
 	83→	Fanale posteriore <i>Rear lamp</i>		→	1.44.052.00	
				←	1.44.053.00	
		Con luce targa <i>With number plate light</i>			1.44.055.01	
		Trasparente posteriore <i>Rear lens</i>		→	1.44.052.20	
				←	1.44.053.20	
		Funzioni <i>Functions</i>	6	 		
		Servizi <i>Services</i>	Direzione / Posizione / Stop / Retronebbia / Retromarcia / Catadiottro <i>Repeater / Parking / Stop / Reversing lamp / Rear fog lamp / Reflector</i>			
		Fissaggio <i>Fixing</i>	4 perni / 4 pivots			
		Lampade <i>Bulbs</i>	5 x P21W - 2 x R5W			
		Connettore <i>Connector</i>			3.49.058.00	
			3.49.060.00			

KRONE		RIMORCHI TRAILERS				
 	11→	Fanale posteriore con catadiottro triangolare <i>Rear light with triangular reflex-reflector</i>		→	2.44.216.00	
				←	2.44.217.00	
		Trasparente con catadiottro triangolare <i>Lens with triangular reflector</i>		→	2.44.216.20	
				←	2.44.217.20	
		Funzioni / <i>Functions</i>	7			
		Fissaggio / <i>Fixing</i>	2 perni / 2 pivots			
* Ricambio di qualità equivalente <i>Matching quality spare parts</i>						

KRONE		RIMORCHI TRAILERS				
 	11→	Fanale posteriore con catadiottro triangolare <i>Rear light with triangular reflector</i>		→	2.44.218.00	
				←	2.44.219.00	
		trasparente con catadiottro triangolare <i>Lens with triangular reflector</i>		→	2.44.216.20	
				←	2.44.217.20	
		Funzioni / <i>Functions</i>	7			
		Fissaggio / <i>Fixing</i>	2 perni / 2 pivots			
* Ricambio di qualità equivalente <i>Matching quality spare parts</i>						

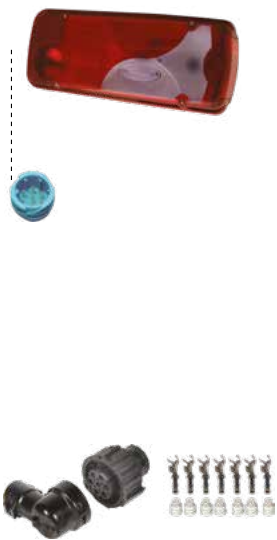
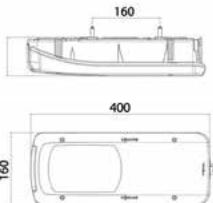
MAN-DAF		TGA - TGL - TGM		
	96→	Fanale posteriore <i>Rear lamp</i>	→ 5.44.060.00	
		Con luce targa <i>With number plate light</i>	← 5.44.061.00	
		Trasparente posteriore <i>Rear lens</i>	→ 5.44.060.20	
			← 5.44.061.20	
		Funzioni <i>Functions</i>	7	
		Servizi <i>Services</i>	Direzione / Posizione / Stop / Retronebbia / Retromarcia / Ingombro arancio <i>Repeater / Parking / Stop / Reversing lamp / Rear fog lamp / Side marker</i>	
		Fissaggio <i>Fixing</i>	2 perni / 2 pivots	
		Lampade <i>Bulbs</i>	5 x P21W - 2 x R5W	
	Connettore <i>Connector</i>		3.49.070.00	



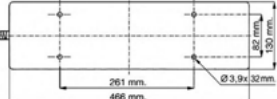

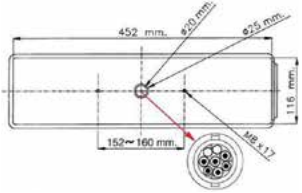

MAN-DAF		F 2000		
	06→11	Fanale posteriore <i>Rear lamp</i>	→ 2.44.176.00	
			← 2.44.177.01	
		Trasparente posteriore <i>Rear lens</i>	→ 2.44.174.20	
		Funzioni <i>Functions</i>	7 - 6 Pin attacco laterale <i>7 - 6 Pin side fitting</i>	
		Servizi <i>Services</i>	Direzione / Posizione / Stop / Retronebbia / Retromarcia / Ingombro arancio <i>Repeater / Parking / Stop / Reversing lamp / Rear fog lamp / Side marker</i>	
Fissaggio <i>Fixing</i>	2 perni / 2 pivots			
Lampade <i>Bulbs</i>	4 x P21W - 3 x R5W			

MAN-DAF		F 2000	
	06→11	Fanale posteriore <i>Rear lamp</i>	→ 4.44.084.01
			← 4.44.085.01
		Trasparente posteriore <i>Rear lens</i>	→ 4.44.084.20
			← 4.44.084.20
		Funzioni <i>Functions</i>	7 - 6 Pin attacco laterale <i>7 - 6 Pin side fitting</i>
Servizi <i>Services</i>	Direzione / Posizione / Stop / Retronebbia / Retromarcia / Ingombro arancio <i>Repeater / Parking / Stop / Reversing lamp / Rear fog lamp / Side marker</i>		
Fissaggio <i>Fixing</i>	2 perni / 2 pivots		
Lampade <i>Bulbs</i>	4 x P21W - 3 x R5W		

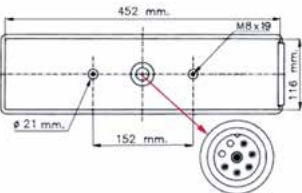

MAN-DAF		F 2000		
	06→11	Fanale posteriore <i>Rear lamp</i>	→ 2.44.120.00	
			← 2.44.121.00	
		Con luce targa <i>With number plate light</i>	2.44.123.01	
		Trasparente posteriore <i>Rear lens</i>	→ 2.44.174.20	
			←	
		Funzioni <i>Functions</i>	7 - 6 Pin attacco centrale <i>7 - 6 Pin central fitting</i>	
		Servizi <i>Services</i>	Direzione / Posizione / Stop / Retronebbia / Retromarcia / Ingombro arancio <i>Repeater / Parking / Stop / Reversing lamp / Rear fog lamp / Side marker</i>	
		Fissaggio <i>Fixing</i>	2 perni / 2 pivots	
		Lampade <i>Bulbs</i>	4 x P21W - 3 x R5W	
		Connettore <i>Connector</i>		3.49.090.00
* Ricambio di qualità equivalente <i>Matching quality spare parts</i>				

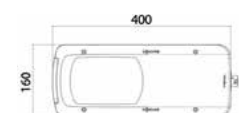
MAN / DAF		FM-FL		
		Fanale posteriore <i>Rear lamp</i>	→ 4.44.070.00	
			← 4.44.071.00	
		Con luce targa <i>With number plate light</i>	4.44.071.01	
		Trasparente posteriore <i>Rear lens</i>	→ 2.44.174.20	
			←	
		Funzioni <i>Functions</i>	7 - 6 Pin attacco centrale <i>7 - 6 Pin central fitting</i>	
		Servizi <i>Services</i>	Direzione / Posizione / Stop / Retronebbia / Retromarcia / Catadiottro <i>Repeater / Parking / Stop / Reversing lamp / Rear fog lamp / Reflector</i>	
		Fissaggio <i>Fixing</i>	2 perni / 2 pivots	
		Lampade <i>Bulbs</i>	4 x P21W - 3 x R5W	
		Connettore <i>Connector</i>		3.49.070.00
				

MAN	TGE	LC8
	Fanale posteriore <i>Rear lamp</i>	➔ 5.44.116.00
	Fanale posteriore <i>Rear lamp</i>	➜ 5.44.117.00
	Trasparente posteriore <i>Rear lens</i>	➜ 5.44.060.20
	Trasparente posteriore <i>Rear lens</i>	➔ 5.44.061.20
	Connettore Connector	➜ 3.49.070.00
	Funzioni / <i>Functions</i>	
	Servizi / <i>Services</i>	
	Fissaggio / <i>Fixing</i>	
	Lampade / <i>Bulbs</i>	
Attacco posteriore AMP 1.5 <i>Rear connector AMP 1.5</i>		
		

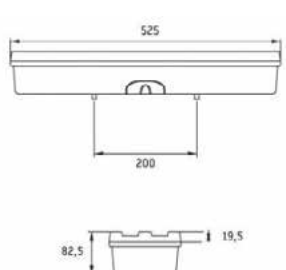
MERCEDES	ACTROS		
	Fanale posteriore <i>Rear lamp</i>	➔ 2.44.078.00	
	Fanale posteriore <i>Rear lamp</i>	➜ 2.44.079.00	
	Con luce targa <i>With number plate light</i>	2.44.081.01	
	Trasparente posteriore <i>Rear lens</i>	➔ 2.44.078.20	
	Trasparente posteriore <i>Rear lens</i>	➜ 2.44.079.20	
	Funzioni <i>Functions</i>	7 - 6 Pin attacco laterale <i>7 - 6 Pin side fitting</i>	
	Servizi <i>Services</i>	Direzione / Posizione / Stop / Retronebbia / Retromarcia / Catadiottro <i>Repeater / Parking / Stop / Reversing lamp / Rear fog lamp / Reflector</i>	
	Fissaggio <i>Fixing</i>	2 perni / <i>2 pivots</i>	
	Lampade <i>Bulbs</i>	4 x P21W - 3 x R5W	
Connettore <i>Connector</i>		3.49.070.00	
* Ricambio di qualità equivalente <i>Matching quality spare parts</i>			

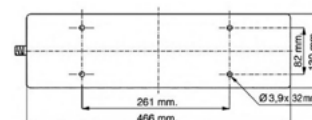

MERCEDES	ACTROS MP IV	
	Fanale posteriore <i>Rear lamp</i>	➔ 2.44.276.00
	Fanale posteriore con cicalino <i>Rear lamp with buzzer</i>	➔ 2.44.276.70
	Fanale posteriore con targa <i>Rear lamp with number plate</i>	➜ 2.44.277.01
	Trasparente posteriore <i>Rear lens</i>	➔ 2.44.276.10
	Trasparente posteriore <i>Rear lens</i>	➜ 2.44.276.10
* Ricambio di qualità equivalente <i>Matching quality spare parts</i>		

MERCEDES		ATEGO	
	99→04	Fanale posteriore <i>Rear lamp</i>	➔ 2.44.184.00
		Con luce targa <i>With number plate light</i>	➤ 2.44.081.01
		Trasparente posteriore <i>Rear lens</i>	➔ 2.44.182.20
		Funzioni <i>Functions</i>	7 - 6 Pin attacco centrale <i>7 - 6 Pin central fitting</i>
		Servizi <i>Services</i>	Direzione / Posizione / Stop / Retronebbia / Retromarcia / Catadiottro <i>Repeater / Parking / Stop / Reversing lamp</i> <i>/ Rear fog lamp / Reflector</i>
		Fissaggio <i>Fixing</i>	2 perni / 2 pivots
		Lampade <i>Bulbs</i>	4 x P21W - 3 x R5W
Connettore <i>Connector</i>		3.49.090.00	





MERCEDES		EVOBUS	
 		Fanale posteriore posizione stop <i>Rear lamp parking stop</i>	➔ 4.44.092.00
			➤ 4.44.093.00
		Fanale posteriore direzione arancio <i>Orange rear lamp repeater</i>	➔ 4.44.094.00
			➤ 4.44.095.00
		Fanale posteriore retronebbia <i>Rear fog lamp</i>	➔ 4.44.096.00
			➤ 4.44.097.00

MERCEDES		SPRINTER	
	95→02	Gruppo ottico posteriore <i>Rear optical unit</i>	➔ 2.44.108.10
			➤ 2.44.109.10
* Ricambio di qualità equivalente <i>Matching quality spare parts</i>			

MERCEDES		SPRINTER	
 	02→05	Fanale posteriore <i>Rear lamp</i>	➔ 2.44.062.00
			➤ 2.44.063.00
		Gruppo ottico posteriore <i>Rear optical unit</i>	➔ 2.44.062.10
			➤ 2.44.063.10
		Portalampade <i>Bulb holder</i>	2.44.062.18
* Ricambio di qualità equivalente <i>Matching quality spare parts</i>			

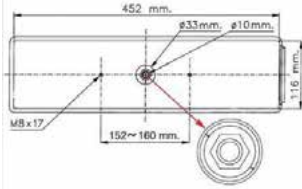
MERCEDES		SPRINTER	
	06	Fanale posteriore <i>Rear lamp</i>	→ 5.44.076.00
			← 5.44.077.00
		Gruppo ottico posteriore <i>Rear optical unit</i>	→ 2.44.076.10
			← 2.44.077.10

MERCEDES		SPRINTER		
	95→02	Fanale posteriore <i>Rear lamp</i>	→ 2.44.182.00	
		Fanale posteriore con luce targa <i>Rear lamp With number plate light</i>	← 2.44.183.01	
		Trasparente posteriore <i>Rear lens</i>	→ 2.44.182.20	
			←	
		Funzioni <i>Functions</i>	7 - Con passacavo / <i>With fairlead</i>	
		Servizi <i>Services</i>	Direzione / Posizione / Stop / Retronebbia / Retromarcia / Ingombro arancio <i>Repeater / Parking / Stop / Reversing lamp / Rear fog lamp / Side marker</i>	
Fissaggio <i>Fixing</i>	2 perni / <i>2 pivots</i>			
Lampade <i>Bulbs</i>	4 x P21W - 3 x R5W			
Con passacavo <i>With fairlead</i> * Ricambio di qualità equivalente Matching quality spare parts				

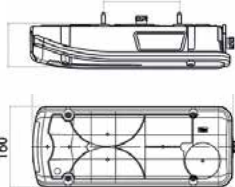

MERCEDES		SPRINTER		
	06→	Fanale posteriore <i>Rear lamp</i>	→ 5.44.070.00	
		Fanale posteriore con luce targa <i>Rear lamp With number plate light</i>	→ 5.44.071.01	
			←	
		Trasparente posteriore <i>Rear lens</i>	→ 5.44.070.20	
			← 5.44.071.20	
		Funzioni <i>Functions</i>	7	
		Servizi <i>Services</i>	Direzione / Posizione / Stop / Retronebbia / Retromarcia / Ingombro arancio <i>Repeater / Parking / Stop / Reversing lamp / Rear fog lamp / Side marker</i>	
		Fissaggio <i>Fixing</i>	2 perni / <i>2 pivots</i>	
Lampade <i>Bulbs</i>	4 x P21W - 3 x R5W			
Connettore <i>Connector</i>			3.49.070.00	
Con passacavo <i>With fairlead</i> * Ricambio di qualità equivalente Matching quality spare parts				

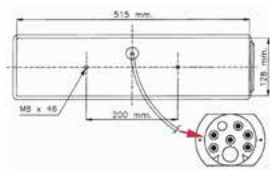
* Per l'esatta classificazione della tipologia del ricambio, consultare pagina 3
For the exact identification of the category of the spare parts please see page 4

MERCEDES		SK		
 <p>Con cavo m 1,50</p>	Fanale posteriore <i>Rear lamp</i>	➔	2.44.172.00	
	Fanale posteriore con targa <i>Rear lamp with number plate light</i>	➜	2.44.173.01	
	Fanale posteriore trasparente <i>Rear Lens</i>	➔	2.44.078.20	
		➜	2.44.079.20	
	Funzioni <i>Functions</i>	7		
	Servizi <i>Services</i>	Direzione / Posizione / Stop / Retronebbia / Retromarcia / Catadiottro <i>Repeater / Parking / Stop / Reversing lamp Rear fog lamp / Reflector</i>		
	Fissaggio <i>Fixing</i>	2 perni / 2 pivots		
Lampade <i>Bulbs</i>	4 x P21W - 3 x R5W			
				
* Ricambio di qualità equivalente Matching quality spare parts				

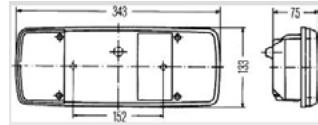
MERCEDES		II SERIE	
	Fanale posteriore <i>Rear lamp</i>	➔	2.44.118.00
	Fanale posteriore con luce targa <i>Rear lamp with number plate light</i>	➜	2.44.119.01
	Trasparente posteriore <i>Rear lens</i>	➔	2.44.118.20
		➜	2.44.118.20
* Ricambio di qualità equivalente Matching quality spare parts			

MERCEDES-MAN		VARIOUS		
	Fanale posteriore <i>Rear lamp</i>	➔	2.44.124.00	
		➜	2.44.125.00	
	Fanale posteriore con luce targa <i>Rear lamp with number plate light</i>	➜	2.44.127.01	
	Trasparente posteriore <i>Rear lens</i>	➔	2.44.124.20	
		➜	2.44.124.20	
	Funzioni <i>Functions</i>	6 - Con passacavo / <i>With fairlead</i>		
	Servizi <i>Services</i>	Direzione / Posizione / Stop / Retronebbia / Retromarcia / Catadiottro <i>Repeater / Parking / Stop / Reversing lamp Rear fog lamp / Reflector</i>		
Fissaggio <i>Fixing</i>	2 perni / 2 pivots			
Lampade <i>Bulbs</i>	4 x P21W - 3 x R5W			
				
* Ricambio di qualità equivalente Matching quality spare parts				

MERCEDES-MAN		VARIOUS	
		Fanale posteriore senza catadiottro <i>Rear lamp without reflector</i>	➔ 2.44.284.00
			➜ 2.44.285.00
		Fanale posteriore con luce targa senza catadiottro <i>Rear lamp with number plate light without reflector</i>	➔ 2.44.286.01
			➜ 2.44.287.01
		Trasparente posteriore senza catadiottro <i>Rear lens without reflector</i>	➔ 2.44.284.21
		Funzioni <i>Functions</i>	6 - Con passacavo / <i>With fairlead</i>
		Servizi <i>Services</i>	Direzione / Posizione / Stop / Retronebbia / Retromarcia / Catadiottro <i>Repeater / Parking / Stop / Reversing lamp / Rear fog lamp / Reflector</i>
		Fissaggio <i>Fixing</i>	2 perni / 2 pivots
		Lampade <i>Bulbs</i>	4 x P21W - 3 x R5W
* Ricambio di qualità equivalente Matching quality spare parts			

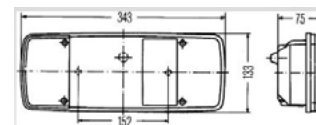



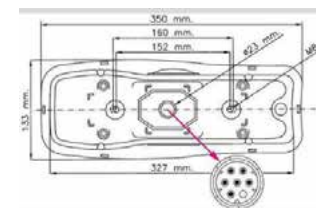



NISSAN-RENAULT		CABSTAR - MASCOTT - MIDLUM	
	05→	Fanale posteriore <i>Rear lamp</i>	➔ 5.44.122.00
			➜ 5.44.123.00
		Fanale posteriore con luce targa <i>Rear lamp with number plate light</i>	➜ 5.44.123.00
		Trasparente <i>Lens</i>	5.44.098.20
		Funzioni <i>Functions</i>	6 pin
		Servizi <i>Services</i>	Direzione / Posizione / Stop / Retronebbia / Retromarcia / Catadiottro <i>Repeater / Parking / Stop / Reversing lamp / Rear fog lamp / Reflector</i>
		Fissaggio <i>Fixing</i>	2 perni / 2 pivots con cavo
		Lampade <i>Bulbs</i>	4 x P21W - 3 x R5W
		Connettore <i>Connector</i>	3.49.070.00
* Ricambio di qualità equivalente Matching quality spare parts			

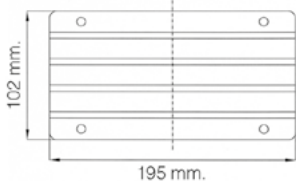



OPEL-RENAULT		MOVANO - MASTER	
	04→	Fanale posteriore <i>Rear lamp</i>	➔ 5.44.058.00
			➜ 5.44.059.00
		3° Stop posteriore <i>Additional stop lamp</i>	1.44.094.00

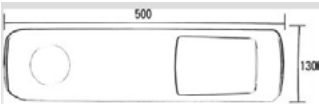

OPEL		MOVANO	
	10→	Gruppo ottico posteriore <i>Rear optical unit</i>	→ 2.44.260.10
		Gruppo ottico posteriore <i>Rear optical unit</i>	← 2.44.261.10
	* Ricambio di qualità equivalente <i>Matching quality spare parts</i>		

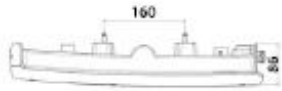
PIAGGIO		APE H		
	10→	Fanale posteriore <i>Rear lamp</i>	→ 1.44.074.00	
		Con luce targa <i>With number plate light</i>	← 1.44.075.01	
		Trasparente <i>Lens</i>	→ 1.44.074.20	
		Trasparente con luce targa <i>Lens with number plate light</i>	← 1.44.075.21	
		Funzioni <i>Functions</i>	4	
		Servizi <i>Services</i>	Direzione / Posizione / Stop / Catadiottero <i>Repeater / Parking / Stop /</i>	
	Fissaggio <i>Fixing</i>	2 perni / 2 pivots		
Lampade <i>Bulbs</i>	1 x P21W - 1 x P21 5W			
* Ricambio di qualità equivalente <i>Matching quality spare parts</i>				

RENAULT		PREMIUM - KERAX - MAGNUM		
   	06→	Fanale posteriore <i>Rear lamp</i>	→ 5.44.066.00	
		Con luce targa <i>With number plate light</i>	← 5.44.067.00	
		Trasparente posteriore <i>Rear Lens</i>	→ 5.44.066.20	
		Funzioni <i>Functions</i>	7	
		Servizi <i>Services</i>	Direzione / Posizione / Stop / Retronebbia / Retromarcia / Ingombro rosso <i>Repeater / Parking / Stop / Reversing lamp / Rear fog lamp / Side marker red / Reflector</i>	
		Fissaggio <i>Fixing</i>	2 perni / 2 pivots	
	Lampade <i>Bulbs</i>	4 x P21W - 3 x R5W		
Connettore <i>Connector</i>		3.49.070.00		
				

RENAULT		EURO 6 T-K-C-D		LC9 LED	
	16→	Fanale posteriore <i>Rear lamp</i>	→	5.44.108.80	
		Fanale posteriore con cicalino <i>Rear lamp with buzzer</i>	→	5.44.108.81	
		Fanale posteriore <i>Rear lamp</i>	←	5.44.109.80	
		Trasparente posteriore <i>Rear lens</i>	→ ←	5.44.108.20	
		Funzioni <i>Functions</i>	7 pin		
		Servizi <i>Services</i>	Direzione / Posizione / Stop / Retronebbia / Retromarcia/Ingombro rosso/ <i>Repeater / Parking / Stop / Reversing lamp / Rear fog lamp / Side marker red / Reflector</i>		
		Fissaggio <i>Fixing</i>	2 perni / 2 pivots		
		Lampade <i>Bulbs</i>	4 x P21W - 3 x R5W		
Connettore <i>Connector</i>				3.49.070.00	
Attacco laterale AMP 1.5 <i>Side connector AMP 1.5</i>					



SCANIA		SERIE 4			
	06→	Fanale posteriore <i>Rear lamp</i>	→	2.44.178.00	
		Con luce targa <i>With number plate light</i>	←	2.44.179.01	
		Trasparente <i>Lens</i>	→ ←	2.44.178.20	
		Funzioni <i>Functions</i>	7 - Passacavo laterale <i>7 - Cable side</i>		
		Servizi <i>Services</i>	Direzione / Posizione / Stop / Retronebbia / Retromarcia / Ingombro arancio / Catadiottro <i>Repeater / Parking / Stop / Reversing lamp / Rear fog lamp / Side marker / Reflector</i>		
		Fissaggio <i>Fixing</i>	2 perni / 2 pivots		
		Lampade <i>Bulbs</i>	4 x P21W - 3 x R5W		
		<p>* Ricambio di qualità equivalente Matching quality spare parts</p>			



SCANIA		SERIE 4			
	06→	Fanale posteriore <i>Rear lamp</i>	4.44.064.00		
		Con luce targa <i>With number plate light</i>	4.44.065.01		
		Trasparente <i>Lens</i>	 	2.44.178.20	
		Funzioni <i>Functions</i>	7 - Passacavo laterale 7 - Cable side		
		Servizi <i>Services</i>	Direzione / Posizione / Stop / Retronebbia / Retromarcia / Ingombro arancio / Catadiottro Repeater / Parking / Stop / Reversing lamp / Rear fog lamp / Side marker / Reflector		
		Fissaggio <i>Fixing</i>	2 perni / 2 pivots		
		Lampade <i>Bulbs</i>	4 x P21W - 3 x R5W		

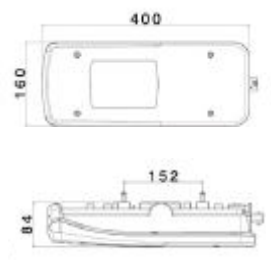

SCANIA		SERIE R			
  	06→	Fanale posteriore <i>Rear lamp</i>		2.44.180.00	
		Con luce targa <i>With number plate light</i>		2.44.181.01	
		Trasparente <i>Lens</i>	 	2.44.178.20	
		Funzioni <i>Functions</i>	7 - Attacco laterale DIN 6 Poli 7 - Side fitting 6 Pins		
		Servizi <i>Services</i>	Direzione / Posizione / Stop / Retronebbia / Retromarcia / Ingombro arancio / Catadiottro Repeater / Parking / Stop / Reversing lamp / Rear fog lamp / Side marker / Reflector		
		Fissaggio <i>Fixing</i>	2 perni / 2 pivots		
		Lampade <i>Bulbs</i>	4 x P21W - 3 x R5W		
Connettore Connector			3.49.070.00		
* Ricambio di qualità equivalente Matching quality spare parts					

SCANIA		SERIE R	
 	06→	Fanale posteriore <i>Rear lamp</i>	4.44.068.00
		Con luce targa <i>With number plate light</i>	4.44.069.01
		Trasparente <i>Lens</i>	4.44.068.70
		Fanale posteriore con segnale acustico <i>Rear lamp with reverse alarm</i>	 2.44.178.20 
		Funzioni <i>Functions</i>	7 - Attacco laterale DIN 6 Poli 7 - Side fitting 6 Pins
		Servizi <i>Services</i>	Direzione / Posizione / Stop / Retronebbia / Retromarcia / Ingombro arancio / Catadiottro <i>Repeater / Parking / Stop / Reversing lamp / Rear fog lamp / Side marker / Reflector</i>
		Fissaggio <i>Fixing</i>	2 perni / 2 pivots
Lampade <i>Bulbs</i>	4 x P21W - 3 x R5W		
Connettore <i>Connector</i>	3.49.070.00		

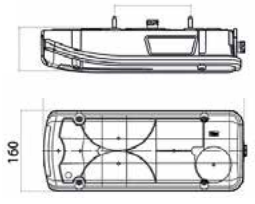
SCANIA		P & R	
  	06→	Fanale posteriore <i>Rear lamp</i>	 5.44.072.00
		Con luce targa <i>With number plate light</i>	 5.44.073.01
		Trasparente <i>Lens</i>	 5.44.070.20  5.44.071.20
		Funzioni <i>Functions</i>	7 - Attacco laterale DIN 6 Poli 7 - Side fitting 6 Pins
		Servizi <i>Services</i>	Direzione / Posizione / Stop / Retronebbia / Retromarcia / Ingombro arancio / Catadiottro <i>Repeater / Parking / Stop / Reversing lamp / Rear fog lamp / Side marker / Reflector</i>
		Fissaggio <i>Fixing</i>	2 perni / 2 pivots
		Lampade <i>Bulbs</i>	4 x P21W - 3 x R5W
Connettore <i>Connector</i>	3.49.070.00		

SCANIA	CF/XF		LC11 LED
	Fanale posteriore <i>Rear lamp</i>	→	5.44.114.80
	Fanale posteriore <i>Rear lamp</i>	←	5.44.115.80
	Fanale posteriore con targa <i>Rear lamp with number plate</i>	←	5.44.115.81
	Trasparente posteriore <i>Rear lens</i>	→	5.44.112.20
	Trasparente posteriore <i>Rear lens</i>	←	5.44.113.20
	Connettore Connector		3.49.070.00
	Funzioni <i>Functions</i>	7	
Servizi <i>Services</i>	Direzione / Posizione / Stop / Retronebbia / Retromarcia / Ingombro rosso <i>Repeater / Parking / Stop / Reversing lamp / Rear fog lamp / Side marker red / Reflector</i>		
Fissaggio <i>Fixing</i>	2 perni / 2 pivots		
Lampade <i>Bulbs</i>	4 x P21W - 3 x R5W		
Attacco laterale AMP 1.5 <i>Side connector AMP 1.5</i>			
			

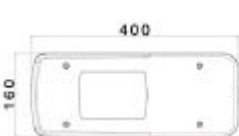
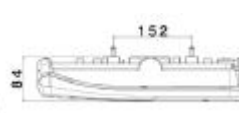
SCANIA	P&R		LC8	
	Fanale posteriore <i>Rear lamp</i>	→	5.44.110.00	
	Fanale posteriore con targa <i>With number plate light</i>	←	5.44.111.00	
	Funzioni <i>Functions</i>	7		
	Servizi <i>Services</i>	Direzione / Posizione / Stop / Retronebbia / Retromarcia / Ingombro rosso <i>Repeater / Parking / Stop / Reversing lamp / Rear fog lamp / Side marker red / Reflector</i>		
	Fissaggio <i>Fixing</i>	2 perni / 2 pivots		
Lampade <i>Bulbs</i>	4 x P21W - 3 x R5W			
Attacco posteriore AMP 1.5 <i>Rear connector AMP 1.5</i>				
				

SCANIA		P&R		LC11 LED	
	16→	Fanale posteriore / Rear lamp		→	5.44.112.80
		Fanale posteriore con targa / Rear lamp with number plate		←	5.44.113.81
		Trasparente posteriore / Rear lens		→	5.44.112.20
		Trasparente posteriore / Rear lens		←	5.44.113.20
		Connettore / Connector			3.49.070.00
		Funzioni Functions	7		
		Servizi Services	Direzione / Posizione / Stop / Retronebbia / Retromarcia / Ingombro rosso Repeater / Parking / Stop / Reversing lamp / Rear fog lamp / Side marker red / Reflector		
		Fissaggio Fixing	2 perni / 2 pivots		
Lampade Bulbs	4 x P21W - 3 x R5W				
Attacco posteriore AMP 1.5 Rear connector AMP 1.5					
					

SCANIA		SERIE R		
	06→	Fanale posteriore posizione stop Lampada P21/5W Stop repeater rear lamp P21/5W bulb		2.44.242.00
		Fanale posteriore retronebbia Lampada P21W Fog rear lamp P21W bulb		2.44.243.00
		Fanale direzione arancio Lampada P21W Orange repeater lamp P21W bulb		2.44.244.00
		Fanale anteriore incolore Lampada PY21W Clear front lamp PY21W bulb		2.44.246.00
		Fanale posteriore retromarcia Lampada PY21W Reverse rear lamp PY21W bulb		2.44.248.00
* Ricambio di qualità equivalente Matching quality spare parts				



VOLVO		6 PIN			
		Fanale posteriore / Rear lamp		→	2.44.174.00
				←	2.44.175.01
		Trasparente / Lens		→	2.44.174.20
				←	
		Funzioni Functions	7	Attacco Volvo Plug Rear Volvo Plug	
		Servizi Services	Direzione / Posizione / Stop / Retronebbia / Retromarcia / Ingombro arancio / Catadiottro Repeater / Parking / Stop / Reversing lamp / Rear fog lamp / Side marker / Reflector		
Fissaggio Fixing	2 perni / 2 pivots				
Lampade Bulbs	4 x P21W - 3 x R5W				
* Ricambio di qualità equivalente Matching quality spare parts					



VOLVO		FH - FM TRACTOR	
	05→	Fanale posteriore <i>Rear lamp</i>	→ 4.44.052.00 ← 4.44.053.00
		Fanale posteriore con segnale acustico <i>Rear lamp with reverse alarm</i>	→ 4.44.056.00
		Fanale posteriore con luce targa <i>Rear lamp with number plate light</i>	← 4.44.057.01
		Trasparente <i>Lens</i>	→ 4.44.052.20 ←
		Connettore <i>Connector</i>	3.49.070.00
		* Ricambio di qualità equivalente <i>Matching quality spare parts</i>	

VOLVO		FH - FM TRACTOR	
	05→	Fanale posteriore <i>Rear lamp</i>	→ 2.44.290.00
		Fanale posteriore con luce targa <i>Rear lamp with number plate light</i>	← 2.44.291.01
		Trasparente <i>Lens</i>	→ 2.44.290.20 ←
		Connettore <i>Connector</i>	3.49.070.00
		* Ricambio di qualità equivalente <i>Matching quality spare parts</i>	

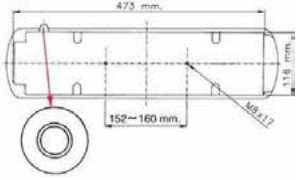

VOLVO		FH - FM	
	01→02	Fanale posteriore <i>Rear lamp</i>	→ 4.44.058.00 ← 4.44.059.00
		Fanale posteriore con segnale acustico <i>Rear lamp with reverse alarm</i>	→ 4.44.060.00
		Fanale posteriore con luce targa <i>Rear lamp with number plate light</i>	← 4.44.061.01
		Trasparente <i>Lens</i>	→ 4.44.058.20 ←
		Connettore <i>Connector</i>	3.49.070.00
		* Ricambio di qualità equivalente <i>Matching quality spare parts</i>	



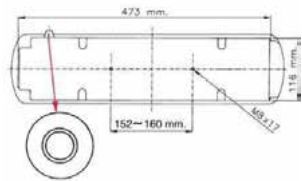

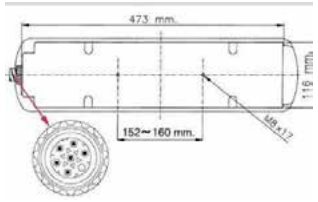

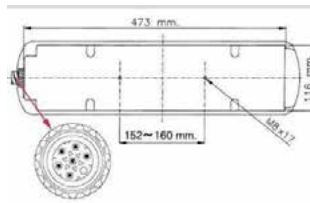

VOLVO		FH - FM	
	01→02	Fanale posteriore <i>Rear lamp</i>	→ 2.44.292.00
		Fanale posteriore con luce targa <i>Rear lamp with number plate light</i>	← 2.44.293.01
		Trasparente <i>Lens</i>	→ 2.44.292.20 ←
		Connettore <i>Connector</i>	3.49.070.00
		* Ricambio di qualità equivalente <i>Matching quality spare parts</i>	



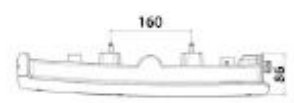

VOLVO		FH - FM - FL	
 	01→05	Fanale posteriore / <i>Rear lamp</i>	→ 2.44.188.00
		Fanale posteriore con luce targa <i>Rear lamp with number plate light</i>	← 2.44.189.01
		Trasparente / <i>Lens</i>	→ ← 2.44.178.20
		Funzioni <i>Functions</i>	7 - Con passacavo laterale / 7- Cable side
		Servizi <i>Services</i>	Direzione / Posizione / Stop / Retronebbia / <i>Repeater / Parking / Stop / Reversing lamp / Rear fog lamp / Side marker / Reflector</i>
		Fissaggio <i>Fixing</i>	2 perni / 2 pivots
Lampade <i>Bulbs</i>	4 x P21W - 3 x R5W		
* Ricambio di qualità equivalente Matching quality spare parts			

VOLVO		FH - FM - FL	
 	01→05	Fanale posteriore / <i>Rear lamp</i>	→ 4.44.066.01
		Fanale posteriore con luce targa <i>Rear lamp with number plate light</i>	← 4.44.067.01
		Trasparente / <i>Lens</i>	→ ← 2.44.178.20
		Funzioni <i>Functions</i>	7 - Con passacavo / 7- Cable side
		Servizi <i>Services</i>	Direzione / Posizione / Stop / Retronebbia / <i>Repeater / Parking / Stop / Reversing lamp / Rear fog lamp / Side marker / Reflector</i>
		Fissaggio <i>Fixing</i>	2 perni / 2 pivots
Lampade <i>Bulbs</i>	4 x P21W - 3 x R5W		

VOLVO		FH - FM - PRE 2001	
	01→05	Fanale posteriore / <i>Rear lamp</i>	→ 2.44.186.00
		Fanale posteriore con luce targa <i>Rear lamp with number plate light</i>	← 2.44.187.01
		Trasparente / <i>Lens</i>	→ ← 2.44.178.20
		Funzioni <i>Functions</i>	7 - Attacco laterale DIN 6 Poli 7 - Side fitting DIN 6 Pins
		Servizi <i>Services</i>	Direzione / Posizione / Stop / Retronebbia / <i>Repeater / Parking / Stop / Reversing lamp / Rear fog lamp / Side marker / Reflector</i>
		Fissaggio <i>Fixing</i>	2 perni / 2 pivots
Lampade <i>Bulbs</i>	4 x P21W - 3 x R5W		
* Ricambio di qualità equivalente Matching quality spare parts			

VOLVO		FH - FM - PRE 2001		
		Fanale posteriore <i>Rear lamp</i>	4.44.080.00	
		Fanale posteriore con luce targa <i>Rear lamp with number plate light</i>	4.44.081.01	
		Fanale posteriore con segnale acustico <i>Rear lamp with reverse alarm</i>	4.44.080.70	
		Trasparente <i>Lens</i>	  2.44.178.20	
	01→05	Funzioni <i>Functions</i>	7 - Attacco laterale DIN 6 Poli 7 - Side fitting DIN 6 Pins	
		Servizi <i>Services</i>	Direzione / Posizione / Stop/Retronebbia / Retromarcia / Ingombro arancio / Catadiottro <i>Repeater / Parking / Stop / Reversing lamp / Rear fog lamp/Side marker/Reflector</i>	
		Fissaggio <i>Fixing</i>	2 perni / 2 pivots	
		Lampade <i>Bulbs</i>	4 x P21W - 3 x R5W	
		Connettore / <i>Connector</i>	3.49.070.00	

VOLVO		FH 13		LC 10 LED	
		Fanale posteriore / <i>Rear lamp</i>		5.44.118.80	
		Fanale posteriore / <i>Rear lamp</i>		5.44.119.80	
		Fanale posteriore con targa / <i>Rear lamp with number plate</i>		5.44.119.81	
		Trasparente posteriore / <i>Rear lens</i>	 	5.44.118.20	
	13→	Funzioni / <i>Functions</i>			
		Servizi / <i>Services</i>			
		Fissaggio / <i>Fixing</i>			
		Lampade / <i>Bulbs</i>			
		Attacco laterale AMP 1.5 <i>Side connector AMP 1.5</i>			

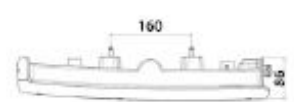
VOLVO		FM 12 EURO 6		LC 9 LED	
		Fanale posteriore / <i>Rear lamp</i>		5.44.108.80	
		Fanale posteriore / <i>Rear lamp</i>		5.44.109.80	
		Trasparente posteriore / <i>Rear lens</i>	 	5.44.108.20	
	12→	Funzioni / <i>Functions</i>			
		Servizi / <i>Services</i>			
		Fissaggio / <i>Fixing</i>			
		Lampade / <i>Bulbs</i>			
			Attacco laterale AMP 1.5 <i>Side connector AMP 1.5</i>		

VOLKSWAGEN		CRAFTER	
	06→	Gruppo ottico posteriore <i>Rear optical unit</i>	→ 2.44.214.10
			← 2.44.215.10
	* Ricambio di qualità equivalente <i>Matching quality spare parts</i>		

VOLKSWAGEN		TRANSPORTER LTZ	
	96→05	Fanale posteriore <i>Rear lamp</i>	→ 2.44.112.00
			← 2.44.113.00
	* Ricambio di qualità equivalente <i>Matching quality spare parts</i>		

UNIVERSALE			
	96→	Fanale posteriore / <i>Rear lamp</i>	→ 2.44.074.00
		Fanale posteriore con targa / <i>Rear lamp with number plate</i>	← 2.44.075.01
		Trasparente / <i>Lens</i>	→
			← 2.44.074.20
* Ricambio di qualità equivalente <i>Matching quality spare parts</i>			



UNIVERSALE		TRATTORI TRACTORS	
		Fanale posteriore <i>Rear lamp</i>	2.44.258.00
		Trasparente <i>Lens</i>	2.44.258.20
	* Ricambio di qualità equivalente <i>Matching quality spare parts</i>		

UNIVERSALE		RIMORCHI TRAILERS	
		Fanale posteriore <i>Rear lamp</i>	2.44.254.00
		Fanale posteriore con luce targa <i>Rear lamp with number plate light</i>	2.44.255.01
		Trasparente <i>Lens</i>	2.44.254.20
	* Ricambio di qualità equivalente <i>Matching quality spare parts</i>		

UNIVERSALE



 	Fanale posteriore / <i>Rear lamp</i>		2.44.066.00
	Fanale posteriore con luce targa <i>Rear lamp with number plate light</i>		2.44.067.00
	Trasparente <i>Lens</i>		2.44.066.20
	Connettore <i>Connector</i>		3.49.070.00
	Fanale posteriore con cavo / <i>Rear lamp with cable</i>	→	2.44.208.00
	Fanale posteriore con luce targa e cavo <i>Rear lamp with number plate light and cable</i>	←	2.44.209.01
* Ricambio di qualità equivalente Matching quality spare parts			

UNIVERSALE
LED

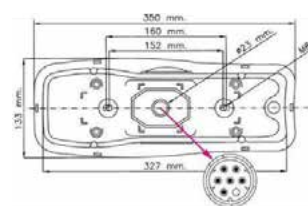
 	Fanale posteriore / <i>Rear lamp</i>	→	2.44.066.80
		←	2.44.067.80
	Fanale posteriore con cavo / <i>Rear lamp with cable</i>	→	2.44.208.80
		←	2.44.209.80
	Trasparente posteriore <i>Rear lens</i>		2.44.066.30
	Connettore <i>Connector</i>		3.49.070.00
Funzioni <i>Functions</i>	6		
Servizi <i>Services</i>	Stop, posizione, direzione, retromarcia, retronebbia, catadiottro <i>Rear lamp - Stop, parking, repeater, reversing lamp, rear fog lamp, reflector</i>		
Fissaggio <i>Fixing</i>			
Lampade <i>Bulbs</i>	Voltaggio <i>Voltage: 10-30V DC</i>		
* Ricambio di qualità equivalente Matching quality spare parts			

UNIVERSALE



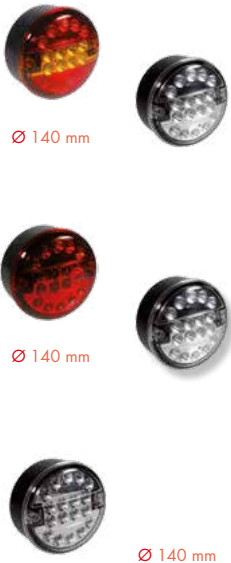

	96→	Fanale posteriore <i>Rear lamp</i>	→	2.44.076.01
			←	
		Trasparente posteriore <i>Rear lens</i>	→	2.44.076.20
			←	
* Ricambio di qualità equivalente Matching quality spare parts				





UNIVERSALE		38 LED	
 <p>Ø 103 mm</p> <p>Ø 103 mm</p> <p>Ø 103 mm</p>		Fanale posteriore 12V / <i>Rear lamp 12V</i>	2.44.092.80
		Fanale posteriore 24V / <i>Rear lamp 24V</i>	2.44.094.80
	96→	Fanale retronebbia 12V / <i>Fog lamp 12V</i>	2.44.096.80
		Fanale retronebbia 24V / <i>Fog lamp 24V</i>	2.44.098.80
		Fanale retromarcia 12V / <i>Reverse lamp 12V</i>	2.44.100.80
		Fanale retromarcia 24V / <i>Reverse lamp 24V</i>	2.44.102.80
* Ricambio di qualità equivalente <i>Matching quality spare parts</i>			





UNIVERSALE		18 LED	
 <p>Ø 140 mm</p> <p>Ø 140 mm</p> <p>Ø 140 mm</p>		Fanale posteriore stop - direzione - posizione <i>Rear lamp stop - repeater - parking</i>	2.44.084.80
		Fanale posteriore stop - direzione - posizione con trasparente incolore <i>Rear lamp parking - stop - repeater with clear lens 9V-33V</i>	2.44.086.80
	96→	Fanale retronebbia / Fog lamp 9V-33V	2.44.088.80
		Fanale retronebbia con trasparente incolore / Fog lamp 9V-33V <i>with clear lens</i>	2.44.087.80
		Fanale retromarcia 9V-33V / Reverse lamp 9V-33V	2.44.089.80
* Ricambio di qualità equivalente <i>Matching quality spare parts</i>			

UNIVERSALE		20 LED	
 <p>24 V Ø 135 mm</p> <p>24 V Ø 135 mm</p> <p>24 V Ø 135 mm</p>		Fanale posteriore / <i>Rear lamp</i>	2.44.268.80
	96→	Fanale posteriore retromarcia / <i>Rear reversing lamp</i>	2.44.270.80
		Fanale posteriore retronebbia / <i>Fog rear lamp</i>	2.44.271.80
* Ricambio di qualità equivalente <i>Matching quality spare parts</i>			

UNIVERSALE	RIMORCHI TRAILERS	LED 10 33V
	Fanale posteriore rimorchio con ingombro <i>Trailer rear lamp with side marker</i>	 2.44.192.81
	Fanale posteriore rimorchio con ingombro <i>Trailer rear lamp with side marker</i>	 2.44.193.81
	Funzioni / <i>Functions</i>	
	Servizi / <i>Services</i>	
	Fissaggio / <i>Fixing</i>	
	Lampade / <i>Bulbs</i>	mm. 434x130
* Ricambio di qualità equivalente Matching quality spare parts		

UNIVERSALE		LED 9 33V
   	Fanale anteriore direzione LED / <i>Repeater front lamp LED</i>	2.41.078.80
	Fanale direzione arancio LED / <i>Orange repeater lamp LED</i>	2.42.094.80
	Fanale posteriore LED 3 funzioni stop - posizione - direzione <i>Rear lamp repeater stop LED</i>	2.44.194.80
	Fanale posteriore rosso LED 2 funzioni stop - posizione	2.44.195.80
	Fanale posteriore retromarcia / <i>Red rear reverse lamp</i>	2.44.196.80
	Fanale posteriore retronebbia / <i>Rear lamp Fog lamp</i>	2.44.198.80
* Ricambio di qualità equivalente Matching quality spare parts		

UNIVERSALE	AUTOBUS	LED 9 33V
   	Fanale direzione / <i>Repeater lamp</i>	2.44.140.80
	Fanale posizione/stop / <i>Parking/stop lamp</i>	2.44.144.80
	Fanale retronebbia / <i>Rear fog lamp</i>	2.44.148.80
	Fanale retromarcia / <i>Reverse lamp</i>	2.44.152.80
* Ricambio di qualità equivalente Matching quality spare parts		



UNIVERSALE	AUTOBUS	LED 9 33V
 <p>10 cm</p>	Fanale posizione - stop <i>Parking/stop lamp</i>	2.44.156.80
	* Ricambio di qualità equivalente <i>Matching quality spare parts</i>	
UNIVERSALE	AUTOBUS	LED 9 33V
 <p>10 cm</p>	Fanale direzione <i>Repeater lamp</i>	2.44.160.80
	* Ricambio di qualità equivalente <i>Matching quality spare parts</i>	
UNIVERSALE	AUTOBUS	
 <p>10 cm</p>	Fanale catadiottro <i>Reflex reflector lamp</i>	2.44.162.80
	* Ricambio di qualità equivalente <i>Matching quality spare parts</i>	
UNIVERSALE	AUTOBUS	
	Fanale posizione Rosso / <i>Parking Red lamp</i>	2.44.168.00
	Fanale stop Rosso / <i>Stop Red lamp</i>	2.44.167.00
	Fanale posteriore Posizione-Stop Rosso / <i>Stop Red Rear Lamp</i>	2.44.166.00
	Fanale direzione anteriore Arancio / <i>Repeater Orange lamp</i>	2.41.076.00
	Fanale direzione posteriore Arancio / <i>Repeater Orange lamp</i>	2.44.169.00
	Fanale retromarcia / <i>Reverse lamp</i>	2.44.171.00
	Fanale retronebbia Rosso / <i>Rear fog lamp Red</i>	2.44.170.00
* Ricambio di qualità equivalente <i>Matching quality spare parts</i>		

UNIVERSALE		MODULO DI RICARICO		LED
 <p>75x61x19</p>		Aggiunge 10 Watt di carico per fanali a LED 24V <i>Reloading form only for LED lamps</i> <i>adds 10 Watt load for 24V LED lamps</i>		3.49.088.00
		Aggiunge 10 Watt di carico per fanali a LED 12V <i>Reloading form only for LED lamps</i> <i>adds 10 Watt load for 12V LED lamps</i>		3.49.089.00
	* Ricambio di qualità equivalente <i>Matching quality spare parts</i>			

UNIVERSALE				LED 24V
	96→	3° Luce Stop 20 LED <i>LED additional stop light</i>		2.44.204.80
	* Ricambio di qualità equivalente <i>Matching quality spare parts</i>			

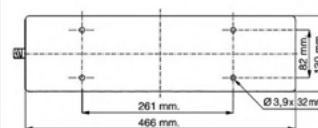
UNIVERSALE				
		Fanale posteriore 7 funzioni con cavo <i>Rear lamp 7 functions with cable</i>	→	2.44.262.00
		Fanale posteriore 7 funzioni con cavo <i>Rear lamp 7 functions with cable</i>	←	2.44.263.00
		Fanale posteriore 7 funzioni con cavo e targa <i>Rear lamp 7 functions with cable and number plate</i>	←	2.44.263.01
	Funzioni Functions	7		
	Servizi Services	Direzione / Posizione / Stop / Retronebbia/ Retromarcia / Ingombro arancio / Catadiottroa <i>Repeater / Parking / Stop / Reversing lamp / Rear fog lamp / Side marker / Reflector</i>		
Fissaggio Fixing	4 perni / 4 pivots			
Lampade Bulbs	4 x P21W - 3 x R5W			
* Ricambio di qualità equivalente <i>Matching quality spare parts</i>				







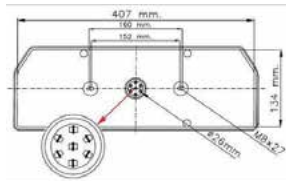

UNIVERSALE		LED		
	Fanale posteriore / <i>Rear lamp</i>	→	2.44.280.80	
	Fanale posteriore / <i>Rear lamp</i>	←	2.44.281.80	
	Fanale posteriore / <i>Rear lamp</i>	→	2.44.282.80	
	Fanale posteriore / <i>Rear lamp</i>	←	2.44.283.80	
	Funzioni <i>Functions</i>	7		
	Servizi <i>Services</i>	Posizione - stop - direzione - retronebbia targa - catadiotro <i>Rear position light-number plate light-brake direction indicator reversing light-rear fog light-reflective device</i>		
Fissaggio <i>Fixing</i>	2 perni mm. 304x48 2 pins mm. 304x48			
Lampade <i>Bulbs</i>	12/24V - cavo - cm. 150			
* Ricambio di qualità equivalente Matching quality spare parts				





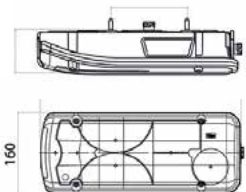

UNIVERSALE	RIMORCHI TRAILERS	LED
	Fanale posteriore 4 funzioni con catadiotro triangolare <i>Rear lamp 4 functions with triangular reflector</i>	2.44.250.80
	Fanale posteriore retromarcia <i>Rear reversing lamp</i>	2.44.252.80
* Ricambio di qualità equivalente Matching quality spare parts		

UNIVERSALE	RIMORCHI TRAILERS		
	Fanale posteriore / <i>Rear lamp</i>	→ 2.44.068.00	
		← 2.44.069.00	
	Trasparente / <i>Lens</i>	→ 2.44.068.20	
		← 2.44.069.20	
	Funzioni <i>Functions</i>	7	
	Servizi <i>Services</i>	Direzione / Posizione / Stop / Retronebbia / Retromarcia / Ingombro arancio / Catadiotro <i>Repeater / Parking / Stop / Reversing lamp / Rear fog lamp / Side marker / Reflector</i>	
Fissaggio <i>Fixing</i>	4 perni / 4 pivots		
Lampade <i>Bulbs</i>	4 x P21W - 3 x R5W		
Connettore / <i>Connector</i>		3.49.080.00	
* Ricambio di qualità equivalente Matching quality spare parts			

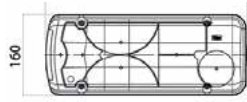

UNIVERSALE		RIMORCHI TRAILERS	
	Fanale posteriore / <i>Rear lamp</i>	→	2.44.104.00
		←	2.44.105.00
	Trasparente / <i>Lens</i>	→	2.44.068.20
		←	2.44.069.20
	Funzioni <i>Functions</i>	7	
	Servizi <i>Services</i>	Direzione / Posizione / Stop / Retronebbia / Retromarcia / Ingombro arancio / Catadiottro Repeater / Parking / Stop / Reversing lamp / Rear fog lamp / Side marker / Reflector	
	Fissaggio <i>Fixing</i>	4 perni / 4 pivots	
Lampade <i>Bulbs</i>	4 x P21W - 3 x R5W		
Con passacavo <i>With fairlead</i> * Ricambio di qualità equivalente Matching quality spare parts			

UNIVERSALE		LED 24V	
   	Fanale posteriore / <i>Rear lamp</i>	→	2.44.238.80
		←	2.44.239.80
	Fanale posteriore con luce targa <i>Rear lamp With number plate light</i>	←	2.44.239.81
	Trasparente / <i>Lens</i>	→	2.44.238.20
		←	2.44.238.20
	Connettore per 7 funzioni / <i>Connector 7 functions</i>		
Funzioni <i>Functions</i>	7		
Servizi <i>Services</i>	Direzione / Posizione / Stop / Retronebbia / Retromarcia / Ingombro arancio / Catadiottro Repeater / Parking / Stop / Reversing lamp / Rear fog lamp / Side marker / Reflector		
Fissaggio <i>Fixing</i>	2 perni / 2 pivots		
* Ricambio di qualità equivalente Matching quality spare parts			

UNIVERSALE		RIMORCHI TRAILERS	
   	Fanale posteriore / <i>Rear lamp</i>	→	5.44.074.00
		←	5.44.075.00
	Trasparente / <i>Lens</i>	→	5.44.074.20
		←	5.44.075.20
	Funzioni <i>Functions</i>	7	
	Servizi <i>Services</i>	Direzione / Posizione / Stop / Retronebbia / Retromarcia / Ingombro arancio / Catadiottro Repeater / Parking / Stop / Reversing lamp / Rear fog lamp / Side marker / Reflector	
	Fissaggio <i>Fixing</i>	2 perni / 2 pivots	
Lampade <i>Bulbs</i>	4 x P21W - 3 x R5W		
Connettore / <i>Connector</i>			3.49.070.00
			

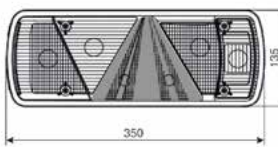
UNIVERSALE		RIMORCHI TRAILERS		LED		
   	96→05	Fanale posteriore / Con catadiottro triangolare <i>Rear lamp / With triangular reflex-reflector</i>	→	5.44.062.00	 	
		Trasparente / <i>Lens</i>	←	5.44.063.00		
		Funzioni <i>Functions</i>	7	→		5.44.062.20
		Servizi <i>Services</i>	Direzione / Posizione / Stop / Retronebbia / Retromarcia / Ingombro arancio / Catadiottro Repeater / Parking / Stop / Reversing lamp / Rear fog lamp / Side marker / Reflector	←		5.44.063.20
		Fissaggio <i>Fixing</i>	2 perni / 2 pivots			
		Lampade <i>Bulbs</i>	4 x P21W - 3 x R5W			
		Connettore / <i>Connector</i>		3.49.070.00		
						

UNIVERSALE		RIMORCHI E ECOPOINT				
	10→	Fanale posteriore / Con catadiottro triangolare <i>Rear lamp / With triangular reflex-reflector</i>	→	7.44.060.00		
		Trasparente / <i>Lens</i>	←	7.44.061.00		
		Funzioni <i>Functions</i>	7	→		7.44.060.20
		Servizi <i>Services</i>	Direzione / Posizione / Stop / Retronebbia / Retromarcia / Ingombro arancio / Catadiottro Repeater / Parking / Stop / Reversing lamp / Rear fog lamp / Side marker / Reflector	←		7.44.061.20
		Fissaggio <i>Fixing</i>	2 perni / 2 pivots			
		Lampade <i>Bulbs</i>	4 x P21W - 3 x R5W			
		Connettore / <i>Connector</i>		3.49.080.00		

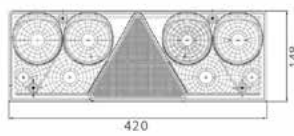
UNIVERSALE		SCHMITZ				
 		Fanale posteriore rimorchi <i>Rear lamp trailer</i>	→	7.44.056.00		
		Trasparente / <i>Lens</i>	←	7.44.057.00		
		Funzioni <i>Functions</i>	7	→		7.44.050.20
		Servizi <i>Services</i>	Direzione / Posizione / Stop / Retronebbia / Retromarcia / Ingombro arancio Repeater / Parking / Stop / Reversing lamp / Rear fog lamp / Side marker	←		
		Fissaggio <i>Fixing</i>	2 perni / 2 pivots			
		Lampade <i>Bulbs</i>	4 x P21W - 3 x R5W			
		Connettore / <i>Connector</i>		3.49.080.00		

UNIVERSALE	SCHMITZ		
	Fanale posteriore rimorchi / <i>Rear lamp trailer</i>	→	5.44.120.80
	Indicatore direzione dinamico / <i>Dynamic direction indicator</i>		
	Resistenza integrata / <i>Integrated resistance</i>	←	5.44.121.80
			

UNIVERSALE	SCHMITZ			
	Fanale posteriore rimorchi <i>Rear lamp trailer</i>	→	2.44.190.00	
		←	2.44.191.00	
	Trasparente <i>Lens</i>	→	2.44.190.20	
		←		
	Funzioni <i>Functions</i>	5		
	Servizi <i>Services</i>	Direzione / Posizione / Stop / Retronebbia / Retromarcia / Ingombro arancio / <i>Repeater / Parking / Stop / Reversing lamp / Rear fog lamp / Side marker</i>		
Fissaggio <i>Fixing</i>	2 perni / 2 pivots			
Lampade <i>Bulbs</i>	4 x P21W - 3 x R5W			
* Ricambio di qualità equivalente <i>Matching quality spare parts</i>				

UNIVERSALE	SCHMITZ			
	Fanale posteriore rimorchi <i>Rear lamp trailer</i>	→	7.44.058.00	
		←	7.44.059.00	
	Trasparente <i>Lens</i>	→	7.44.050.20	
		←		
	Funzioni <i>Functions</i>	7		
	Servizi <i>Services</i>	Direzione / Posizione / Stop / Retronebbia / Retromarcia / Ingombro arancio <i>Repeater / Parking / Stop / Reversing lamp / Rear fog lamp / Side marker</i>		
Fissaggio <i>Fixing</i>	2 perni / 2 pivots			
Lampade <i>Bulbs</i>	4 x P21W - 3 x R5W			
	Connettore / <i>Connector</i>		3.49.080.00	

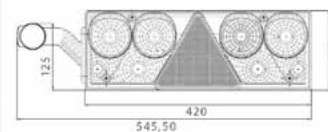

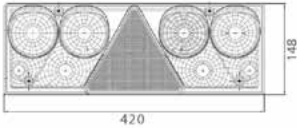
UNIVERSALE		RIMORCHI		
		Fanale posteriore Europoint II <i>Rear lamp Europoint II</i>	→ 7.44.050.00	
			← 7.44.051.00	
		Trasparente posteriore Europoint II <i>Rear lens Europoint II</i>	→ 7.44.050.20	
			← 7.44.050.20	
		Funzioni <i>Functions</i>	7	
		Servizi <i>Services</i>	Direzione/Posizione/Stop/Retronebbia /Retromarcia/Ingombro arancio/ <i>Repeater/Parking/Stop/Reversing lamp/Rear fog lamp/Side marker/</i>	
Fissaggio <i>Fixing</i>	2 perni / 2 pivots			
Lampade <i>Bulbs</i>	4 x P21W - 3 x R5W			
	Connettore / Connector	3.49.080.00		

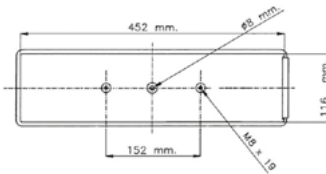
UNIVERSALE		RIMORCHI TRAILERS		
	94→01	Fanale posteriore Europoint II <i>Rear lamp Europoint II</i>	→ 7.44.054.00	
			← 7.44.055.00	
		Trasparente posteriore Europoint II <i>Rear lens Europoint II</i>	→ 7.44.054.20	
			← 7.44.054.20	
		Funzioni <i>Functions</i>	7	
		Servizi <i>Services</i>	Direzione/Posizione/Stop/Retronebbia Retromarcia/Ingombro arancio/ <i>Repeater/Parking/Stop/Reversing lamp Rear fog lamp/Side marker/</i>	
Fissaggio <i>Fixing</i>	2 perni / 2 pivots			
Lampade <i>Bulbs</i>	4 x P21W - 3 x R5W			

UNIVERSALE		RIMORCHI - LECININA MISTRALL	
	83→92	Fanale posteriore <i>Rear lamp</i>	→ 2.44.288.00
		6 funzioni / 6 functions	← 2.44.289.00
		Trasparente posteriore <i>Rear lens</i>	→ 2.44.288.20
			← 2.44.289.20
* Ricambio di qualità equivalente <i>Matching quality spare parts</i>			

UNIVERSALE

 Fanale posteriore
Rear lamp

1.44.068.00

1.44.069.00

 Trasparente
Lens

1.44.058.20

1.44.059.20

 Funzioni
Functions

5

 Servizi
Services

 Direzione / Posizione / Stop / Retromarcia /
 Catadiottro
*Repeater / Parking / Stop / Reversing lamp /
 Reflector*

 Fissaggio
Fixing

2 perni / 2 pivots

 Lampade
Bulbs

4 x P21W - 3 x R5W

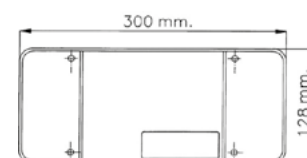
UNIVERSALE

200x110

 Fanale posteriore con targa e retromarcia
Rear lamp with number plate light and Reversing lamp

2.44.224.00

 Fanale posteriore con targa e retronebbia
Rear lamp with number plate light and Rear fog lamp

2.44.225.00

 Trasparente con retromarcia
Lens with reversing lamp

2.44.224.20

 Trasparente con retronebbia
Lens with Rear fog lamp

2.44.225.20

 Funzioni
Functions

5

 Servizi
Services

 Direzione / Posizione / Stop / Retronebbia /
 Retromarcia
*Repeater / Parking / Stop / Reversing lamp /
 Rear fog lamp / Side marker*

 Fissaggio
Fixing

2 perni / 2 pivots

Interasse 55mm.

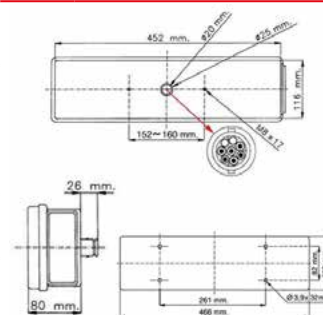
 * Ricambio di qualità equivalente | **Matching quality spare parts**

UNIVERSALE



200x240

Fanale posteriore con targa e retromarcia
Rear lamp with number plate light and reversing lamp



2.44.226.00



Fanale posteriore con targa e retronebbia
Rear lamp with number plate light and Rear fog lamp



2.44.227.00



Trasparente con retromarcia
Lens with reversing lamp



2.44.226.20



Trasparente con retronebbia
Lens with Rear fog lamp



2.44.227.20



Funzioni
Functions

5

Servizi
Services

Direzione / Posizione / Stop / Retronebbia /
Retromarcia
*Repeater / Parking / Stop / Reversing lamp /
Rear fog lamp / Side marker*

Fissaggio
Fixing

2 perni / 2 pivots

Interasse 55mm

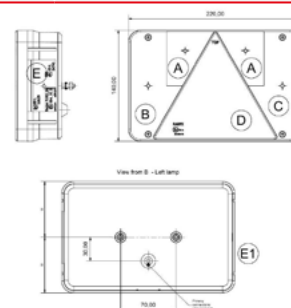

*** Ricambio di qualità equivalente | Matching quality spare parts**

UNIVERSALE

COBINO



Fanale posteriore / *Rear lamp*



2.44.106.00



Fanale posteriore con targa
Rear lamp with number plate



2.44.107.01

Trasparente posteriore
Rear lens



2.44.106.20





Trasparente posteriore con targa
Rear lens with number plate



2.44.107.21

*** Ricambio di qualità equivalente | Matching quality spare parts**

UNIVERSALE	AUTOBUS TRUCKS	
	Fanale posteriore posizione / <i>Rear parking lamp</i>	2.44.128.00
	Fanale posteriore stop / <i>Rear stop lamp</i>	2.44.130.00
	Fanale posteriore retronebbia / <i>Rear fog lamp</i>	2.44.132.00
	Trasparente rosso / <i>Red lens</i>	2.44.128.21
	Fanale posteriore direzione / <i>Rear repeater lamp</i>	2.44.134.00
	Trasparente arancio / <i>Orange lens</i>	2.44.134.11
	Fanale posteriore retromarcia / <i>Rear reversing lamp</i>	2.44.136.00
	Trasparente incoloro / <i>Clear lens</i>	2.44.136.25
* Ricambio di qualità equivalente <i>Matching quality spare parts</i>		



UNIVERSALE	EUROPOINT III	
	Fanale posteriore <i>Rear lamp</i>	 7.44.092.00
	Fanale posteriore <i>Rear lamp</i>	 7.44.093.00
Luce di posizione con guida luce <i>Position light with light guides</i>		

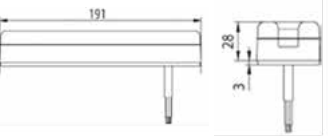
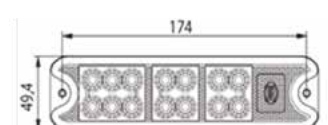

UNIVERSALE		LED 24V	
	Fanale posteriore / <i>Rear lamp</i>	→	2.44.090.80
		←	
	Fanale posteriore / <i>Rear lamp</i>	→	2.44.091.80
		←	
* Ricambio di qualità equivalente <i>Matching quality spare parts</i>			







UNIVERSALE		LED 10 30V	
	Fanale posteriore / <i>Rear lamp</i>	→	2.44.210.80
		←	
	Funzioni <i>Functions</i>	3	
	Servizi <i>Services</i>	Direzione / Posizione / Catadiottro <i>Parking / Stop repeater with reflex / Reflector</i>	
	Fissaggio <i>Fixing</i>	Base piana <i>Flate base</i>	
14 LED			
* Ricambio di qualità equivalente <i>Matching quality spare parts</i>			



UNIVERSALE		LED 10 30V	
	Fanale posteriore / <i>Rear lamp</i>	→	2.44.212.80
		←	
	Fanale posteriore / <i>Rear lamp</i>	→	2.44.213.80
		←	
	Funzioni <i>Functions</i>	4	
Servizi <i>Services</i>	Direzione / Stop / Posizione / Catadiottro <i>Parking / Stop repeater with reflex / Reflector</i>		
Fissaggio <i>Fixing</i>	Base piana <i>Flate base</i>		
14 LED			
* Ricambio di qualità equivalente <i>Matching quality spare parts</i>			

UNIVERSALE		LED 24V		
			2.44.082.80	
			2.44.083.80	
	Funzioni <i>Functions</i>	5		
	Servizi <i>Services</i>	Direzione / Posizione / Stop / Sinistro Retronebbia / Destra Retromarcia / Ingombro arancio <i>Repeater / Parking / Stop / SX Reversing lamp / DX Rear fog lamp / Side marker</i>		
	Fissaggio <i>Fixing</i>	2 perni / 2 pivots		
				
* Ricambio di qualità equivalente Matching quality spare parts				

UNIVERSALE	ECOLED	LED 24V	
	Fanale posteriore <i>Rear lamp</i>		7.44.090.80
	Fanale posteriore <i>Rear lamp</i>		7.44.091.80
	Connettore / <i>Connector</i>		3.49.080.00

UNIVERSALE	EUROPOINT III	LED	
	Fanale posteriore <i>Rear lamp</i>		7.44.094.80
	Fanale posteriore <i>Rear lamp</i>		7.44.095.80
	Connettore / <i>Connector</i>		3.49.080.00

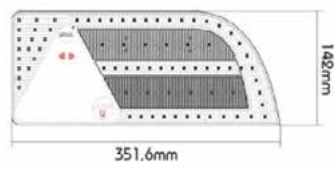
UNIVERSALE	EUROPOINT III	LED	
 	Fanale posteriore <i>Rear lamp</i>		7.44.096.80
	Fanale posteriore <i>Rear lamp</i>		7.44.097.80
	Trasparente posteriore <i>Rear lens</i>		7.44.096.20
	Trasparente posteriore <i>Rear lens</i>		7.44.097.20
	Connettore / <i>Connector</i>		3.49.080.00

UNIVERSALE	RIMORCHI		LED 12 24V	
	Fanale posteriore <i>Rear lamp</i>	→	7.44.098.80	
		←	7.44.099.80	
	Funzioni <i>Functions</i>	5		
	Servizi <i>Services</i>	Direzione / Posizione / Stop / Retronebbia Retromarcia / Ingombro arancio <i>Repeater / Parking / Stop / Reversing lamp / Rear fog lamp / Side marker</i>		
	Fissaggio <i>Fixing</i>	2 perni 2 pivot		
	cavo mm. 500 - cable mmn. 500			
				

UNIVERSALE	RIMORCHI		
	Fanale posteriore <i>Rear lamp</i>	→	5.44.126.00
	Fanale posteriore <i>Rear lamp</i>	←	5.44.127.00
	Trasparente posteriore <i>Rear lens</i>	→	5.44.126.20
	Trasparente posteriore <i>Rear lens</i>	←	5.44.127.20
	Connettore / Connector AMP 1,5		

UNIVERSALE	RIMORCHI		
	Fanale posteriore <i>Rear lamp</i>	→	5.44.128.00
	Fanale posteriore <i>Rear lamp</i>	←	5.44.129.00
	Trasparente posteriore <i>Rear lens</i>	→	5.44.128.20
	Trasparente posteriore <i>Rear lens</i>	←	5.44.129.20
	Con passacavo / With fairlead		

FIAT		DUCATO MY 2006	
	06→	Proiettore (H1+H7) / Headlamp (H1+H7)	→ 8.40.058.00
		Proiettore (H1+H7) / Headlamp (H1+H7)	← 8.40.059.00

FIAT		DUCATO MY 2006	
	12→	Proiettore con DRL (H7+H15) / Headlamp with DRL (H7+H15)	→ 8.40.088.00
		Proiettore con DRL (H7+H15) / Headlamp with DRL (H7+H15)	← 8.40.089.00
		Briglia adattatore / Adapter -> 10	8.40.088.19
		Con motorino With device	

FIAT		DUCATO FL (X250)	
	14→	Proiettore (H7) / Headlamp (H7)	→ 8.40.104.00
		Proiettore (H7) / Headlamp (H7)	← 8.40.105.00
			Senza fendinebbia

FIAT		DUCATO FL (X250)	
	14→	Proiettore (H7) + led DRL / Headlamp (H7) + led DRL	→ 8.40.106.00
		Proiettore (H7) + led DRL / Headlamp (H7) + led DRL	← 8.40.107.00
			Senza fendinebbia

IVECO		115/17 - 135/17 - 145/17	
	89→	Gruppo ottico H4 Manuale Optical unit Manual	→ ← 8.40.100.00
		* Ricambio di qualità equivalente Matching quality spare parts	

IVECO		DAILY OM GRINTA		
	78→	Proiettore (H4) Headlamp (H4)	↔	8.40.086.00
		* Ricambio di qualità equivalente Matching quality spare parts		

IVECO		DAILY		
	06→	Proiettore (H4) / Headlamp (H4)	↔	8.40.060.00
		Proiettore (H4) / Headlamp (H4)	↔	8.40.061.00
		Completo di motorino With device		

IVECO		DAILY 2000		
	00→06	Proiettore (H1+H7) Headlamp (H1+H7)	↔	8.40.066.00
		Proiettore (H1+H7) Headlamp (H1+H7)	↔	8.40.067.00
		Completo di motorino With device		

IVECO		DAILY		
	11→	Proiettore (H7+H1) Headlamp (H7+H1)	↔	8.40.090.00
		Proiettore (H7+H1) Headlamp (H7+H1)	↔	8.40.091.00
		Completo di motorino With device		

IVECO		DAILY		
	14→	Proiettore (H1+H7) / Headlamp (H1+H7)	↔	8.40.102.00
		Proiettore (H1+H7) / Headlamp (H1+H7)	↔	8.40.103.00
		Completo di motorino With device		

IVECO		EUROCARGO	
	91→02	Motorino elettrico <i>Small electrical device</i>	8.40.056.70

IVECO		EUROTRAKKER	
	02→	Proiettore (H4) <i>Headlamp (H4)</i>	➔ 8.40.068.00
		Proiettore (H4) <i>Headlamp (H4)</i>	➔ 8.40.069.00
	Completo di motorino <i>With device</i>		

IVECO		EUROTRAKKER	
	03→	Proiettore (H4) <i>Headlamp (H4)</i>	➔ 8.40.092.00
		Proiettore (H4) <i>Headlamp (H4)</i>	➔ 8.40.093.00
	Predisposto correttore elettrico <i>With predisposition for electrical adjustment</i>		















IVECO		STRALIS	
	02→07	Proiettore (H7+H7) <i>Headlamp (H7+H7)</i>	➔ 8.40.042.00
		Proiettore (H7+H7) <i>Headlamp (H7+H7)</i>	➔ 8.40.043.00
	Completo di motorino <i>With device</i>		

IVECO		SERIE Z	
	87→	Proiettore (H4) <i>Headlamp (H4)</i>	➔ 8.40.070.00
		Proiettore (H4) <i>Headlamp (H4)</i>	➔ 8.40.071.00

NISSAN		CABSTAR	
	06→	Proiettore (H4) Headlamp (H4)	➔ 8.40.076.00
		Proiettore (H4) Headlamp (H4)	➔ 8.40.077.00
	Completo di motorino With device		

NISSAN		CABSTAR	
	06→	Proiettore (HB4+HB4) Headlamp (HB4+HB4)	➔ 8.40.078.00
		Proiettore (HB4+HB4) Headlamp (HB4+HB4)	➔ 8.40.079.00
	Completo di motorino With device		

NISSAN		CABSTAR	
	08→	Proiettore (HB4+HB4) Headlamp (HB4+HB4)	➔ 8.40.080.00
		Proiettore (HB4+HB4) Headlamp (HB4+HB4)	➔ 8.40.081.00
	Completo di motorino With device		

FIAT		DUCATO		
	02→	Fendinebbia (H1) Fog lamp (H1)	 	8.20.054.00
		Staffa grigia Grey bracket		
IVECO		DAILY 2014		
	14→	Fendinebbia (H1) Fog lamp (H1)	 	8.20.100.00
IVECO		STRALIS		
	02→07	Fendinebbia (H1) Fog lamp (H1)	 	8.50.054.00
IVECO		STRALIS		
	02→07	Fendinebbia (H1) Fog lamp (H1)	 	8.50.056.00
IVECO		STRALIS		
	07→	Fendinebbia (H1) Fog lamp (H1)	 	8.50.058.00
		* Ricambio di qualità equivalente Matching quality spare parts		











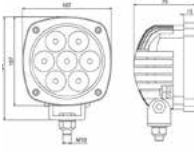

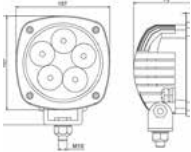
IVECO		STRALIS		
	07→	Proiettore profondità (H1) <i>Long beam (H1)</i>	→ ←	8.50.060.00
		* Ricambio di qualità equivalente <i>Matching quality spare parts</i>		

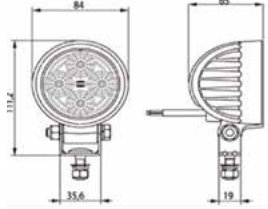

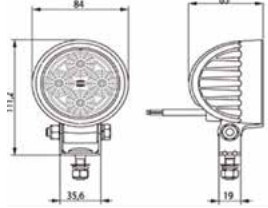

IVECO		STRALIS		
	07→12	Mascherina fendinebbia <i>Fog lamp grill</i>	→	8.50.058.17
		Mascherina fendinebbia <i>Fog lamp grill</i>	←	8.50.059.17
		* Ricambio di qualità equivalente <i>Matching quality spare parts</i>		

MAN		2000 EVOLUTION TG TGL TGM		
	98→	Fendinebbia <i>Fog lamp</i>	→	8.50.062.00
		Fendinebbia <i>Fog lamp</i>	←	8.50.063.00
		* Ricambio di qualità equivalente <i>Matching quality spare parts</i>		

MAN		2000 EVOLUTION TG TGL TGM		
	98→	Fendinebbia <i>Fog lamp</i>	→	8.50.064.00
		Fendinebbia <i>Fog lamp</i>	←	8.50.065.00
		* Ricambio di qualità equivalente <i>Matching quality spare parts</i>		

UNIVERSALE		LED		
		Faro lavoro / <i>Working lamp</i>	→ ←	3.47.058.00
		Flusso luminoso 1200 Lumen / <i>Luminous flux 1200 Lumen</i>		
		Voltaggio 10-30V DC <i>Voltage 10-30V DC</i> 8 LED 3W		
* Articolo universale <i>Universal part</i>				

UNIVERSALE	 <p>Faro lavoro / Working lamp</p> <p>Flusso luminoso 4000 Lumen 6500K <i>Luminous flux 4000 Lumen 6500K</i></p> <p>Voltaggio 10-30V DC Voltage 10-30V DC 7 LED 35 W</p>		LED 3.47.076.80 
UNIVERSALE	 <p>Faro lavoro / Working lamp</p> <p>Flusso luminoso 7000 Lumen 6500K <i>Luminous flux 7000 Lumen 6500K</i></p> <p>Voltaggio 10-30V DC Voltage 10-30V DC 10 LED 50W</p>		LED 3.47.078.80 
UNIVERSALE	 <p>Proiettore profondità <i>Long beam headlamp</i></p> <p>Flusso luminoso 600 Lumen <i>Luminous flux 600 Lumen</i></p> <p>Voltaggio 10-30V DC Voltage 10-30V DC 4 LED 3W</p>	 	LED 3.47.062.00 
UNIVERSALE	 <p>Proiettore profondità <i>Long beam headlamp</i></p> <p>Flusso luminoso 600 Lumen <i>Luminous flux 600 Lumen</i></p> <p>Voltaggio 10-30V DC Voltage 10-30V DC 4 LED 3W</p>	 	LED 3.47.064.00 
UNIVERSALE	 <p>Faro lavoro diametro 116 mm. <i>Work head lamp Diam. 116 mm.</i></p> <p>9 led 27W/ 9 led 27W Voltaggio Voltage: 10-30V Diam. 116 mm. Dimensioni Dimension: 137x120 mm. x 68 mm. Colore: nero Color: black Temperatura Temperature: 6000-6500K</p> <p>* Ricambio di qualità equivalente Matching quality spare parts</p>	LED 3.47.072.80	

UNIVERSALE			LED
	<p>Faro lavoro <i>Working lamp</i></p> <p>10-30V DC 650K IP67 5 LED 3W = 15W</p> <p>* Articolo universale Universal part</p>		<p>3.47.066.80</p>
	<p>Faro lavoro <i>Working lamp</i></p> <p>10-30V DC 650K IP67 7 LED 3W = 21W</p> <p>* Articolo universale Universal part</p>		<p>3.47.068.80</p>
	<p>Faro lavoro <i>Working lamp</i></p> <p>10-30V DC 650K IP67 9 LED 3W = 27W</p> <p>* Articolo universale Universal part</p>		<p>3.47.070.80</p>
	<p>Lampada ispezione officina <i>Workshop inspection lamp</i></p> <p>Caratteristiche lampada:</p> <ul style="list-style-type: none"> - pinza telescopica alluminio (110-185cm) <i>Telescopic aluminium gripper</i> - due magneti 2 magnets - temperatura luce: 5700-6000K <i>Light temperature</i> - 42 x LED Osram Opto Semiconductors 1050LM <p>Accessori inclusi</p> <ul style="list-style-type: none"> - caricatore 50Hz AC230V <i>Charger</i> - presa per accendisigari DC 12V <i>Lighter-plug</i> - cablaggio USB <i>Wiring USB</i> <p>Batteria: 3.7V 1800mAh Li-Ion <i>Battery</i> Corrente di carica: 12V 500mA <i>Charge current</i> Dimensioni della lampada: 900x28mm. <i>Lamp dimensions</i></p> <p>* Articolo universale Universal part</p>		<p>3.47.074.80</p>

FIAT		DUCATO	
	93→01	Fanali targa <i>Number plate light</i>	1.45.054.00

FIAT		DUCATO	
	02→	Fanali targa <i>Number plate light</i>	1.45.064.00

FIAT		DUCATO	
	11→	Fanali targa <i>Number plate light</i>	1.45.068.00

FIAT		SCUDO	
	95→06	Fanali targa <i>Number plate light</i>	1.45.062.00

FIAT IVECO		UNIVERSALE	
		Fanali targa <i>Number plate light</i>	➔ 2.45.050.00
		Fanali targa <i>Number plate light</i>	➔ 2.45.051.00
		* Ricambio di qualità equivalente <i>Matching quality spare parts</i> 	







FIAT IVECO		UNIVERSALE	
		Fanali targa Number plate light	→ 2.45.052.00
		Fanali targa Number plate light	← 2.45.053.00
		* Ricambio di qualità equivalente Matching quality spare parts 	

FORD		TRANSIT MK 2	
	→85	Fanale targa Number plate light	↔ 2.45.080.00
		* Ricambio di qualità equivalente Matching quality spare parts	

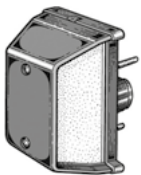
IVECO		DAILY	
	06→	Fanali targa Number plate light	1.45.066.00

IVECO OM		DAILY GRINTA	
	89→	Fanali targa Number plate light	1.45.052.00

IVECO		IRISBUS	
		Fanali targa Number plate light	1.45.050.00

RENAULT OPEL		MASTER MOVANO	
	99→	Fanali targa Number plate light	1.45.060.00
VIBERTI		VARIOUS TRACK	
		Fanale targa Number plate light	→ 2.45.082.00
		Fanale targa Number plate light	← 2.45.083.00
		* Ricambio di qualità equivalente Matching quality spare parts	
UNIVERSALE			
		Fanali targa Number plate light	2.45.054.00
		* Ricambio di qualità equivalente Matching quality spare parts 	
UNIVERSALE			
		Fanali targa nero Black number plate light	2.45.056.00
		Fanali targa rosso Red number plate light	2.45.058.00
		* Ricambio di qualità equivalente Matching quality spare parts 	
UNIVERSALE		6 LED	LED 24V
		Fanali targa nero Black number plate light	2.45.062.00
		Fanali targa con luce di posizione rosso Red number plate light with light parking	2.45.060.00
		* Ricambio di qualità equivalente Matching quality spare parts 	

UNIVERSALE		
	Fanali targa rosso <i>Red number plate light</i>	7.45.052.00
	Fanali targa nero <i>Black number plate light</i>	2.45.066.00

UNIVERSALE	RIMORCHI MOTRICE	LED 24V
	Fanali targa rosso <i>Red number plate light</i>	2.45.070.80
	* Ricambio di qualità equivalente <i>Matching quality spare parts</i>	

UNIVERSALE	RIMORCHI MOTRICE	LED 24V
	Fanali targa nero <i>Black number plate light</i>	2.45.072.80
	* Ricambio di qualità equivalente <i>Matching quality spare parts</i>	

UNIVERSALE	RIMORCHI MOTRICE	LED 24V
	Fanali targa nero <i>Black number plate light</i>	2.45.068.80
	* Ricambio di qualità equivalente <i>Matching quality spare parts</i>	

UNIVERSALE		
	Fanali targa <i>Number plate light</i>	2.45.064.00
* Ricambio di qualità equivalente <i>Matching quality spare parts</i>		

UNIVERSALE	4 LED	LED 12 24V
	Fanali targa <i>Number plate light</i>	2.45.074.80 * Ricambio di qualità equivalente <i>Matching quality spare parts</i>
	Fanali targa <i>Number plate light</i>	2.45.076.00 * Ricambio di qualità equivalente <i>Matching quality spare parts</i>
	Fanali targa <i>Number plate light</i>	2.45.078.80 * Ricambio di qualità equivalente <i>Matching quality spare parts</i>
	Scatola derivazione 170x110x73 mm. <i>Branch box 170x110x73 mm.</i>	2.44.234.00 N° 8 connettori di collegamento <i>8 connectors</i> 

FIAT		DUCATO	
	94→	Catadiottro Reflector	1.46.052.00

RENAULT OPEL		MASTER MOVANO	
	99→	Catadiottro Reflector	1.46.050.00

UNIVERSALE		Ø 60 mm.	
		Rosso con faro di fissaggio <i>Red with fixing hole reflector</i>	4.46.058.90
		Arancio con faro di fissaggio <i>Orange with fixing hole reflector</i>	4.46.058.91
		Incolore con faro di fissaggio <i>Clear with fixing hole reflector</i>	4.46.058.92
		* Articolo universale Universal part	

UNIVERSALE		Ø 60 mm.	
		Rosso con base adesiva <i>Red with adhesive base</i>	4.46.062.90
		Arancio con base adesiva <i>Orange with adhesive base</i>	4.46.062.91
		Incolore con base adesiva <i>Clear with adhesive base</i>	4.46.062.92
		* Articolo universale Universal part	

UNIVERSALE		Ø 60 mm.	
	Rosso con perno di fissaggio <i>Red with fixing pin</i>		4.46.054.90
	Arancio con perno di fissaggio <i>Orange with fixing pin</i>		4.46.054.91
	Incolore con perno di fissaggio <i>Clear with fixing pin</i>		4.46.054.92
	* Articolo universale Universal part		

UNIVERSALE		Ø 80 mm.	
	Rosso con foro di fissaggio <i>Red with fixing hole reflector</i>		4.46.060.90
	Arancio con foro di fissaggio <i>Orange with fixing hole reflector</i>		4.46.060.91
	Incolore con foro di fissaggio <i>Clear with fixing hole reflector</i>		4.46.060.92
	* Articolo universale Universal part		

UNIVERSALE		Ø 80 mm.	
	Rosso con base adesiva <i>Red with adhesive base</i>		4.46.064.90
	Arancio con base adesiva <i>Orange with adhesive base</i>		4.46.064.91
	Incolore con base adesiva <i>Clear with adhesive base</i>		4.46.064.92
	* Articolo universale Universal part		

UNIVERSALE	Ø 80 mm.		
	Rosso con perno di fissaggio <i>Red with fixing pin</i>		4.46.056.90
	Arancio con perno di fissaggio <i>Orange with fixing pin</i>		4.46.056.91
	Incolore con perno di fissaggio <i>Clear with fixing pin</i>		4.46.056.92
	* Articolo universale Universal part		

UNIVERSALE	103 X 51 mm.		
	Rosso con base adesiva <i>Red with adhesive base</i>		4.46.068.90
	Arancio con base adesiva <i>Orange with adhesive base</i>		4.46.068.91
	Incolore con base adesiva <i>Clear with adhesive base</i>		4.46.068.92
	* Articolo universale Universal part		

UNIVERSALE	127 X 51 mm.		
	Rosso con faro di fissaggio <i>Red with fixing hole reflector</i>		4.46.070.90
	Arancio con faro di fissaggio <i>Orange with fixing hole reflector</i>		4.46.070.91
	Incolore con faro di fissaggio <i>Clear with fixing hole reflector</i>		4.46.070.92
	* Articolo universale Universal part		

UNIVERSALE	63 X 51 mm.	
	Rosso con perno di fissaggio <i>Red with fixing pin</i>	4.46.066.90
	Arancio con perno di fissaggio <i>Orange with fixing pin</i>	4.46.066.91
	Incolore con perno di fissaggio <i>Clear with fixing pin</i>	4.46.066.92
	* Articolo universale Universal part	

UNIVERSALE	RIMORCHI TRAILERS	
	Rosso con 2 perni <i>Red with 2 pin fixing</i>	4.46.072.90
* Articolo universale Universal part		

UNIVERSALE	RIMORCHI TRAILERS	
	Rosso con 2 fori <i>Red 2 screw fixing</i>	4.46.074.90
Interasse 70 mm. <i>Distance between centers 70 mm.</i>		
* Articolo universale Universal part		

UNIVERSALE	RIMORCHI TRAILERS	
	Rosso con 2 fori <i>Red 2 screw fixing</i>	4.46.076.90
Interasse 85 mm. <i>Distance between centers 85 mm.</i>		
* Articolo universale Universal part		

FIAT		DUCATO	
	94→	Plafoniera <i>Dome lamp</i>	1.48.056.00

FIAT		DUCATO	
	94→	Plafoniera <i>Dome lamp</i>	1.48.058.00
		Grigio 670 <i>Grey 670</i>	

IVECO			
	94→	Plafoniera <i>Dome lamp</i>	1.48.060.00
		Nera <i>Black</i>	

IVECO		VARIOUS		LED 12V	
	13→	Plafoniera interna nera <i>Black dome lamp</i>			1.48.060.80

IVECO		EUROCARGO EUROSTAR EUROTECH	
	03→	Spot mobile <i>Mobile spot</i>	1.48.074.00
		Nera <i>Black</i>	

UNIVERSALE	AUTOBUS	
	Plafoniera <i>Dome lamp</i>	1.48.054.00
	Con lampada incandescenza <i>With bulb</i>	

UNIVERSALE	AUTOBUS	LED 12V
	Plafoniera - 34 LED <i>Dome lamp - 34 LED</i>	2.48.050.80
	Plafoniera - 34 LED <i>Dome lamp - 34 LED</i>	
	135 x 70 mm. - Accensione a tatto 135 x 70 mm. - <i>Touch button</i>	
	* Ricambio di qualità equivalente <i>Matching quality spare parts</i>	

UNIVERSALE	BUS	LED
	Plafoniera incolore 12V <i>12V Clear dome lamp</i>	2.48.058.80
	Plafoniera incolore 24V <i>24V Clear dome lamp</i>	
	* Ricambio di qualità equivalente <i>Matching quality spare parts</i> 	

UNIVERSALE	LED 9 30V	
	Plafoniera 6 LED <i>6 LED dome lamp</i>	2.48.062.80
	Ø 550 mm.	
	* Ricambio di qualità equivalente <i>Matching quality spare parts</i>	

UNIVERSALE



Lampada rotante
Revolving beacom

2.47.050.00

Calotta
Cover

2.47.050.23

Fissaggio a vite | *Screw fixing*
Voltaggio 12/24V | *Voltage 12/24V*



UNIVERSALE



Lampada rotante
Revolving beacom

2.47.052.00

Calotta
Cover

2.47.050.23

Fissaggio a base magnetica | *Magnetic base fixing*
Voltaggio 12/24V | *Voltage 12/24V*



UNIVERSALE



Lampada rotante
Revolving beacom

2.47.054.00

Calotta
Cover

2.47.050.23

Fissaggio a piantone ISO | *Column fixing standard ISO*
Voltaggio 12/24V | *Voltage 12/24V*



UNIVERSALE



Lampada rotante
Revolving beacom

2.47.056.00

Calotta
Cover

2.47.050.23

Base flessibile | *Flexible base*
Voltaggio 12/24V | *Voltage 12/24V*



UNIVERSALE



Lampada flash multitens luce Xeno monolampo
Multitens flash lamp, Xenon flashing beacon single flash









2.47.058.00









Calotta
Cover

2.47.050.23

Base piana | *Flat base*
Voltaggio 10/100V | *Voltage 10/100V*

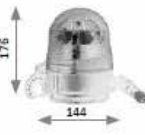

UNIVERSALE		LED 12 24V	
	Lampada rotante <i>Revolving beacom</i>		2.47.050.80
	Dynamic		
Fissaggio a vite <i>Screw fixing</i>			
UNIVERSALE		LED 12 24V	
	Lampada rotante <i>Revolving beacom</i>		2.47.052.80
	Dynamic		
Base magnetica <i>Magnetic base</i>			
UNIVERSALE		LED 12 24V	
	Lampada rotante <i>Revolving beacom</i>		2.47.054.80
	Dynamic		
Fissaggio a piantone <i>Column fixing</i>			
UNIVERSALE		LED 10 30V	
	Lampada rotante arancio <i>Orange revolving beacon</i>		2.47.098.80
	Fissaggio 3 viti <i>3 screws fixing</i> Potenza assorbita <i>Absorbed power: 11 W</i>		
* Articolo universale <i>Universal part</i>			

UNIVERSALE			LED
		<p>Lampada rotante arancio <i>Orange revolving beacon</i></p> <p>Base magnetica <i>Magnetic base</i> Cavo spiralato m 3 <i>m 3 spiral cable</i> Spinotto accendino <i>Lighter plug</i> Vtaggio <i>Voltage: 10-30 V</i></p>	<p>2.47.100.80</p>
<p>* Articolo universale Universal part</p>			
UNIVERSALE			LED
		<p>Lampada rotante arancio <i>Orange revolving beacon</i></p> <p>Base flessibile per fissaggio innesto tubolare <i>Flexible base for tube plug</i> Vtaggio <i>Voltage: 10-30 V</i> Potenza assorbita <i>Absorbed power: 11 W</i></p>	<p>2.47.102.80</p>
<p>* Articolo universale Universal part</p>			
UNIVERSALE			LED
		<p><i>Lampada rotante fissaggio a vite</i> Fissaggio 3 viti <i>3 screws fixing</i> Vtaggio <i>Voltage: 10-30 V</i> Potenza assorbita <i>Absorbed power: 11 W</i></p> <p><i>Lampada rotante base magnetica</i> Base magnetica <i>Magnetic base</i> Cavo spiralato m 3 <i>m 3 spiral cable</i> Spinotto accendino <i>Lighter plug</i> Vtaggio <i>Voltage: 10-30 V</i></p> <p><i>Lampada rotante piantone</i> Base flessibile per fissaggio innesto tubolare <i>Flexible base for tube plug</i> Vtaggio <i>Voltage: 10-30 V</i> Potenza assorbita <i>Absorbed power: 11 W</i></p> <p>Direttiva ECE R/65 - /R/10</p>	<p> 5.47.050.80</p> <p> 5.47.051.80</p> <p> 5.47.052.80</p>

UNIVERSALE

Barra 2 moduli rotanti
Bars 2 rotating modules

2.47.094.00

Fissaggio a vite | *Screwing fixing*
Voltaggio 12/24V | *Voltage 12/24V*

UNIVERSALE

Barra 2 moduli rotanti
Bars 2 rotating modules

2.47.096.00

Base magnetica | *Magnetic base*
Voltaggio 12/24V | *Voltage 12/24V*

UNIVERSALE

Lampada flash Xenon arancio
Flash lamp, Xenon flashing beacon single flash orange

2.47.060.00

Lampada flash Xenon **rossa**
Flash lamp, Xenon flashing beacon single flash red

2.47.062.00

Lampada flash Xenon **blu**
Flash lamp, Xenon flashing beacon single flash blue

2.47.064.00

Lampada flash Xenon **verde**
Flash lamp, Xenon flashing beacon single flash green

2.47.066.00

Monolampo 10/100V | *Single flash 10/100V*

UNIVERSALE
LED

Lampada rotante arancio
Orange revolving beacon

2.47.068.00

Lampada rotante **blu**
Blue revolving beacon

2.47.070.00

Fissaggio 3 viti | *3 screws fixing*
Voltaggio 10/30V | *Voltage 10/30V*







Potenza assorbita da 14W a 28W | *Power consumption from 14W to 28W*
Calotta in policarbonato trasparente | *Clear polycarbonate cover*

12 LEDs Hight Power STD



UNIVERSALE		LED
	Lampada rotante arancio <i>Orange revolving beacon</i>	2.47.072.00
	Lampada rotante blu <i>Blue revolving beacon</i>	2.47.074.00
	Base per fissaggio innesto tubolare <i>Base for fitting plug tube</i> Voltaggio 10/30V <i>Voltage 10/30V</i>	 
	Potenza assorbita da 14W a 28W <i>Power consumption from 14W to 28W</i> Calotta in policarbonato trasparente <i>Clear polycarbonate cover</i>	
	12 LEDs Hight Power STD	

UNIVERSALE		LED
 	Lampada rotante arancio <i>Orange revolving beacon</i>	2.47.076.00
	Lampada rotante blu <i>Blue revolving beacon</i>	2.47.078.00
	Base magnetica <i>Magnetic Base</i> Cavo spiralato lungo 3 metri <i>3 MT. long coiled cable</i> Spinotto accendino <i>Lighter plug</i>	 
	Attacco a tubo <i>Fitting plug tube</i> Voltaggio 10/30V <i>Voltage 10/30V</i>	
	Potenza assorbita da 14W a 28W <i>Power consumption from 14W to 28W</i> Calotta in policarbonato trasparente <i>Clear polycarbonate cover</i>	
12 LEDs Hight Power STD		

UNIVERSALE

Cavo spiralato
Coiled cable

3.49.063.00
UNIVERSALE

Perno filettato
Threaded pivots

3.49.064.00
UNIVERSALE

Spinotto accendino
Lighter-plug

3.49.066.00
UNIVERSALE

Connettore AMP 2 vie | 2 ways AMP connector
Con cavo 500 mm. e cuffia in gomma
With mm. 500 cable and rubber cap

3.49.056.50

Connettore AMP 3 vie | 3 ways AMP connector
Con cavo 500 mm. e cuffia in gomma
With mm. 500 cable and rubber cap

3.49.057.50
UNIVERSALE

Segnalatore acustico universale - 10/30 Vcc
Universal acoustic signal - 10/30 Vcc

3.49.052.00

Segnalatore acustico universale - 30/120 CC
Universal acoustic signal - 30/120 CC

3.49.054.00

UNIVERSALE



Portalampane di metallo per lampada BA9S
Metal bulb holder for BA9S bulb

3.49.075.00

Cavo 200 metri | *200 mt. cable*

UNIVERSALE



Connettore per fanali posteriori Aspock
Connector for rear lamps



3.49.094.00



Connettore per fanali posteriori Aspock
Connector for rear lamps



3.49.095.00

UNIVERSALE



Corpetto omologato arancio EN471 classe 2
Class 2 EN471 approved orange vest

4.46.79.57

UNIVERSALE



Raccordo (ghiera M45x1,5)
Nipple (plastic ring M45x1.5)

6.49.055.00

UNIVERSALE



Portalampane per H1
H1 bulb holder

3.49.092.00

* **Articolo universale | Universal part**

UNIVERSALE

Smorzatore vibrazioni
Silent block

3.49.050.00

UNIVERSALE

Segnalatore acustico universale - 9/33 Vcc | 70 DB
Universal acoustic signal - 9/33 Vcc | 70 DB

3.49.084.00

Segnalatore acustico universale - 9/33 Vcc | 88 DB
Universal acoustic signal - 9/33 Vcc | 88 DB

3.49.086.00

UNIVERSALE

Connettore AMP 2 vie | 2 ways AMP connector
Cuffia in gomma | *Rubber cap*

3.49.056.00

Connettore AMP 3 vie | 3 ways AMP connector
Cuffia in gomma | *Rubber cap*

3.49.057.00

Kit con 2 pezzi | *Kit with 2 female connectors*

UNIVERSALE

Connettore a 1 scanalatura
Connector at 1 groove

3.49.073.50

IVECO | UNIVERSALE

Connettore femmina 10 vie
10 ways female connector

3.49.058.00

Kit con 2 pezzi | *Kit with 2 female connectors*

IVECO | UNIVERSALE



Connettore femmina 3 vie
3 ways female connector

3.49.060.00

Kit con 2 pezzi | Kit with 2 female connectors

IVECO | UNIVERSALE



Connettore
Connector

3.49.070.00



Connettore
Connector

3.49.071.00

UNIVERSALE



Connettore
Connector

3.49.080.00

Per fanale | For lamp 2.44.068.00 - 2.44.069.00

UNIVERSALE



Raccordo (Ghiera M41x1,5)
Nipple (Plastic ring M41x1,5)

6.49.050.00

UNIVERSALE



Raccordo (Ghiera M42x1,5)
Nipple (Plastic ring M42x1,5)

6.49.052.00



Raccordo (Ghiera M28x1,5)
Nipple (Plastic ring M28x1,5)

6.49.054.00

UNIVERSALE

 Faro orientabile H3
Adjustable headlamp h3
3.47.050.00

95x95 mm.

UNIVERSALE

 Faro orientabile H3
Adjustable headlamp h3
3.47.052.00

 Con interruttore | *With switch* - 170x100 mm.

UNIVERSALE

 Faro orientabile H3
Adjustable headlamp h3
3.47.054.00

 Con interruttore | *With switch* - 156x110 mm.

UNIVERSALE
6 LED

 Faro lavoro 1000 lumen
Working lamp
3.47.056.00

 Voltaggio 10/60V | *Voltage 10/60V*

 Intensità 1,8 A - 12V | *Current 1,8 A - 12V*

 Inversione di polarità protetto | *Polarity inversion protection*

 Temperatura di uso -40° / +65° C | *Working temperature -40° / +65° C*

 Distribuzione ottica spot lavoro 40° x 25° | *Optical distribution spot work 40°x25°*

UNIVERSALE



Kit telecamera digitale / Kit digital camera

12/24 Multi schermi a colori 7 Pollici
 Trasmissione senza fili 2GHz
 Collegamento fino a 4 telecamere
 Registrazione in tempo reale
 Supporto SD / Camera con microfono
 Visione notturna

5.47.200.00

12/24 Multi color screen 7 inches
 Wireless transmission 2GHz
 Connection up to 4 cameras
 Real time recording
 SD support / Camera with microphone
 Night vision

UNIVERSALE



Telecamera supplementare
 Additional camera

5.47.200.50

UNIVERSALE











Porta Estintore 6 Kg / 6kg Holder fire extinguisher

Con cinghie nylon / With nylon straps

635x282x227

5.47.100.00

ECE 70.01 CLASSE 3	PANNELLI PER MOTRICE		ECE 70.01 CLASSE 3	PANNELLI PER RIMORCHIO	
	Supporto in alluminio 565x130x1,0 mm.	4.46.40.01		Adesivo 565x130 mm.	4.46.40.05
Kit 2 pezzi pellicola 3M		Kit 2 pezzi pellicola 3M			
ECE 70.01 CLASSE 3	PANNELLI PER MOTRICE		ECE 104 CLASSE 3	NASTRO SEGNALEZIONE SAGOMA GIALLO superfici rigide	
	Adesivo 565x130 mm.	4.46.40.02		55 mm. x 50 m	4.46.71.01
Kit 2 pezzi pellicola 3M					
CLASSE 3	PANNELLI PER VEICOLI AGRARI		ECE 104 CLASSE 3	NASTRO SEGNALEZIONE SAGOMA ROSSO superfici rigide	
	Supporto in alluminio 564x282 mm.	4.46.40.51		55 mm. x 50 m	4.46.71.03
Kit 2 pezzi pellicola 3M					
ECE 70.01 CLASSE 3	PANNELLI PER RIMORCHIO		ECE 104 CLASSE 3	NASTRO SEGNALEZIONE SAGOMA BIANCO superfici rigide	
	Supporto in alluminio 565x130x1,0 mm.	4.46.40.04		55 mm. x 50 m	4.46.71.05
Kit 2 pezzi pellicola 3M					

ECE 104 CLASSE 3	NASTRO SEGNALEZIONE SAGOMA GIALLO superfici telonate		55 mm. x 50 m	4.46.71.07
-----------------------------	---	---	---------------	-------------------

ECE 104 CLASSE 3	NASTRO SEGNALEZIONE SAGOMA ROSSO superfici telonate versione segmentata		51 mm. x 50 m	4.46.71.15
-----------------------------	--	--	---------------	-------------------

ECE 104 CLASSE 3	NASTRO SEGNALEZIONE SAGOMA ROSSO superfici telonate		55 mm. x 50 m	4.46.71.09
-----------------------------	--	---	---------------	-------------------

ECE 104 CLASSE 3	NASTRO SEGNALEZIONE SAGOMA BIANCO superfici telonate versione segmentata		51 mm. x 50 m	4.46.71.17
-----------------------------	---	--	---------------	-------------------

ECE 104 CLASSE 3	NASTRO SEGNALEZIONE SAGOMA BIANCO superfici telonate		55 mm. x 50 m	4.46.71.11
-----------------------------	---	---	---------------	-------------------

CLASSE 2	LIMITE VELOCITÀ 15 KM		Adesivo Ø 200 mm.	4.46.50.15
Kit 1 pezzo - confezione 8 pezzi				

ECE 104 CLASSE 3	NASTRO SEGNALEZIONE SAGOMA BIANCO superfici telonate versione segmentata		51 mm. x 50 m	4.46.71.13
-----------------------------	---	---	---------------	-------------------

CLASSE 2	LIMITE VELOCITÀ 40 KM		Adesivo Ø 200 mm.	4.46.50.40
Kit 1 pezzo - confezione 8 pezzi				

CLASSE 2	LIMITE VELOCITÀ 60 KM	
	Adesivo Ø 200 mm.	4.46.50.60
	Kit 1 pezzo - confezione 8 pezzi	

CLASSE 2	LIMITE VELOCITÀ 70 KM	
	Adesivo Ø 200 mm.	4.46.50.70
	Kit 1 pezzo - confezione 8 pezzi	

CLASSE 2	LIMITE VELOCITÀ 80 KM	
	Adesivo Ø 200 mm.	4.46.50.80
	Kit 1 pezzo - confezione 8 pezzi	

CLASSE 2	LIMITE VELOCITÀ 90 KM	
	Adesivo Ø 200 mm.	4.46.50.90
	Kit 1 pezzo - confezione 8 pezzi	

CLASSE 2	LIMITE VELOCITÀ 100 KM	
	Adesivo Ø 200 mm.	4.46.51.00
	Kit 1 pezzo - confezione 8 pezzi	

DISPOSITIVO PIANO - CLASSE 2	TRASPORTO MERCI PERICOLOSE ADR	
	Lamiera zincata 400 x 300 mm.	4.46.60.01
	Confezione 2 pezzi	

PIEGHEVOLE RIDOTTO CLASSE 1	TRASPORTO MERCI PERICOLOSE ADR	
	Lamiera zincata 300 x 120 mm.	4.46.60.02
	Confezione 2 pezzi	

PETROLIFERI CLASSE 1	TRASPORTO MERCI PERICOLOSE ADR	
	Lamiera zincata 400 x 300 mm.	4.46.60.03
	Confezione 2 pezzi	

PORTA PANNELLO CON 2 TURNIQUET	TRASPORTO MERCI PERICOLOSE ADR	
	Acciaio INOX 400 x 300 mm.	4.46.60.04
	A.D.R. 2009 per evitare il distacco del dispositivo in caso di ribaltamento del mezzo	

CLASSE 1	SEGNALATORE SOSTANZE ESPLOSIVE	
	Divisione 1.1 - 1.2 - 1.3 300 x 300 mm. adesivo PVC	4.46.60.05
	Confezione 2 pezzi	

CLASSE 1	SEGNALATORE SOSTANZE ESPLOSIVE	
	Divisione 1.4 300 x 300 mm. adesivo PVC	4.46.60.06
	Confezione 2 pezzi	

CLASSE 2	PANNELLO PER CARICHI SPORGENTI	
	Alluminio 500 x 500 x 1,0 mm.	4.46.70.01
	Confezione 2 pezzi	

CAVO SPINE ABS-EBS	N. 7 POLI 24V	
	<ul style="list-style-type: none"> ▶ Buone proprietà di riavvolgimento. ▶ Sistema di trasmissione dati separato per evitare interferenze elettriche. ▶ Conforme ai regolamenti A.D.R.. ▶ Manicotti anti piegatura. ▶ Il cavo EBS funzione anche come ABS. <p>Materiale:</p> <ul style="list-style-type: none"> ▶ Poliuretano trattato per resistere al calore e alla luce. <p>Utilizzo:</p> <ul style="list-style-type: none"> ▶ Sistema di frenatura elettronico per motrici e rimorchi. ▶ Cavo 7P 3x1,5 mm.² + 2x4,0 mm.² + 2x1,0 mm.² Ø spirale 55 mm. ▶ Massima estensione 3,50 m. 	4.42.743.00
<p>Normativa: ISO 4091 - ISO 6722 - ISO 7638</p>		

ADATTATORE CAVO SPIRALATO	N. 15 POLI 24V 2 SPINE FISSE 7 POLI	
 	<ul style="list-style-type: none"> ▶ Esclusivo sistema di antidisinserimento della spina incorporato. ▶ Ultimo ritrovato della tecnologia "Thin Wall". ▶ Connettori ISO. ▶ Conforme ai regolamenti A.D.R.. <p>Materiale:</p> <ul style="list-style-type: none"> ▶ Poliuretano trattato per resistere al calore e alla luce. ▶ Guaina a consistenza morbida. <p>Utilizzo:</p> <ul style="list-style-type: none"> ▶ Spina a 15 poli per motrici e rimorchi. ▶ Cavo 7P 6x1,0 mm.² + 1x2,5 mm.² Ø spirale 40 mm. ▶ Massima estensione 4,00 m. 	4.42.956.00
<p>Normativa: ISO 12098</p>		

CAVO SPIRALATO	N. 15 POLI 24V	
	<ul style="list-style-type: none"> ▶ Esclusivo sistema di antidisinserimento della spina incorporato. ▶ Capacità antiattorcigliamento migliorate ▶ Connettori ISO. ▶ Conforme ai regolamenti A.D.R.. <p>Materiale:</p> <ul style="list-style-type: none"> ▶ Materiale trattato per resistere al calore e alla luce. ▶ Guaina a consistenza morbida. <p>Utilizzo:</p> <ul style="list-style-type: none"> ▶ Adattatore per motrici e rimorchi. ▶ Cavo 15P 12x1,5 mm.² + 3x2,5 mm.² Ø spirale 40 mm. ▶ Massima estensione 4,00 m. 	4.42.842.00
<p>Normativa: ISO 4091 - ISO 6722 - ISO 7638</p>		

**CAVO SPIRALATO
CON SPINE****N. 7 POLI TIPO N**

- ▶ Massa di ritorno
- ▶ Luce di posizione sinistra, luci di ingombro, illuminazione targa
- ▶ Indicatore di direzione sinistra
- ▶ Luci stop
- ▶ Indicatore di direzione destra
- ▶ Luce di posizione destra, luce ingombro, illuminazione targa
- ▶ Controllo di frenatura rimorchio
- ▶ Cavo 7P 6x1,0 mm.² + 1x2,5 mm.² Ø spirale 40 mm.
- ▶ Massima estensione 3,50 m

4.42.056.07**Normativa:** ISO 1185**CAVO SPIRALATO
CON SPINE****N. 7 POLI TIPO S - 24V**

- ▶ Massa di ritorno
- ▶ Nessuna applicazione
- ▶ Luci retromarcia
- ▶ Positivo di alimentazione diretto da batteria
- ▶ Sensore con ritorno e massa
- ▶ Positivo di alimentazione sotto chiave avviamento
- ▶ Luci retro-nebbia
- ▶ Cavo 7P 6x1,0 mm.² + 1x2,5 mm.² Ø spirale 40 mm.
- ▶ Massima estensione 3,50 m

4.42.056.08**Normativa:** ISO 3731**ADATTATORE COMPATTO
DA SPINA****N. 15 POLI - 24V
A 2 PRESE 7 POLI**

Normativa: spina 15 poli ISO 12098
spina 7 poli N ISO 1185
spina 7 poli N ISO 3731

4.42.130.00

SPIRALE ARIA	FLEXI AIR	
	<ul style="list-style-type: none"> ▶ Spirale aria compatta e con elevata flessibilità ▶ Pressione di scoppio minima 40 Bar ▶ Diametro interno 50 mm. ▶ Realizzato secondo le specifiche DIN 74323 e ISO 7375 ▶ Soluzione compatta per utilizzo generico <p>Normativa: ISO 7375 testati fino a 10.000 stiramenti</p>	4.55.324.11

SPIRALE ARIA	FLEXI AIR	
	<ul style="list-style-type: none"> ▶ Spirale aria compatta e con elevata flessibilità ▶ Pressione di scoppio minima 40 Bar ▶ Diametro interno 50 mm. ▶ Realizzato secondo le specifiche DIN 74323 e ISO 7375 ▶ Soluzione compatta per utilizzo generico <p>Normativa: ISO 7375 testati fino a 10.000 stiramenti</p>	4.55.324.22

TESTINA ACCOPPIAMENTO		
	AUTOMATICA M 16x1,5 mm. gialla	4.14.000.03
	AUTOMATICA M 16x1,5 mm. rossa	4.14.000.04

TESTINA ACCOPPIAMENTO		
	STANDARD M 16x1,5 mm. gialla	4.14.000.07
	STANDARD M 16x1,5 mm. rossa	4.14.000.08

mirrors

RETROVISORI

BOBCAT | LIEBHERR
TRATTORI E MEZZI MOVIMENTO TERRA

Coppa nera

68.5.752.025

371x197 mm.

FIAT
DUCATO

06→



Manuale con braccio corto

67.2301

Manuale con braccio corto

67.2302

Manuale con sonda braccio corto

67.2307

Elettrico riscaldato braccio corto

67.2309

Elettrico riscaldato braccio corto DX

67.2310

Elettrico riscaldato braccio corto con sonda

67.2323

 Elettrico riscaldato braccio corto con sonda
abbattimento elettrico

67.2329

 Elettrico riscaldato braccio corto con sonda
abbattimento elettrico

67.2328

Elettrico riscaldato braccio medio con sonda

67.2349

Elettrico riscaldato braccio medio

67.2347

Elettrico riscaldato braccio medio

67.2348

Elettrico riscaldato braccio lungo con sonda

67.2369

Elettrico riscaldato braccio lungo

67.2367

Elettrico riscaldato braccio lungo

67.2368

Manuale con braccio lungo

67.2358

Manuale con braccio lungo

67.2357

Vetro principale con piastra

67.0658

Vetro principale con piastra

67.0657

Vetro riscaldato principale con piastra

67.0660

Vetro riscaldato principale con piastra

67.0659

Vetro grandangolare con piastra

67.0662

Vetro grandangolare con piastra

67.0661

Vetro riscaldato grandangolare con piastra

67.0664

Vetro riscaldato grandangolare con piastra

67.0663

FIAT	DUCATO			
	99→06	Retrovisore manuale braccio corto <i>Manual mirror short arm</i>	➔	67.1142
		Retrovisore manuale braccio corto <i>Manual mirror short arm</i>	➜	67.1141

FIAT	DUCATO			
	99→06	Retrovisore manuale braccio lungo <i>Manual mirror long arm</i>	➔	67.1146
		Retrovisore manuale braccio lungo <i>Manual mirror long arm</i>	➜	67.1145

FIAT	DUCATO			
	99→06	Retrovisore elettrico riscaldato braccio corto <i>Electrical heated mirror short arm</i>	➔	67.1144
		Retrovisore elettrico riscaldato braccio corto <i>Electrical heated mirror short arm</i>	➜	67.1143

FIAT	DUCATO			
	99→06	Retrovisore elettrico riscaldato braccio lungo <i>Electrical heated mirror long arm</i>	➔	67.1148
		Retrovisore elettrico riscaldato braccio lungo <i>Electrical heated mirror long arm</i>	➜	67.1147

FIAT	DUCATO CHASIS 2350			
	99→06	Retrovisore elettrico riscaldato braccio lungo <i>Electrical heated mirror long arm</i>	➔	67.1888
		Retrovisore elettrico riscaldato braccio lungo <i>Electrical heated mirror long arm</i>	➜	67.1887

FIAT		DUCATO		
	99→06	Piastra con vetro riscaldato <i>Plate with heated glass</i>	→	67.0384
		Piastra con vetro riscaldato <i>Plate with heated glass</i>	←	67.0383

FIAT		DUCATO		
	99→06	Piastra con vetro riscaldato <i>Plate with heated glass</i>	→	67.0400
		Piastra con vetro riscaldato <i>Plate with heated glass</i>	←	67.0399

FIAT		FIORINO BIPPER NEMO		
 	14→	Retrovisore manuale riscaldato <i>Manual heated mirror</i>	→	67.1032.50
		Retrovisore manuale riscaldato <i>Manual heated mirror</i>	←	67.1033.50
		Retrovisore manuale riscaldato con sonda <i>Manual heated mirror with sonde</i>	→	67.1034.51
		Retrovisore manuale riscaldato <i>Manual heated mirror</i>	→	67.1032.01
		Retrovisore manuale riscaldato <i>Manual heated mirror</i>	←	67.1033.01

IVECO		AUTOBUS URBANI		
	00→06	Coppa nera termica 24V	→ ←	68.7.600.025
		Coppa nera termica 12V	→ ←	68.7.601.025
		370x210 mm.		

IVECO		DAILY	
		Manuale con sonda braccio corto	← 67.1207
		Manuale con braccio corto	← 67.1067
		Manuale con sonda corto	→ 67.1068
		Manuale riscaldato braccio corto	← 67.1209
		Manuale riscaldato braccio corto	→ 67.1210
		Elettrico riscaldato braccio corto con sonda	← 67.1213
	00→05	Elettrico riscaldato braccio corto	← 67.1073
		Elettrico riscaldato braccio corto	→ 67.1074
		Elettrico riscaldato braccio medio	← 67.1075
		Elettrico riscaldato braccio medio	→ 67.1076
		Elettrico riscaldato braccio lungo con sonda	← 67.1227
	Elettrico riscaldato braccio lungo	← 67.1077	
	Elettrico riscaldato braccio lungo	→ 67.1078	

IVECO		DAILY III	
		Retrovisore completo corto manuale con freccia nero	→ 68.31.802
		Retrovisore completo corto manuale con freccia nero	← 68.31.800
		Retrovisore completo corto manuale con freccia e con antenna nero	→ 68.31.815
		Retrovisore completo corto elettrico termico con freccia nero	→ 68.31.810
	06→11	Retrovisore completo corto elettrico termico con freccia nero	← 68.31.809
		Retrovisore completo corto elettrico termico con freccia e antenna nero	← 68.31.806
		Retrovisore completo corto elettrico termico con freccia e sonda nero	← 68.31.812
		Retrovisore completo lungo elettrico termico con antenna nero	→ 68.31.825
	Retrovisore completo lungo elettrico termico con sonda nero	← 68.31.823	





IVECO		DAILY III	
	06→11	Vetro principale con piastra termica 12V	➔ 68.7.417.V44Q
		Vetro principale con piastra termica 12V	➜ 68.7.417.V45Q
		Vetro grandangolare con piastra termica 12V	➔ 68.7.418.V44Q
		Vetro grandangolare con piastra termica 12V	➜ 68.7.418.V45Q

IVECO		DAILY 2000	
	99→06	Vetrino grandangolare	➔ ➜ 68.5.401.045

IVECO		DAILY 2000	
	00→05	Retrovisore manuale riscaldato braccio medio <i>Manual heated mirror medium arm</i>	➔ 67.1070
		Retrovisore manuale riscaldato braccio medio <i>Manual heated mirror medium arm</i>	➜ 67.1069

IVECO		EUROCARGO EUROSTAR STRALIS 1 ⁵	
	93-05→	Calotta - modello Vitaloni <i>Cover - Vitaloni model</i>	➔ ➜ 68.9.527.012

IVECO		EUROCARGO EUROSTAR STRALIS 1 ⁵	
	93-05→	Calotta - modello Donnely <i>Cover - Donnely model</i>	➔ ➜ 68.9.526.012

IVECO	EUROCARGO STRALIS TRAKKER TECTOR		
	06→	Grandangolare Specchio completo manuale	68.5.622.000
IVECO	EUROCARGO STRALIS TRAKKER TECTOR		
	06→	Vetro principale con piastra termica 24V 376x198 mm.	68.7.524.V45
IVECO	EUROCARGO STRALIS TRAKKER TECTOR		
	06→	Vetro grandangolare con piastra riscaldata 24V 210x196 mm.	68.7.525.V45
IVECO	EUROCARGO STRALIS 1ª SERIE EUROSTAR		
	00→06	Specchio completo grigio Specchio completo grigio termico 24V Grandangolare	68.5.631.001 68.7.631.000

IVECO		EUROCARGO STRALIS EUROSTAR	
	93→06	Coppa grigio scuro (IC289) termica 24V	68.9.523.V25
		Vetro con piastra termica 24V 442x197 mm. attacco a ghiera	68.7.523.V45
		Calotta grigio scuro (IC289) 429x153 mm.	68.9.523.012
		Calotta grigio chiaro (IC193) 429x153 mm.	68.9.525.012
		455x219 mm.	

IVECO		EUROSTAR EUROTECH TRAKKER STRALIS EUROTRAKKER	
	93→06	Coppa grigio scuro (IC289) termica 24V	↔ 68.9.522.V25
		Vetro con piastra termica 24V 340x97 mm. attacco a ghiera	68.7.522.V45
		Vetro con piastra termica 24V 340x97 mm. attacco a molla	68.7.521.V45
		Calotta grigio scuro (IC289) 328x153 mm.	68.9.522.012
		363x219 mm.	

IVECO		EUROTECH EUROSTAR EUROTRAKKER	
	93→	Retrovisore grandangolo elettrico riscaldato <i>Electrical heated wide mirror</i>	68.6.622.00
		Vetro con piastra (modello Donnely) Glass with plate (Donnely model)	68.7.517.020
		Vetro con piastra riscaldata (modello Donnely) Heated glass with plate (Donnely model)	68.7.517.045
		Modello Vitaloni/Donnely <i>Vitaloni/Donnely model</i>	











IVECO		STRALIS EUROCARGO	
	06→	Calotta	→ 70.1000.20
		Calotta	← 70.1001.20

IVECO		STRALIS EUROCARGO		
	06→	Calotta	→	70.1000.30
		Calotta	←	70.1001.30

IVECO		STRALIS		
	07→	Guardaruota manuale riscaldato		67.0103

IVECO		STRALIS		
	07→	Guarda avanti manuale riscaldato	←	67.0107

IVECO		190 TURBO AUTOBUS STARBUS MAGIRUS DEUTZ		
		Coppa nera manuale	← →	68.5.796.025
		Coppa grigia manuale	← →	68.5.789.025
		Coppa nera termica 24V	← →	68.7.796.025
		Resistenza 24V		68.7.750.035
		439x209 mm.		

IVECO		OM 170/35 - 159/20 - 110/190 - FIAT 170NT35 130NC - 150NR - AUTOBUS 309 - 409 - 370	
  resistenza	Coppa grigia manuale	 	68.5.793.025
	Coppa nera manuale	 	68.5.791.025
	Coppa nera termica 24V	 	68.7.792.025
	Coppa grigia termica 24V	 	68.7.793.025
	Resistenza 24V universale (310x155 mm.)		68.7.750.035
	459x209 mm.		

IVECO		OM50 - 50NC - 60NC - 60.10 - 79.13	
	Coppa nera manuale	 	68.5.675.025
	Vetro di ricambio 336x157 m		68.5.675.045
	346x162 mm.		

MANITOU CLASS GOLDONI JOHN DEERE		TRATTORI E MEZZI MOVIMENTO TERRA	
	Coppa ricambio nera	 	68.6.152.025
	245x155 mm.		

MANITOU CLASS GOLDONI JOHN DEERE		TRATTORI E MEZZI MOVIMENTO TERRA	
	Coppa nera	 	68.5.753.025
	360x160 mm.		

SAME | DEUTZ | FAHR
MASSEY FERGUSSON
ANTONIO CARRARO
KUBOTA | JOHN DEERE
LANDINI

TRATTORI
E MEZZI MOVIMENTO TERRA



Coppa nera attacco D. 16-18-20



68.6.418.025

246x182 mm.

MERCEDES

LK08



Coppa nera manuale



68.5.200.025

305x183 mm.

rear view mirrors metallized covers

COPPE RETROVISORI METALLIZZATE

FIAT	DOBLO		05→10
	<p>Kit calotta cromata <i>Chromed cover kit</i></p> 	67.1100	
FIAT	QUBO - FIORINO - NEMO		08→
	<p>Kit calotta cromata <i>Chromed cover kit</i></p> 	67.1200	
	<p>Kit cromato per fanale posteriore <i>Chromed kit for rear lamp</i></p> 	67.1217	
FIAT	DOBLO		10→
	<p>Kit calotta cromata <i>Chromed cover kit</i></p> 	67.1300	
	<p>Kit cromato per fanale posteriore <i>Chromed kit for rear lamp</i></p> 	67.1317	
FIAT	DUCATO		06→
	<p>Kit calotta cromata <i>Chromed cover kit</i></p> 	67.1400	
	<p>Kit cromato per fanale posteriore <i>Chromed kit for rear lamp</i></p> 	67.1417	

FIAT	DUCATO		06→
	<p>Kit Cromato per maniglie <i>Chromed kit for handles</i></p>		67.1490
FORD	CONNECT		09→
	<p>Kit calotta cromata (02→09) <i>Chromed cover kit</i></p>		67.1550
	<p>Kit calotta cromata <i>Chromed cover kit</i></p>		67.1500
	<p>Kit cromato per fanale posteriore <i>Chromed kit for rear lamp</i></p>		67.1517
FORD	COURIER		14→
	<p>Kit calotta cromata <i>Chromed cover kit</i></p>		67.2100
	<p>Kit cromato per fanale posteriore <i>Chromed kit for rear lamp</i></p>		67.2117
FORD	TRANSIT		14→
	<p>Kit calotta cromata <i>Chromed cover kit</i></p>		67.1650

FORD	TRANSIT	14→
	<p>Kit cromato per fanale posteriore <i>Chromed kit for rear lamp</i></p> 	67.1617
MERCEDES	SPRINTER	→06
	<p>Kit calotta cromata 98/06 <i>Chromed cover kit</i></p> 	67.1700
	<p>Kit calotta cromata 06→ <i>Chromed cover kit</i></p> 	67.1800
MERCEDES	VITO	98→10
	<p>Kit calotta cromata 98/06 <i>Chromed cover kit</i></p> 	67.1900
	<p>Kit calotta cromata 06→ <i>Chromed cover kit</i></p> 	67.2000

code index

INDICE PER CODICE

INDICE PER CODICE *CODE INDEX*

CODICE/CODE	PAG.	CODICE/CODE	PAG.	CODICE/CODE	PAG.	CODICE/CODE	PAG.
1.01.050.00	7	1.02.125.00	18	1.04.062.10	43	1.04.120.00	61
1.01.050.24	7	1.02.126.00	18	1.04.063.00	43	1.04.121.00	61
1.01.050.25	7	1.02.127.00	18	1.04.063.10	43	1.04.122.00	61
1.01.052.00	10	1.02.130.12	27	1.04.064.00	44	1.04.124.00	61
1.01.053.00	10	1.02.132.12	26	1.04.065.00	44	1.04.125.00	61
1.01.054.00	8	1.02.134.12	20	1.04.066.00	47	1.04.126.00	59
1.01.054.18	8	1.02.136.00	23	1.04.067.00	47	1.04.127.00	59
1.01.055.00	8	1.02.137.00	23	1.04.068.00	47	1.04.128.00	60
1.02.052.00	18	1.02.144.12	23	1.04.069.00	47	1.04.129.00	60
1.02.054.12	18	1.02.146.12	20	1.04.070.00	47	1.04.130.06	59
1.02.055.12	18	1.02.148.00	26	1.04.070.10	47	1.04.131.06	59
1.02.056.00	18	1.02.150.00	28	1.04.071.00	47	1.04.134.00	32
1.02.057.00	18	1.02.151.00	28	1.04.071.10	47	1.04.135.00	32
1.02.058.12	18	1.02.154.00	27	1.04.074.10	57	1.04.136.00	32
1.02.060.00	18	1.02.155.00	27	1.04.074.18	57	1.04.137.00	32
1.02.064.00	25	1.02.156.00	28	1.04.075.10	57	1.04.138.00	32
1.02.066.00	22	1.02.157.00	28	1.04.075.18	57	1.04.139.00	32
1.02.066.11	22	1.02.158.00	27	1.04.078.10	57	1.04.140.00	33
1.02.068.00	19	1.02.159.00	27	1.04.078.18	57	1.04.141.00	33
1.02.070.00	19	1.02.160.00	18	1.04.079.10	57	1.04.142.00	40
1.02.074.00	20	1.02.161.00	18	1.04.079.18	57	1.04.143.00	40
1.02.076.00	20	1.02.164.00	25	1.04.080.10	55	1.04.144.00	30
1.02.078.00	21	1.02.165.00	25	1.04.080.18	55	1.04.146.00	31
1.02.080.12	20	1.02.166.00	25	1.04.081.10	55	1.04.147.00	31
1.02.082.00	20	1.02.167.00	25	1.04.081.18	55	1.04.148.00	65
1.02.084.00	20	1.02.168.00	22	1.04.082.00	37	1.04.149.00	65
1.02.086.00	21	1.02.169.00	22	1.04.090.00	48	1.04.150.00	42
1.02.088.00	21	1.02.170.12	27	1.04.092.00	57	1.04.151.00	42
1.02.090.00	21	1.02.171.12	27	1.04.096.06	55	1.04.152.00	42
1.02.092.00	21	1.02.172.12	26	1.04.097.06	55	1.04.153.00	42
1.02.094.00	21	1.04.050.00	29	1.04.102.00	45	1.04.154.00	66
1.02.096.12	21	1.04.051.00	29	1.04.106.00	56	1.04.155.00	66
1.02.098.00	20	1.04.052.00	29	1.04.107.00	56	1.04.156.00	66
1.02.100.12	27	1.04.053.00	29	1.04.108.00	56	1.04.157.00	66
1.02.102.12	25	1.04.054.00	29	1.04.109.00	56	1.04.158.00	66
1.02.110.12	23	1.04.055.00	29	1.04.110.00	56	1.04.159.00	66
1.02.112.00	25	1.04.056.10	39	1.04.112.00	45	1.04.160.00	67
1.02.113.00	25	1.04.056.18	39	1.04.113.00	45	1.04.161.00	67
1.02.116.12	26	1.04.057.10	39	1.04.114.00	69	1.04.162.00	67
1.02.118.12	26	1.04.057.18	39	1.04.115.00	69	1.04.163.00	67
1.02.119.12	26	1.04.060.10	39	1.04.116.00	56	1.04.166.00	60
1.02.120.12	27	1.04.060.18	39	1.04.118.00	60	1.04.167.00	60
1.02.122.00	27	1.04.061.10	39	1.04.118.17	61	1.04.170.00	60
1.02.123.00	27	1.04.061.18	39	1.04.119.00	60	1.04.171.00	60
1.02.124.00	18	1.04.062.00	43	1.04.119.17	61	1.04.172.06	60

CODICE/CODE	PAG.	CODICE/CODE	PAG.	CODICE/CODE	PAG.	CODICE/CODE	PAG.
1.04.173.06	60	1.04.223.00	59	1.06.067.00	76	1.42.069.00	103
1.04.174.00	61	1.04.224.00	58	1.06.068.00	76	1.42.070.00	104
1.04.175.00	61	1.04.225.00	58	1.06.069.00	76	1.42.072.00	104
1.04.176.00	62	1.04.226.00	58	1.06.070.00	76	1.42.074.00	105
1.04.177.00	62	1.04.227.00	58	1.06.070.01	76	1.42.074.24	105
1.04.178.00	62	1.05.050.00	70	1.06.071.00	76	1.42.075.00	105
1.04.180.00	62	1.05.052.00	70	1.06.074.00	75	1.42.075.24	105
1.04.180.17	63	1.05.054.00	70	1.06.075.00	75	1.42.076.00	105
1.04.181.00	62	1.05.056.00	70	1.06.076.00	75	1.42.076.11	105
1.04.181.17	63	1.05.058.00	73	1.06.077.00	75	1.42.077.00	105
1.04.182.06	62	1.05.060.00	73	1.06.078.00	75	1.42.077.11	105
1.04.183.06	62	1.05.062.00	71	1.06.079.00	75	1.43.050.00	112
1.04.184.00	65	1.05.064.00	71	1.06.080.00	75	1.43.051.00	112
1.04.185.00	65	1.05.068.00	71	1.06.081.00	75	1.43.052.00	113
1.04.186.00	41	1.05.070.00	72	1.06.084.00	75	1.43.053.00	113
1.04.187.00	41	1.05.072.80	70	1.06.085.00	75	1.43.054.00	113
1.04.188.00	41	1.05.074.00	71	1.06.086.00	76	1.43.056.00	113
1.04.189.00	41	1.05.080.80	70	1.06.087.00	76	1.43.058.00	112
1.04.190.06	41	1.05.084.00	72	1.06.088.00	75	1.43.060.00	112
1.04.191.06	41	1.05.086.00	73	1.06.089.00	75	1.43.064.00	114
1.04.192.06	42	1.05.090.12	73	1.06.090.00	76	1.43.068.00	113
1.04.193.06	42	1.05.092.00	71	1.06.091.00	76	1.43.069.00	113
1.04.194.00	55	1.05.092.18	73	1.06.092.00	76	1.43.070.00	115
1.04.195.00	55	1.05.096.00	72	1.06.093.00	76	1.43.071.00	115
1.04.198.00	41	1.05.098.00	73	1.08.052.00	78	1.43.072.00	114
1.04.199.00	41	1.05.100.00	73	1.08.056.00	78	1.43.073.00	114
1.04.200.06	42	1.05.102.12	72	1.08.058.00	78	1.43.074.00	114
1.04.201.06	42	1.05.104.00	70	1.08.068.00	77	1.43.075.00	114
1.04.202.00	31	1.05.106.00	71	1.08.070.00	78	1.43.076.00	113
1.04.203.00	31	1.05.110.00	74	1.09.050.00	28	1.43.077.00	113
1.04.204.00	31	1.05.112.00	70	1.09.051.00	28	1.43.078.00	114
1.04.205.00	31	1.05.114.00	72	1.09.052.00	110	1.43.079.00	114
1.04.206.00	32	1.05.116.12	73	1.41.052.00	92	1.43.080.80	114
1.04.206.17	32	1.05.116.19	73	1.41.052.24	92	1.43.081.80	114
1.04.207.00	32	1.05.118.00	71	1.41.053.00	92	1.43.082.80	130
1.04.207.17	32	1.05.120.00	70	1.41.053.24	92	1.43.082.82	130
1.04.208.00	49	1.05.122.00	74	1.42.050.00	100	1.43.082.83	130
1.04.209.00	49	1.05.124.00	74	1.42.052.00	101	1.43.083.80	130
1.04.210.00	49	1.05.126.00	74	1.42.054.00	101	1.43.084.80	130
1.04.211.00	49	1.06.052.00	75	1.42.058.11	101	1.44.050.00	139
1.04.212.00	49	1.06.053.00	75	1.42.060.00	103	1.44.050.20	139
1.04.213.00	49	1.06.054.00	75	1.42.062.00	103	1.44.050.28	144
1.04.214.00	39	1.06.055.00	75	1.42.063.00	103	1.44.051.00	139
1.04.216.00	38	1.06.058.00	75	1.42.064.00	103	1.44.051.20	139
1.04.218.00	44	1.06.059.00	75	1.42.065.00	103	1.44.051.29	144
1.04.220.00	59	1.06.064.00	76	1.42.066.00	103	1.44.052.00	150
1.04.221.00	59	1.06.065.00	76	1.42.067.00	103	1.44.052.20	145
1.04.222.00	59	1.06.066.00	76	1.42.068.00	103	1.44.053.00	150

CODICE/CODE	PAG.	CODICE/CODE	PAG.	CODICE/CODE	PAG.	CODICE/CODE	PAG.
1.44.053.20	145	1.48.074.00	201	2.01.095.00	11	2.01.143.12	16
1.44.055.01	150	2.01.050.00	9	2.01.096.00	11	2.02.052.00	21
1.44.056.00	139	2.01.051.00	9	2.01.097.00	11	2.02.054.00	25
1.44.057.00	139	2.01.052.00	9	2.01.098.00	11	2.02.056.00	22
1.44.058.00	143	2.01.053.00	9	2.01.099.00	11	2.02.060.00	27
1.44.058.20	143	2.01.054.00	10	2.01.100.00	16	2.02.062.00	27
1.44.059.00	143	2.01.055.00	10	2.01.101.00	16	2.02.064.00	24
1.44.059.20	143	2.01.056.00	14	2.01.102.00	16	2.02.064.11	24
1.44.060.00	145	2.01.057.00	14	2.01.103.00	16	2.02.066.00	24
1.44.061.00	145	2.01.058.00	10	2.01.104.00	8	2.02.066.12	24
1.44.063.01	145	2.01.059.00	10	2.01.105.00	8	2.02.068.00	24
1.44.064.00	146	2.01.060.00	10	2.01.106.12	6	2.02.070.00	24
1.44.064.21	146	2.01.061.00	10	2.01.107.12	6	2.02.172.12	18
1.44.065.00	146	2.01.062.12	12	2.01.108.00	6	2.02.174.12	19
1.44.066.01	146	2.01.063.12	12	2.01.109.00	6	2.02.176.12	19
1.44.067.01	146	2.01.064.11	12	2.01.110.12	7	2.02.178.12	19
1.44.068.00	178	2.01.065.11	12	2.01.111.12	7	2.02.180.12	19
1.44.069.00	178	2.01.066.24	9	2.01.112.00	15	2.02.182.11	22
1.44.074.00	158	2.01.067.24	9	2.01.113.00	15	2.02.182.12	22
1.44.074.20	158	2.01.068.25	9	2.01.114.00	15	2.02.184.12	24
1.44.075.01	158	2.01.069.25	9	2.01.115.00	15	2.02.186.12	24
1.44.075.21	158	2.01.070.00	12	2.01.118.11	13	2.02.188.00	25
1.44.094.00	157	2.01.071.00	12	2.01.119.11	13	2.02.190.11	25
1.44.096.00	140	2.01.072.00	13	2.01.120.12	13	2.02.190.12	25
1.44.098.00	142	2.01.073.00	13	2.01.121.12	13	2.02.192.12	26
1.44.100.00	147	2.01.074.00	17	2.01.122.00	15	2.04.050.10	37
1.44.101.00	147	2.01.075.00	17	2.01.122.24	15	2.04.051.10	37
1.44.102.70	147	2.01.076.00	13	2.01.124.00	6	2.04.052.10	37
1.44.103.01	147	2.01.077.00	13	2.01.124.12	6	2.04.053.10	37
1.44.104.00	140	2.01.078.00	14	2.01.125.00	6	2.04.054.00	50
1.44.105.00	140	2.01.079.00	14	2.01.125.12	6	2.04.054.20	50
1.44.106.00	140	2.01.080.00	14	2.01.126.00	10	2.04.055.00	50
1.44.107.00	140	2.01.081.00	14	2.01.127.00	10	2.04.055.20	50
1.45.050.00	194	2.01.084.00	11	2.01.128.00	8	2.04.056.00	36
1.45.052.00	193	2.01.084.24	11	2.01.129.00	8	2.04.056.20	36
1.45.054.00	192	2.01.085.00	11	2.01.130.00	14	2.04.057.00	36
1.45.060.00	194	2.01.085.24	11	2.01.131.00	14	2.04.057.20	36
1.45.062.00	192	2.01.086.00	12	2.01.132.00	14	2.04.058.10	46
1.45.064.00	192	2.01.086.25	12	2.01.133.00	14	2.04.059.10	46
1.45.066.00	193	2.01.087.00	12	2.01.134.12	15	2.04.060.10	39
1.45.068.00	192	2.01.087.25	12	2.01.135.12	15	2.04.061.10	39
1.46.050.00	197	2.01.088.00	7	2.01.136.12	15	2.04.062.10	34
1.46.052.00	197	2.01.089.00	7	2.01.137.12	15	2.04.063.10	34
1.48.054.00	202	2.01.090.00	7	2.01.138.00	16	2.04.064.00	50
1.48.056.00	201	2.01.091.00	7	2.01.139.00	16	2.04.064.22	50
1.48.058.00	201	2.01.092.00	8	2.01.140.00	16	2.04.066.00	50
1.48.060.00	201	2.01.093.00	8	2.01.141.00	16	2.04.066.21	50
1.48.060.80	201	2.01.094.00	11	2.01.142.12	16	2.04.068.00	49

CODICE/CODE	PAG.	CODICE/CODE	PAG.	CODICE/CODE	PAG.	CODICE/CODE	PAG.
2.04.068.20	49	2.41.049.25	89	2.41.106.00	98	2.42.080.80	96
2.04.069.00	49	2.41.050.00	92	2.41.106.27	98	2.42.081.00	106
2.04.069.20	49	2.41.051.00	92	2.41.108.12	89	2.42.082.80	108
2.04.070.10	43	2.41.054.00	90	2.41.109.12	89	2.42.084.00	106
2.04.071.10	43	2.41.056.00	98	2.41.110.27	88	2.42.085.00	106
2.04.072.10	43	2.41.058.00	98	2.41.111.27	88	2.42.086.00	107
2.04.073.10	43	2.41.058.01	91	2.41.112.00	98	2.42.087.00	107
2.04.074.10	38	2.41.058.27	91	2.41.112.27	98	2.42.088.00	107
2.04.075.10	38	2.41.059.01	91	2.41.113.00	98	2.42.089.00	107
2.04.076.10	37	2.41.059.27	91	2.41.113.27	98	2.42.090.00	106
2.04.077.10	37	2.41.060.00	96	2.41.114.12	88	2.42.091.00	106
2.04.078.00	35	2.41.061.00	96	2.41.116.20	88	2.42.092.00	110
2.04.078.20	35	2.41.062.00	93	2.41.118.00	97	2.42.094.80	170
2.04.079.00	35	2.41.064.00	93	2.41.120.00	90	2.42.096.00	108
2.04.079.20	35	2.41.065.00	93	2.41.121.00	90	2.42.097.00	108
2.04.080.00	35	2.41.066.00	91	2.41.122.11	94	2.42.098.80	111
2.04.080.20	35	2.41.067.00	91	2.41.122.12	94	2.42.100.80	111
2.04.081.00	35	2.41.068.10	95	2.41.123.11	94	2.42.102.00	107
2.04.081.20	35	2.41.069.10	95	2.41.123.12	94	2.42.102.24	107
2.04.082.10	35	2.41.070.00	93	2.41.126.25	91	2.42.104.00	104
2.04.083.10	35	2.41.072.00	93	2.41.127.25	91	2.42.106.00	105
2.04.086.10	35	2.41.074.00	93	2.42.050.00	92	2.42.108.80	110
2.04.087.10	35	2.41.076.00	171	2.42.052.00	111	2.42.110.80	111
2.04.088.00	48	2.41.078.80	170	2.42.053.00	111	2.42.116.00	107
2.04.089.00	48	2.41.080.00	93	2.42.054.00	111	2.42.117.00	100
2.04.090.10	58	2.41.082.00	97	2.42.055.00	111	2.42.118.00	100
2.04.090.20	58	2.41.084.00	97	2.42.056.11	109	2.42.118.24	100
2.04.091.10	58	2.41.086.19	96	2.42.058.80	108	2.42.120.00	100
2.04.091.20	58	2.41.086.27	96	2.42.060.12	104	2.42.122.00	100
2.04.092.20	59	2.41.087.27	96	2.42.061.12	104	2.42.124.11	102
2.04.093.20	59	2.41.088.00	94	2.42.062.80	110	2.42.124.12	102
2.04.094.10	59	2.41.089.00	94	2.42.064.80	109	2.42.125.11	102
2.04.095.10	59	2.41.090.00	89	2.42.066.00	100	2.42.125.12	102
2.04.096.10	63	2.41.091.00	89	2.42.066.24	100	2.42.126.11	102
2.04.097.10	63	2.41.092.00	96	2.42.068.12	104	2.42.127.11	102
2.04.098.10	67	2.41.094.00	92	2.42.069.12	104	2.43.040.00	117
2.04.099.10	67	2.41.095.00	92	2.42.070.00	100	2.43.040.80	127
2.04.102.10	46	2.41.096.00	94	2.42.072.00	107	2.43.042.00	117
2.04.103.10	46	2.41.097.00	94	2.42.073.00	107	2.43.042.80	127
2.04.104.10	38	2.41.098.80	96	2.42.074.00	105	2.43.044.00	123
2.05.050.00	71	2.41.100.00	90	2.42.075.00	105	2.43.044.10	123
2.05.052.00	72	2.41.101.00	90	2.42.076.00	105	2.43.045.00	123
2.05.054.00	74	2.41.102.00	88	2.42.076.17	134	2.43.046.00	123
2.05.056.00	74	2.41.102.27	88	2.42.076.18	105	2.43.047.00	123
2.05.105.10	38	2.41.103.00	88	2.42.078.00	106	2.43.048.00	117
2.41.048.00	89	2.41.103.27	88	2.42.078.17	134	2.43.048.11	117
2.41.048.25	89	2.41.104.27	88	2.42.078.18	106	2.43.048.18	117
2.41.049.00	89	2.41.105.27	88	2.42.080.00	106	2.43.048.21	117

CODICE/CODE	PAG.	CODICE/CODE	PAG.	CODICE/CODE	PAG.	CODICE/CODE	PAG.
2.43.048.22	117	2.43.103.81	133	2.43.176.80	126	2.43.235.80	133
2.43.048.80	127	2.43.112.00	122	2.43.178.80	126	2.43.236.80	133
2.43.049.00	123	2.43.114.00	122	2.43.180.80	126	2.43.237.80	133
2.43.050.00	123	2.43.116.80	124	2.43.182.00	124	2.43.238.80	128
2.43.051.00	123	2.43.118.80	124	2.43.182.21	124	2.43.240.80	128
2.43.052.80	115	2.43.120.80	124	2.43.184.00	124	2.43.242.80	128
2.43.052.81	127	2.43.122.80	127	2.43.184.25	124	2.43.244.80	128
2.43.054.81	127	2.43.124.80	127	2.43.186.80	132	2.43.246.80	129
2.43.056.81	127	2.43.126.00	123	2.43.186.81	132	2.43.248.00	119
2.43.058.81	127	2.43.128.81	131	2.43.187.80	132	2.43.250.00	119
2.43.060.81	127	2.43.129.81	131	2.43.188.80	132	2.43.252.00	119
2.43.062.40	120	2.43.130.80	116	2.43.189.80	132	2.43.254.80	129
2.43.064.18	120	2.43.131.80	116	2.43.190.80	132	2.43.255.80	129
2.43.066.40	120	2.43.132.80	115	2.43.191.80	132	2.43.256.80	129
2.43.068.00	124	2.43.134.80	131	2.43.192.80	132	2.43.257.80	129
2.43.068.24	124	2.43.136.80	131	2.43.193.80	132	2.43.258.80	129
2.43.070.00	124	2.43.138.80	131	2.43.194.80	124	2.43.262.80	134
2.43.072.00	123	2.43.140.80	115	2.43.195.80	129	2.43.263.80	134
2.43.072.18	123	2.43.141.80	115	2.43.195.81	129	2.43.264.80	134
2.43.072.22	123	2.43.142.00	119	2.43.196.80	125	2.43.266.00	122
2.43.072.25	123	2.43.142.22	119	2.43.197.80	125	2.43.268.00	122
2.43.074.00	123	2.43.142.24	119	2.43.198.80	125	2.43.270.00	122
2.43.076.81	131	2.43.142.25	119	2.43.199.80	125	2.43.272.00	117
2.43.077.81	131	2.43.142.26	119	2.43.200.80	125	2.43.272.80	128
2.43.078.81	131	2.43.143.00	119	2.43.201.80	125	2.43.274.00	117
2.43.079.81	131	2.43.144.00	119	2.43.202.80	131	2.43.274.80	128
2.43.080.00	123	2.43.145.00	119	2.43.204.80	131	2.43.276.00	117
2.43.082.00	123	2.43.146.00	119	2.43.206.80	131	2.43.276.80	128
2.43.084.81	134	2.43.147.00	119	2.43.208.80	130	2.43.278.00	118
2.43.085.81	134	2.43.148.00	119	2.43.210.80	130	2.43.280.00	118
2.43.086.81	134	2.43.149.00	120	2.43.212.80	130	2.43.282.00	118
2.43.087.81	134	2.43.149.24	120	2.43.214.80	130	2.43.284.00	121
2.43.088.00	125	2.43.150.80	133	2.43.216.80	130	2.43.286.00	121
2.43.088.26	125	2.43.151.80	133	2.43.218.00	110	2.43.288.80	128
2.43.089.00	125	2.43.152.80	133	2.43.220.00	121	2.43.289.80	128
2.43.090.80	130	2.43.153.80	133	2.43.220.22	121	2.43.290.80	128
2.43.091.80	112	2.43.154.80	133	2.43.220.24	121	2.43.291.80	128
2.43.092.80	130	2.43.155.80	133	2.43.220.25	121	2.43.292.80	128
2.43.094.80	130	2.43.156.80	133	2.43.221.00	121	2.43.293.80	128
2.43.096.80	130	2.43.158.80	126	2.43.222.00	121	2.43.294.00	118
2.43.098.00	120	2.43.160.80	126	2.43.224.00	121	2.43.296.00	118
2.43.098.24	120	2.43.162.80	126	2.43.224.26	121	2.43.298.00	118
2.43.099.00	120	2.43.164.80	126	2.43.226.00	121	2.43.300.00	118
2.43.100.00	120	2.43.166.80	126	2.43.228.00	121	2.43.308.00	118
2.43.100.24	120	2.43.168.80	126	2.43.230.00	121	2.43.310.00	118
2.43.102.00	120	2.43.170.80	126	2.43.230.25	121	2.43.312.00	118
2.43.102.81	133	2.43.172.80	126	2.43.232.80	133	2.43.314.00	118
2.43.103.00	120	2.43.174.80	126	2.43.234.80	133	2.43.316.00	118

CODICE/CODE	PAG.	CODICE/CODE	PAG.	CODICE/CODE	PAG.	CODICE/CODE	PAG.
2.43.318.00	117	2.44.071.00	141	2.44.121.00	152	2.44.186.00	165
2.43.320.00	117	2.44.072.00	142	2.44.123.01	152	2.44.187.01	165
2.43.322.00	117	2.44.072.10	142	2.44.124.00	156	2.44.188.00	165
2.43.325.00	120	2.44.073.00	142	2.44.124.20	156	2.44.189.01	165
2.44.040.00	141	2.44.073.10	142	2.44.125.00	156	2.44.190.00	176
2.44.046.20	137	2.44.074.00	167	2.44.127.01	156	2.44.190.20	176
2.44.048.00	140	2.44.074.20	167	2.44.128.00	180	2.44.191.00	176
2.44.049.00	140	2.44.075.01	167	2.44.128.21	180	2.44.192.81	170
2.44.050.10	141	2.44.076.01	168	2.44.130.00	180	2.44.193.81	170
2.44.051.10	141	2.44.076.10	155	2.44.132.00	180	2.44.194.80	170
2.44.052.10	141	2.44.076.20	168	2.44.134.00	180	2.44.195.80	170
2.44.053.10	141	2.44.077.10	155	2.44.134.11	180	2.44.196.80	170
2.44.054.10	140	2.44.078.00	153	2.44.136.00	180	2.44.198.80	170
2.44.055.10	140	2.44.078.20	153	2.44.136.25	180	2.44.204.80	172
2.44.056.00	137	2.44.079.00	153	2.44.138.00	146	2.44.206.10	138
2.44.056.10	137	2.44.079.20	153	2.44.139.01	146	2.44.207.10	138
2.44.056.18	137	2.44.081.01	153	2.44.140.80	170	2.44.210.80	181
2.44.057.00	137	2.44.082.80	182	2.44.144.80	170	2.44.212.80	181
2.44.057.10	137	2.44.083.80	182	2.44.148.80	170	2.44.213.80	181
2.44.058.00	138	2.44.084.80	169	2.44.152.80	170	2.44.214.10	167
2.44.058.10	138	2.44.086.80	169	2.44.156.80	171	2.44.215.10	167
2.44.059.00	138	2.44.087.80	169	2.44.160.80	171	2.44.216.00	150
2.44.059.10	138	2.44.088.80	169	2.44.162.80	171	2.44.216.20	150
2.44.060.00	142	2.44.089.80	169	2.44.164.00	140	2.44.217.00	150
2.44.060.10	142	2.44.090.80	181	2.44.165.00	140	2.44.217.20	150
2.44.061.00	142	2.44.091.80	181	2.44.166.00	171	2.44.218.00	150
2.44.061.10	142	2.44.092.80	169	2.44.167.00	171	2.44.219.00	150
2.44.062.00	154	2.44.094.80	169	2.44.168.00	171	2.44.220.10	143
2.44.062.10	154	2.44.096.80	169	2.44.169.00	171	2.44.221.10	143
2.44.062.18	154	2.44.098.80	169	2.44.170.00	171	2.44.224.00	178
2.44.063.00	154	2.44.100.80	169	2.44.171.00	171	2.44.224.20	178
2.44.063.10	154	2.44.102.80	169	2.44.172.00	156	2.44.225.00	178
2.44.064.00	144	2.44.104.00	174	2.44.173.01	156	2.44.225.20	178
2.44.064.20	144	2.44.105.00	174	2.44.174.00	163	2.44.226.00	179
2.44.065.00	144	2.44.106.00	179	2.44.174.20	151	2.44.226.20	179
2.44.065.20	144	2.44.106.20	179	2.44.175.01	163	2.44.227.00	179
2.44.066.00	168	2.44.107.01	179	2.44.176.00	151	2.44.227.20	179
2.44.066.20	168	2.44.107.21	179	2.44.177.01	151	2.44.228.00	139
2.44.066.30	168	2.44.108.10	154	2.44.178.00	159	2.44.228.20	139
2.44.066.80	168	2.44.109.10	154	2.44.178.20	159	2.44.229.00	139
2.44.067.00	168	2.44.110.00	137	2.44.179.01	159	2.44.229.20	139
2.44.067.80	168	2.44.111.00	137	2.44.180.00	160	2.44.232.00	136
2.44.068.00	173	2.44.112.00	167	2.44.181.01	160	2.44.232.20	136
2.44.068.20	173	2.44.113.00	167	2.44.182.00	155	2.44.234.00	196
2.44.069.00	173	2.44.118.00	156	2.44.182.20	154	2.44.238.20	174
2.44.069.20	173	2.44.118.20	156	2.44.183.01	155	2.44.238.80	174
2.44.070.00	141	2.44.119.01	156	2.44.184.00	154	2.44.239.80	174
2.44.070.20	141	2.44.120.00	152	2.44.185.01	154	2.44.239.81	174

CODICE/CODE	PAG.	CODICE/CODE	PAG.	CODICE/CODE	PAG.	CODICE/CODE	PAG.
2.44.242.00	163	2.44.290.20	164	2.47.081.80	99	2021001047	65
2.44.243.00	163	2.44.291.01	164	2.47.082.80	99	2021001049	63
2.44.244.00	163	2.44.292.00	164	2.47.086.80	99	2021001050	54
2.44.246.00	163	2.44.292.20	164	2.47.088.80	99	2021001051	54
2.44.248.00	163	2.44.293.01	164	2.47.089.80	99	2021001052	54
2.44.250.80	173	2.44.294.10	140	2.47.090.80	99	2021001053	54
2.44.252.80	173	2.44.295.10	140	2.47.092.80	99	2021001054	54
2.44.254.00	167	2.45.050.00	192	2.47.094.00	206	2021001056	65
2.44.254.20	167	2.45.051.00	192	2.47.096.00	206	2021001102	51
2.44.255.01	167	2.45.052.00	193	2.47.098.80	204	2021001104	51
2.44.258.00	167	2.45.053.00	193	2.47.100.80	205	2021001105	51
2.44.258.20	167	2.45.054.00	194	2.47.102.80	205	2021001107	50
2.44.260.10	158	2.45.056.00	194	2.48.050.80	202	2021001114	34
2.44.261.10	158	2.45.058.00	194	2.48.052.80	202	2021001117	52
2.44.262.00	172	2.45.060.00	194	2.48.058.80	202	2021001118	52
2.44.263.00	172	2.45.062.00	194	2.48.060.80	202	2021001119	51
2.44.263.01	172	2.45.064.00	195	2.48.062.80	202	2021001121	53
2.44.264.10	140	2.45.066.00	195	2020001040	83	2021001122	52
2.44.265.10	140	2.45.068.80	195	2020001045	83	2021001123	52
2.44.266.10	142	2.45.070.80	195	2020001067	82	2021001124	52
2.44.267.10	142	2.45.072.80	195	2020001069	82	2021101015	53
2.44.268.80	169	2.45.074.80	196	2020001105	79	2021101019	66
2.44.270.80	169	2.45.076.00	196	2020001107	79	2021101021	67
2.44.271.80	169	2.45.078.80	196	2020001108	83	2021101023	50
2.44.272.10	138	2.45.080.00	193	2020101040	83	2021101025	51
2.44.273.10	138	2.45.082.00	194	2020101045	83	2021101027	33
2.44.276.00	153	2.45.083.00	194	2020101067	82	2021101028	33
2.44.276.10	153	2.47.050.00	203	2020101069	82	2021101031	53
2.44.276.70	153	2.47.050.23	203	2020101105	79	2021101035	53
2.44.277.01	153	2.47.050.80	204	2020101107	79	2021101036	64
2.44.278.00	141	2.47.052.00	203	2020101108	83	2021101037	64
2.44.278.10	141	2.47.052.80	204	2020201005	84	2021101038	64
2.44.279.00	141	2.47.054.00	203	2020301005	84	2021101042	66
2.44.279.10	141	2.47.054.80	204	2021001015	53	2021101045	58
2.44.280.80	173	2.47.055.00	203	2021001019	66	2021101046	65
2.44.281.80	173	2.47.058.00	203	2021001021	67	2021101047	65
2.44.282.80	173	2.47.060.00	206	2021001023	50	2021101049	63
2.44.283.80	173	2.47.062.00	206	2021001025	51	2021101050	54
2.44.284.00	157	2.47.064.00	206	2021001027	33	2021101051	54
2.44.284.21	157	2.47.066.00	206	2021001028	33	2021101052	54
2.44.285.00	157	2.47.068.00	206	2021001031	53	2021101053	54
2.44.286.01	157	2.47.070.00	206	2021001035	53	2021101054	54
2.44.287.01	157	2.47.072.00	207	2021001036	64	2021101056	65
2.44.288.00	177	2.47.074.00	207	2021001037	64	2021101102	51
2.44.288.20	177	2.47.076.00	207	2021001038	64	2021101104	51
2.44.289.00	177	2.47.077.00	207	2021001042	66	2021101105	51
2.44.289.20	177	2.47.078.00	207	2021001045	58	2021101107	50
2.44.290.00	164	2.47.080.80	99	2021001046	65	2021101114	34

CODICE/CODE	PAG.	CODICE/CODE	PAG.	CODICE/CODE	PAG.	CODICE/CODE	PAG.
2021101117	52	3.49.080.00	173	4.44.080.00	166	4.46.50.70	216
2021101118	52	3.49.082.00	139	4.44.080.70	166	4.46.50.80	216
2021101119	51	3.49.084.00	210	4.44.081.01	166	4.46.50.90	216
2021101121	53	3.49.086.00	210	4.44.084.01	151	4.46.51.00	216
2021101122	52	3.49.088.00	172	4.44.084.20	151	4.46.60.01	216
2021101123	52	3.49.089.00	172	4.44.085.01	151	4.46.60.02	216
2021101124	52	3.49.090.00	147	4.44.098.80	142	4.46.60.03	216
2023101002	34	3.49.092.00	209	4.44.100.80	142	4.46.60.04	216
2024001002	34	3.49.094.00	209	4.44.102.80	142	4.46.60.05	217
2024001003	34	3.49.095.00	209	4.44.104.80	142	4.46.60.06	217
2024101003	34	3.49.096.00	135	4.46.054.90	198	4.46.70.01	217
2025201002	34	4.14.000.03	220	4.46.054.91	198	4.46.71.01	214
2025301002	34	4.14.000.04	220	4.46.054.92	198	4.46.71.03	214
3.09.050.00	36	4.14.000.07	220	4.46.056.90	199	4.46.71.05	214
3.09.052.00	36	4.14.000.08	220	4.46.056.91	199	4.46.71.07	215
3.09.054.00	36	4.41.054.00	94	4.46.056.92	199	4.46.71.09	215
3.47.050.00	212	4.41.055.00	94	4.46.058.90	197	4.46.71.11	215
3.47.052.00	212	4.42.054.80	111	4.46.058.91	197	4.46.71.13	215
3.47.054.00	212	4.42.056.07	219	4.46.058.92	197	4.46.71.15	215
3.47.056.00	212	4.42.056.08	219	4.46.060.90	198	4.46.71.17	215
3.47.058.00	189	4.42.056.80	108	4.46.060.91	198	4.46.79.57	209
3.47.062.00	190	4.42.060.80	108	4.46.060.92	198	4.55.324.11	220
3.47.064.00	190	4.42.062.80	109	4.46.062.90	197	4.55.324.22	220
3.47.066.80	191	4.42.130.00	219	4.46.062.91	197	5.01.052.00	6
3.47.068.80	191	4.42.743.00	218	4.46.062.92	197	5.01.053.00	6
3.47.07.880	190	4.42.842.00	218	4.46.064.90	198	5.01.054.00	13
3.47.070.80	191	4.42.956.00	218	4.46.064.91	198	5.01.055.00	13
3.47.072.80	190	4.43.058.80	112	4.46.064.92	198	5.02.050.12	22
3.47.074.80	191	4.43.060.80	112	4.46.066.90	200	5.02.051.12	22
3.47.076.80	190	4.44.052.00	164	4.46.066.91	200	5.02.054.12	22
3.49.050.00	210	4.44.052.20	164	4.46.066.92	200	5.02.055.12	22
3.49.052.00	208	4.44.053.00	164	4.46.068.90	199	5.02.058.00	19
3.49.054.00	208	4.44.056.00	164	4.46.068.91	199	5.02.068.00	19
3.49.056.00	210	4.44.057.01	164	4.46.068.92	199	5.02.069.00	19
3.49.056.50	208	4.44.058.00	164	4.46.070.90	199	5.02.076.00	23
3.49.057.00	210	4.44.058.20	164	4.46.070.91	199	5.02.077.00	23
3.49.057.50	208	4.44.059.00	164	4.46.070.92	199	5.02.078.00	23
3.49.058.00	210	4.44.060.00	164	4.46.072.90	200	5.02.079.00	23
3.49.060.00	193	4.44.061.01	164	4.46.074.90	200	5.02.080.00	24
3.49.063.00	208	4.44.064.00	160	4.46.076.90	200	5.02.081.00	24
3.49.064.00	208	4.44.065.01	160	4.46.40.01	214	5.02.082.00	24
3.49.066.00	208	4.44.066.01	165	4.46.40.02	214	5.02.083.00	24
3.49.070.00	211	4.44.067.01	165	4.46.40.04	214	5.02.084.00	24
3.49.071.00	211	4.44.068.00	161	4.46.40.05	214	5.02.085.00	24
3.49.073.50	210	4.44.068.70	161	4.46.40.51	214	5.02.088.00	24
3.49.075.00	209	4.44.069.01	161	4.46.50.15	215	5.02.089.00	24
3.49.076.00	28	4.44.070.00	152	4.46.50.40	215	5.02.090.00	24
3.49.078.00	28	4.44.071.01	152	4.46.50.60	216	5.02.091.00	24

CODICE/CODE	PAG.	CODICE/CODE	PAG.	CODICE/CODE	PAG.	CODICE/CODE	PAG.
5.02.092.00	25	5.04.102.00	40	5.04.198.00	38	5.41.068.00	89
5.02.093.00	25	5.04.103.00	40	5.04.199.00	38	5.41.069.00	89
5.02.094.00	28	5.04.104.00	43	5.04.200.00	45	5.41.070.00	90
5.02.095.00	28	5.04.105.00	43	5.04.201.00	45	5.41.071.00	90
5.02.096.00	28	5.04.108.00	44	5.04.208.10	67	5.41.072.00	90
5.02.097.00	28	5.04.109.00	44	5.04.209.10	67	5.41.073.00	90
5.02.098.00	28	5.04.110.00	55	5.04.210.00	68	5.41.080.00	95
5.02.099.00	28	5.04.111.00	55	5.04.211.00	68	5.41.081.00	95
5.02.100.12	26	5.04.112.00	41	5.04.212.00	53	5.41.084.00	95
5.02.101.12	26	5.04.113.00	41	5.04.213.00	53	5.41.085.00	95
5.02.102.12	26	5.04.120.00	63	5.04.214.00	58	5.41.086.00	90
5.02.103.12	26	5.04.121.00	63	5.04.215.00	58	5.41.087.00	90
5.04.052.00	37	5.04.122.00	63	5.04.216.00	44	5.42.050.00	105
5.04.053.00	37	5.04.123.00	63	5.04.217.00	44	5.42.054.00	102
5.04.054.00	46	5.04.134.00	68	5.04.250.00	55	5.42.055.00	102
5.04.055.00	46	5.04.135.00	68	5.04.251.00	55	5.42.056.12	101
5.04.056.00	48	5.04.150.00	68	5.04.252.00	38	5.42.057.12	101
5.04.057.00	48	5.04.151.00	68	5.04.253.00	38	5.42.058.12	101
5.04.058.00	48	5.04.152.00	46	5.04.254.00	48	5.42.059.12	101
5.04.059.00	48	5.04.153.00	46	5.04.255.00	48	5.42.062.00	109
5.04.062.00	68	5.04.154.00	46	5.04.256.00	49	5.42.062.99	109
5.04.063.00	68	5.04.155.00	46	5.04.257.00	49	5.42.063.00	109
5.04.064.00	68	5.04.158.00	44	5.04.258.00	40	5.42.065.00	109
5.04.065.00	68	5.04.159.00	44	5.04.259.00	40	5.42.066.12	26
5.04.066.10	36	5.04.160.00	43	5.05.050.00	70	5.42.067.12	26
5.04.067.10	36	5.04.161.00	43	5.05.052.00	72	5.42.068.12	26
5.04.068.00	47	5.04.162.00	40	5.05.060.00	74	5.42.069.12	26
5.04.069.00	47	5.04.163.00	40	5.06.050.00	70	5.42.070.00	106
5.04.070.00	37	5.04.172.00	34	5.06.068.00	76	5.42.072.80	110
5.04.071.00	37	5.04.173.00	34	5.06.069.00	76	5.42.076.80	111
5.04.072.00	57	5.04.178.00	33	5.06.070.00	77	5.42.078.00	109
5.04.073.00	57	5.04.179.00	33	5.06.071.00	77	5.42.080.00	109
5.04.078.00	29	5.04.180.00	33	5.06.072.00	77	5.43.054.00	122
5.04.079.00	29	5.04.181.00	33	5.06.073.00	77	5.43.056.00	106
5.04.080.00	30	5.04.182.00	45	5.06.074.00	77	5.43.058.00	110
5.04.081.00	30	5.04.182.19	45	5.06.075.00	77	5.43.060.00	115
5.04.084.00	46	5.04.183.00	45	5.06.080.00	77	5.43.062.00	112
5.04.085.00	46	5.04.183.19	45	5.06.081.00	77	5.43.063.00	112
5.04.086.00	30	5.04.190.00	30	5.41.050.00	91	5.43.064.80	116
5.04.087.00	30	5.04.191.00	30	5.41.051.00	91	5.43.065.80	116
5.04.090.00	29	5.04.192.00	30	5.41.054.00	91	5.43.066.80	116
5.04.091.00	29	5.04.193.00	30	5.41.055.00	91	5.43.068.80	116
5.04.096.00	36	5.04.194.00	31	5.41.056.00	89	5.43.069.80	116
5.04.097.00	36	5.04.194.17	31	5.41.057.00	89	5.43.070.80	116
5.04.098.00	36	5.04.195.00	31	5.41.062.00	95	5.43.071.80	116
5.04.099.00	36	5.04.195.17	31	5.41.063.00	95	5.44.058.00	157
5.04.100.00	40	5.04.196.00	37	5.41.064.00	95	5.44.059.00	157
5.04.101.00	40	5.04.197.00	37	5.41.065.00	95	5.44.060.00	151

CODICE/CODE	PAG.	CODICE/CODE	PAG.	CODICE/CODE	PAG.	CODICE/CODE	PAG.
5.44.060.20	151	5.44.098.70	145	5.44.126.20	183	67.1142	223
5.44.061.00	151	5.44.099.00	145	5.44.127.00	183	67.1143	223
5.44.061.20	151	5.44.099.01	145	5.44.127.20	183	67.1144	223
5.44.062.00	175	5.44.100.20	147	5.44.128.00	183	67.1145	223
5.44.062.20	175	5.44.100.78	147	5.44.128.20	183	67.1146	223
5.44.063.00	175	5.44.100.80	147	5.44.129.00	183	67.1147	223
5.44.063.20	175	5.44.101.20	147	5.44.129.20	183	67.1148	223
5.44.066.00	158	5.44.101.80	147	5.47.050.80	205	67.1200	233
5.44.066.20	158	5.44.101.81	147	5.47.051.80	205	67.1207	225
5.44.067.00	158	5.44.102.78	148	5.47.052.80	205	67.1209	225
5.44.068.00	138	5.44.102.80	148	5.47.100.00	213	67.1210	225
5.44.068.19	138	5.44.103.80	148	5.47.200.00	213	67.1213	225
5.44.069.00	138	5.44.103.81	148	5.47.200.50	213	67.1217	233
5.44.069.19	138	5.44.104.00	148	6.49.050.00	211	67.1227	225
5.44.070.00	155	5.44.104.20	148	6.49.052.00	211	67.1300	233
5.44.070.20	155	5.44.104.70	148	6.49.054.00	211	67.1317	233
5.44.071.01	155	5.44.105.01	148	6.49.055.00	209	67.1400	233
5.44.071.20	155	5.44.105.20	148	67.0103	229	67.1417	233
5.44.072.00	161	5.44.106.00	149	67.0107	229	67.1490	234
5.44.073.01	161	5.44.106.70	149	67.0383	224	67.1500	234
5.44.074.00	174	5.44.107.00	149	67.0384	224	67.1517	234
5.44.074.20	174	5.44.107.01	149	67.0399	224	67.1550	234
5.44.075.00	174	5.44.108.20	159	67.0400	224	67.1617	235
5.44.075.20	174	5.44.108.80	159	67.0657	224	67.1650	234
5.44.076.00	155	5.44.108.81	159	67.0658	222	67.1700	235
5.44.077.00	155	5.44.109.80	159	67.0659	222	67.1800	235
5.44.080.00	143	5.44.110.00	162	67.0660	222	67.1887	223
5.44.081.00	143	5.44.111.00	162	67.0661	222	67.1888	223
5.44.084.00	146	5.44.112.20	162	67.0662	222	67.1900	235
5.44.086.00	146	5.44.112.80	163	67.0663	222	67.2000	234
5.44.088.00	138	5.44.113.20	162	67.0664	222	67.2100	234
5.44.089.00	138	5.44.113.81	163	67.1032.01	224	67.2117	234
5.44.090.00	135	5.44.114.80	162	67.1032.50	224	67.2301	222
5.44.090.20	135	5.44.115.80	162	67.1033.01	224	67.2302	222
5.44.090.70	135	5.44.115.81	162	67.1033.50	224	67.2307	222
5.44.091.01	135	5.44.116.00	153	67.1034.51	224	67.2309	222
5.44.091.20	135	5.44.117.00	153	67.1067	225	67.2310	222
5.44.092.00	135	5.44.118.20	166	67.1068	225	67.2323	222
5.44.092.70	135	5.44.118.80	166	67.1069	226	67.2328	222
5.44.093.01	135	5.44.119.80	166	67.1070	226	67.2329	222
5.44.094.20	136	5.44.119.81	166	67.1073	225	67.2347	222
5.44.094.80	136	5.44.120.80	176	67.1074	225	67.2348	222
5.44.095.20	136	5.44.121.80	176	67.1075	225	67.2349	222
5.44.095.80	136	5.44.122.00	157	67.1076	225	67.2357	222
5.44.096.80	136	5.44.123.00	157	67.1077	225	67.2358	222
5.44.097.80	136	5.44.124.00	138	67.1078	225	67.2367	222
5.44.098.00	145	5.44.125.00	138	67.1100	233	67.2368	222
5.44.098.20	145	5.44.126.00	183	67.1141	223	67.2369	222

CODICE/CODE	PAG.	CODICE/CODE	PAG.	CODICE/CODE	PAG.	CODICE/CODE	PAG.
68.31.800	225	68.9.527.012	226	8.00.067.00	81	8.40.060.00	185
68.31.802	225	7.43.056.00	124	8.00.068.00	82	8.40.061.00	185
68.31.806	225	7.43.057.00	124	8.00.069.00	82	8.40.066.00	185
68.31.809	225	7.43.060.31	116	8.00.070.00	82	8.40.067.00	185
68.31.810	225	7.43.064.41	125	8.00.071.00	82	8.40.068.00	186
68.31.812	225	7.43.070.80	132	8.00.072.00	83	8.40.069.00	186
68.31.815	225	7.43.071.80	132	8.00.073.00	83	8.40.070.00	186
68.31.819	225	7.43.074.81	126	8.00.076.00	80	8.40.071.00	186
68.31.820	225	7.43.078.81	126	8.00.077.00	80	8.40.076.00	187
68.31.823	225	7.43.080.81	125	8.00.078.00	80	8.40.077.00	187
68.31.825	225	7.43.084.81	125	8.00.079.00	80	8.40.078.00	187
68.5.200.025	231	7.43.086.81	125	8.00.080.00	80	8.40.079.00	187
68.5.401.045	226	7.44.050.00	177	8.00.081.00	80	8.40.080.00	187
68.5.622.000	227	7.44.050.20	177	8.00.090.00	81	8.40.081.00	187
68.5.631.000	227	7.44.051.00	177	8.00.091.00	81	8.40.086.00	185
68.5.631.001	227	7.44.054.00	177	8.00.092.00	79	8.40.088.00	184
68.5.675.025	230	7.44.054.20	177	8.00.093.00	79	8.40.088.19	184
68.5.752.025	222	7.44.055.00	177	8.00.134.00	82	8.40.089.00	184
68.5.753.025	231	7.44.056.00	175	8.00.135.00	82	8.40.090.00	185
68.5.789.025	229	7.44.057.00	175	8.00.142.00	82	8.40.091.00	185
68.5.791.025	230	7.44.058.00	176	8.00.143.00	82	8.40.092.00	186
68.5.793.025	230	7.44.059.00	176	8.00.146.00	81	8.40.093.00	186
68.5.796.025	229	7.44.060.00	175	8.00.147.00	81	8.40.100.00	184
68.6.152.025	231	7.44.060.20	175	8.00.148.00	9	8.40.102.00	185
68.6.418.025	231	7.44.061.00	175	8.00.149.00	9	8.40.103.00	185
68.6.622.000	228	7.44.061.20	175	8.20.050.00	84	8.40.104.00	184
68.7.417.V44Q	226	7.44.090.80	182	8.20.054.00	188	8.40.105.00	184
68.7.417.V45Q	226	7.44.091.80	182	8.20.056.00	84	8.40.106.00	184
68.7.418.V44Q	226	7.44.092.00	180	8.20.057.00	84	8.40.107.00	184
68.7.418.V45Q	226	7.44.093.00	180	8.20.068.00	85	8.50.054.00	188
68.7.517.020	228	7.44.094.80	182	8.20.070.00	85	8.50.056.00	188
68.7.521.V45	228	7.44.095.80	182	8.20.072.00	85	8.50.058.00	188
68.7.522.V45	228	7.44.096.20	182	8.20.073.00	85	8.50.058.17	189
68.7.523.V45	227	7.44.096.80	182	8.20.074.00	84	8.50.059.17	189
68.7.524.V45	227	7.44.097.20	182	8.20.082.00	85	8.50.060.00	189
68.7.525.V45	227	7.44.097.80	182	8.20.094.00	85	8.50.062.00	189
68.7.600.025	224	7.44.098.80	183	8.20.096.00	86	8.50.063.00	189
68.7.601.025	224	7.44.099.80	183	8.20.097.00	86	8.50.064.00	189
68.7.750.035	230	7.45.052.00	195	8.20.098.00	84	8.50.065.00	189
68.7.792.025	230	8.00.054.00	80	8.20.099.00	84	8.50.070.00	86
68.7.793.025	231	8.00.055.00	80	8.20.100.00	188	8.90.050.00	79
68.7.796.025	230	8.00.056.00	79	8.20.102.00	80	8.90.050.17	79
68.9.522.012	228	8.00.057.00	79	8.20.103.00	80	8.90.052.00	79
68.9.522.V25	228	8.00.060.00	81	8.40.042.00	186		
68.9.523.012	228	8.00.061.00	81	8.40.043.00	186		
68.9.523.V25	228	8.00.064.00	81	8.40.056.70	186		
68.9.525.012	228	8.00.065.00	81	8.40.058.00	184		
68.9.526.012	226	8.00.066.00	81	8.40.059.00	184		

original parts numbers

RIFERIMENTI ORIGINALI

RIFERIMENTI ORIGINALI ORIGINAL PARTS NUMBERS
AVVERTENZE PER LA CONSULTAZIONE

i riferimenti originali riportati nelle tabelle seguenti, sono forniti a mero titolo informativo ed il loro utilizzo nel presente catalogo ha l'unico scopo di aiutare e agevolare la corretta identificazione del modello di veicolo sul quale deve montarsi il pezzo di ricambio.

Si avverte, ad ogni fine, che la scelta dei prodotti deve essere determinata ed avvenire unicamente in base ai codici Olsa parts riportati nelle parti illustrative del catalogo.

NOTES FOR CONSULTATION

the original references which are reported in the following tables are provided for information purposes only and their use in this catalogue must be intended only and just to help and facilitate the correct identification of the vehicle model on which the spare parts must be fitted to.

In any event, we warn that the choice of products must be determined only by and according to Olsa parts references contained in the illustrated sections of this catalogue.

ALFA ROMEO	OLSA Parts				
9946766	2.01.108.00	50522993	1.02.160.00	71736431	5.04.081.00
9946767	2.01.109.00	50550396	1.05.072.80	71746402	5.01.052.00
46408006	1.05.054.00	50550396	1.05.080.80	71746403	5.01.053.00
46546918	1.06.076.00	51822766	1.02.058.12	71752162	5.04.194.00
46546919	1.06.077.00	51925086	1.04.144.00	71752163	5.04.195.00
46556346	1.04.053.00	60574850	1.05.050.00	71752164	5.04.195.17
46556347	1.04.050.00	60582887	2.01.106.12	71752165	5.04.194.17
46556348	1.04.052.00	60582888	2.01.107.12	517134000	1.05.104.00
46556349	1.04.051.00	60597299	1.02.126.00	606793660	1.06.054.00
46556563	1.02.052.00	60597300	1.02.127.00	ASPOCK	OLSA Parts
46776234	1.06.052.00	60597342	1.06.056.00	13.5626.940	3.49.095.00
46778631	1.06.053.00	60620141	1.02.056.00	13.5626.950	3.49.094.00
46786572	1.05.052.00	60620142	1.02.057.00	18-8570-001	7.44.097.20
50504339	1.06.078.00	60620256	1.06.081.00	18-8570-101	7.44.096.20
50504340	1.06.079.00	60620257	1.06.080.00	25-3800-507	7.44.091.80
50504818	5.04.090.00	60681558	5.04.078.00	25-3900-507	7.44.090.80
50504821	5.04.091.00	60681559	5.04.079.00	25-7000-507	7.44.093.00
50508590	8.00.056.00	60686516	1.02.054.12	25-7000-707	7.44.097.80
50508592	8.00.057.00	60686517	1.02.055.12	25-7000-727	7.44.095.80
50513400	5.04.192.00	60691105	1.02.125.00	25-7400-507	7.44.092.00
50513401	5.04.193.00	60691106	1.02.124.00	25--7400-707	7.44.096.80
50513612	5.04.190.00	60692719	8.20.050.00	25--7400-727	7.44.094.80
50513613	5.04.191.00	60693791	1.04.054.00	KM 21.2200.014	7.43.080.81
50513758	1.02.161.00	60693792	1.04.055.00	KM 26.3010.004	7.45.052.00
50513781	8.20.074.00	60694592	1.02.060.00	KM 31.2064.007	7.43.074.81
50513783	1.06.084.00	60695447	8.00.092.00	KM 31.2064.717	7.43.078.81
50513784	1.06.085.00	60695447	8.00.093.00	KM 31.2214.007	7.43.084.81
		71736430	5.04.080.00	KM 31.2814.007	7.43.060.31

KM 31.5064.027	7.43.064.41	8L0953049	2.01.125.00	6350T6	2021101028
KM 31.6614.017	7.43.086.81	8L0953049	2.01.125.12	6350T7	2024001003
KS 18.8522.002	7.44.054.20	8L0953050	2.01.124.00	6350T8	2021101027
KS 18.8560.002	7.44.050.20	8L0953050	2.01.124.12	6350T9	2025301002
KS 25.2200.007	7.44.055.00	8S0945095	1.04.206.00	6350V0	2024001002
KS 25.2600.007	7.44.054.00	8S0945096	1.04.207.00	6350Y8	5.04.093.00
KS 25.6000.507	7.44.051.00	8U0 945 093 A	1.04.146.00	6350Y9	5.04.095.00
KS 25.6400.507	7.44.050.00	8U0 945 094 A	1.04.147.00	6351CC	5.04.166.00
KS 31.3304.047	7.43.071.80	BMW	OLSA	6351JE	2021001114
KS 31.3304.057	7.43.070.80	63132492180	5.02.062.00	6351T6	2021001028
KS 31.3804.127	7.43.056.00	63133418445	5.02.071.00	6351T7	2024101003
KS 31.3804.227	7.43.057.00	63133418446	5.02.070.00	6351T8	2021001027
KS 31.3904.007	7.43.066.80	63136923919	5.02.069.00	6351T9	2025201002
KS 31.3904.017	7.43.067.80	63137164489	5.02.061.00	6351V1	2023101002
KS18.8528.002	7.44.061.20	63137165742	5.02.068.00	6351Y8	5.04.092.00
KS18.8529.002	7.44.060.20	63138370591	5.02.067.00	DAF	OLSA
KS25.2800.507	7.44.060.00	63138370592	5.02.066.00	1328860	8.94.003.00
KS25.2900.507	7.44.061.00	63210432622	5.04.242.00	1328861	8.94.002.00
KS25.6011.517	7.44.059.00	63212990109	1.04.135.00	1329718	2.42.076.00
KS25.6200.507	7.44.057.00	63212990110	1.04.134.00	1626101	2.41.116.20
KS25.6411.517	7.44.058.00	63212990113	1.04.139.00	1641742	8.94.001.00
KS25.6600.507	7.44.056.00	63212990114	1.04.138.00	1641743	8.94.000.00
T40.292.312	7.44.099.80	63212992477	1.04.137.00	1725270	8.94.005.00
T40-292-311	7.44.098.80	63212992478	1.04.136.00	1725273	8.94.004.00
AUDI	OLSA	63212992479	1.04.141.00	1835886	8.94.117.00
1P0945105D	5.06.055.00	63212992480	1.04.140.00	1835887	8.94.116.00
1P0945106D	5.06.054.00	63217164955	5.04.239.00	1875576	5.44.090.00
4D0949127D	5.02.058.00	63217164956	5.04.238.00	1875577	5.44.091.01
4F0 941 701	2020301005	63262755711	1.05.112.00	1875578	5.44.090.70
4F0 941 702	2020201005	63268372001	5.05.050.00	1875579	5.44.092.00
4G8945093H	1.04.203.00	CITROEN	OLSA	1875580	5.44.093.01
4G8945094H	1.04.202.00	630359	2.01.111.12	1875581	5.44.092.70
4G8945095H	1.04.205.00	630360	2.01.110.12	1914690	5.44.091.20
4G8945096H	1.04.204.00	632561	2.02.178.12	1914691	5.44.090.20
8E0945071	5.06.053.00	632567	2.02.180.12	FIAT	OLSA
8E0945071A	5.06.059.00	6206S7	2020001105	1562338	8.20.073.00
8E0945072	5.06.052.00	6206S9	2020001107	1562465	8.20.072.00
8E0945072A	5.06.058.00	6208S7	2020101105	2996671	68.6.622.000
8E0949127	2.02.172.12	6208S9	2020101107	2997216	68.5.631.001
8E5945073	5.06.057.00	6350CC	5.04.167.00	3800401	68.31.800
8E5945074	5.06.056.00	6350JE	2021101114	3800402	68.31.809

3800404	68.31.812	7567805	2.44.111.00	9943062	2.01.126.00
3800413	68.31.802	7569564	1.05.070.00	9943063	2.01.127.00
3800414	68.31.815	7570793	1.04.063.00	9943900	2.04.054.20
3800415	68.31.810	7570892	1.04.062.00	9943901	2.04.055.20
3800425	68.31.825	7572825	1.04.062.10	10588098	1.09.051.00
3800427	68.31.820	7572826	1.04.063.10	45628381	1.02.086.00
3800429	68.31.823	7576767	1.02.090.00	46305952	1.02.076.00
4053995	1.02.098.00	7592548	2.04.088.00	46402655	2.01.052.00
4126068	1.01.050.00	7592553	2.04.089.00	46402656	2.01.053.00
4141619	5.06.050.00	7595138	2.01.097.00	46402657	2.01.050.00
4151125	2.42.118.00	7595149	2.01.096.00	46402658	2.01.051.00
4151127	2.42.117.00	7595373	1.02.074.00	46411400	8.10.026.00
4248314	2.42.070.00	7626742	1.02.066.00	46411401	8.10.027.00
4262451	2.42.120.00	7626742	1.02.066.11	46411406	2.01.090.00
4295076	2.04.078.00	7629825	2.01.088.00	46411407	2.01.091.00
4295077	2.04.079.00	7629826	2.01.089.00	46421728	8.10.000.00
4295083	2.04.078.20	7642681	8.10.014.00	46421729	8.10.001.00
4295084	2.04.079.20	7642682	8.10.015.00	46421732	8.10.004.00
4304311	1.02.088.00	7657557	1.05.064.00	46421733	8.10.005.00
4477544	1.42.050.00	7658225	8.10.025.00	46421734	8.10.002.00
4684094	2.41.102.00	7658227	8.10.024.00	46421735	8.10.003.00
4684095	2.41.103.00	7661821	5.41.056.00	46421736	8.10.006.00
4710266	2.42.066.00	7661822	5.41.057.00	46421737	8.10.007.00
4710266	2.42.122.00	7692653	2.01.129.00	46425296	1.06.064.00
4758185	2.45.050.00	7692654	2.01.128.00	46425297	1.06.065.00
4758186	2.45.051.00	7700413	2.04.055.00	46426713	1.02.082.00
5938355	2.01.092.00	7700414	2.04.054.00	46450200	1.02.068.00
5938356	2.01.093.00	7700538	1.42.052.00	46458910	1.02.084.00
5938446	1.05.056.00	7732499	1.02.092.00	46511337	5.04.054.00
5942654	2.01.085.00	7767732	1.05.062.00	46511339	5.04.055.00
5942655	2.01.084.00	7767732	1.05.096.00	46511353	2.01.058.00
5952381	2.04.068.20	7779100	1.06.058.00	46511355	2.01.059.00
5952382	2.04.069.20	7779101	1.06.059.00	46511360	1.02.078.00
5960223	2.04.068.00	8963026	8.40.086.00	46511360	1.02.094.00
5960224	2.04.069.00	8964388	2.41.058.01	46513915	5.04.162.00
5960486	8.10.016.00	9940597	2.01.069.25	46513916	5.04.163.00
5960487	8.10.017.00	9940598	2.01.068.25	46522717	1.02.096.12
5973037	2.01.087.00	9940603	2.01.066.24	46522719	8.10.008.00
5973038	2.01.086.00	9940604	2.01.067.24	46522720	8.10.009.00
7566759	2.02.052.00	9942980	2.01.094.00	46522724	8.10.010.00
7567804	2.44.110.00	9942981	2.01.095.00	46522725	8.10.011.00

46523769	5.04.106.10	51717793	1.02.080.12	51810673	5.04.196.00
46523770	5.04.107.10	51717942	5.04.058.00	51810674	5.04.197.00
46523771	5.04.156.10	51717943	5.04.059.00	51810675	1.05.120.00
46523772	5.04.157.00	51718011	5.04.086.00	51810677	1.06.092.00
46532400	1.05.084.00	51718012	5.04.087.00	51810678	1.06.093.00
46538352	5.04.066.00	51718120	1.06.068.00	51821699	1.04.216.00
46710869	2.01.099.00	51718121	1.06.069.00	51823092	1.02.146.12
46710870	2.01.098.00	51720552	5.04.100.00	51830564	5.04.198.00
46738734	5.04.052.00	51720553	5.04.101.00	51830565	5.04.199.00
46738735	5.04.053.00	51721478	5.04.108.00	51840989	8.00.067.00
46758985	1.04.066.00	51721479	5.04.109.00	51840995	8.00.066.00
46758986	5.04.056.00	51735221	1.04.070.00	51842914	8.00.148.00
46758988	1.04.067.00	51735222	1.04.071.00	51842915	8.00.149.00
46758989	5.04.057.00	51746492	1.02.134.12	51843642	5.04.216.00
46758991	1.04.090.00	51750273	8.00.106.00	51843643	5.04.217.00
46769166	2.01.060.00	51755051	8.94.101.00	51843644	8.00.146.00
46769166	2.01.054.00	51755054	8.94.100.00	51843645	8.00.147.00
46769168	2.01.061.00	51755144	5.04.070.00	51848137	1.04.064.00
46769168	2.01.055.00	51755145	5.04.071.00	51848138	1.04.065.00
46786565	1.04.069.00	51757542	5.04.096.00	51849738	5.04.183.00
46786566	1.04.068.00	51757544	5.04.097.00	51849739	5.04.182.00
46808225	1.04.082.00	51763006	5.04.160.00	51854689	5.04.200.00
46814089	1.05.074.00	51763007	5.04.161.00	51854691	5.04.201.00
46823705	5.04.068.00	51764372	5.04.158.00	51854694	1.04.112.00
46823706	5.04.069.00	51764373	5.04.159.00	51854698	1.04.113.00
46834769	1.06.066.00	51770192	1.05.106.00	51855638	8.00.068.00
46834769	1.06.074.00	51775346	5.04.098.00	51855639	8.00.142.00
46834771	1.06.067.00	51775349	5.04.099.00	51855644	8.00.069.00
46834771	1.06.075.00	51775550	8.20.077.00	51855645	8.00.143.00
46849354	8.00.060.00	51775551	8.20.076.00	51858822	1.01.052.00
46849354	8.10.012.00	51782979	8.20.070.00	51858823	1.01.053.00
46849385	8.00.061.00	51786771	8.00.078.00	51858824	8.20.082.00
46849385	8.10.013.00	51786772	8.00.079.00	51858824	8.20.094.00
51701589	5.04.085.00	51786773	8.20.056.00	51867675	8.00.090.00
51701590	5.04.084.00	51786774	8.20.057.00	51867677	8.00.091.00
51701593	8.00.065.00	51787491	8.00.076.00	51883571	1.04.142.00
51701594	8.00.064.00	51787492	8.00.077.00	51883572	1.04.143.00
51705458	5.04.104.00	51787493	5.04.103.00	51883585	1.05.092.00
51705459	5.04.105.00	51787494	5.04.102.00	51883587	5.04.112.00
51717075	8.00.080.00	51810671	8.00.114.00	51883589	5.04.113.00
51717076	8.00.081.00	51810672	8.00.115.00	51898184	8.20.098.00

51898185	8.20.099.00	71748253	5.42.057.12	735480940	67.2323
51909639	5.04.182.19	71748254	5.42.058.12	735480941	67.2349
51909648	5.04.183.19	71748255	5.42.059.12	735480942	67.2369
51918104	1.04.152.00	77363227	1.04.071.10	735480943	67.2329
51918105	1.04.153.00	77363229	1.04.070.10	735480944	67.2307
51937405	1.01.054.00	77363281	1.04.056.10	735517038	67.2302
51937408	1.01.055.00	77363282	1.04.056.18	735517070	67.2301
51937411	1.04.186.00	77363282	1.04.060.18	735645070	67.1032.50
51937414	1.04.187.00	77363283	1.04.057.18	735645071	67.1032.01
51941875	1.06.088.00	77363283	1.04.061.18	735645076	67.1034.51
51941876	1.06.089.00	77363284	1.04.057.10	735645079	67.1033.50
51945058	1.04.150.00	77363999	1.04.060.10	735645080	67.1033.01
51945059	1.04.151.00	77364000	1.04.061.10	1301076080	1.42.054.00
51974247	5.04.252.00	82412981	1.05.068.00	1303499808	1.45.064.00
51974248	5.04.253.00	82452489	2.01.105.00	1303845080	2.05.050.00
52008634	1.04.198.00	82452490	2.01.104.00	1303845080	1.45.054.00
52008635	1.04.199.00	132635808	2.44.056.10	1303853080	2.41.108.12
52014774	1.04.218.00	132635908	2.44.057.10	1303854080	2.41.109.12
52015535	8.20.068.00	469309999	8.20.054.00	1317573080	1.46.052.00
52015967	1.04.212.00	500325883	1.45.066.00	1325618080	67.1143
52015968	1.04.213.00	735269368	1.04.102.00	1325619080	67.1144
52022739	1.04.188.00	735278919	1.04.088.00	1325620080	67.1147
52022742	1.04.189.00	735318850	67.1888	1325621080	67.1148
52071021	1.04.210.00	735318856	67.1887	1325626080	67.1141
52071022	1.04.211.00	735318908	1.44.096.00	1325627080	67.1142
52078932	1.04.208.00	735340525	1.04.084.00	1325628080	67.1146
52078933	1.04.209.00	735354549	1.08.056.00	1325629080	67.1145
60694592	1.02.070.00	735371073	1.04.104.00	1328427080	2.44.058.10
71716699	67.0400	735413383	1.08.052.00	1328427080	2.44.059.00
71716700	67.0399	735430904	1.45.068.00	1328428080	2.44.058.00
71716701	67.0384	735480886	67.2358	1328428080	2.44.059.10
71716702	67.0383	735480887	67.2310	1328430080	8.94.104.00
71748244	67.0657	735480887	70.1018.01	1328431080	8.94.105.00
71748245	67.0658	735480888	67.2348	1332946080	1.42.058.11
71748246	67.0659	735480889	67.2368	1340663080	8.40.058.00
71748247	67.0660	735480890	67.2328	1340664080	8.40.059.00
71748248	67.0661	735480933	67.2357	1344047080	2.44.206.10
71748249	67.0662	735480934	67.2309	1344047080	5.44.068.00
71748250	67.0663	735480934	70.1019.01	1344050080	2.44.207.10
71748251	67.0664	735480935	67.2347	1344050080	5.44.069.00
71748252	5.42.056.12	735480936	67.2367	1353197080	8.00.054.00

1353198080	8.00.055.00	1063835	2.02.182.11	4M51-13A603-AB	2021101026
1353205080	5.04.172.00	1065645	2.02.182.11	4M51-13A603-CB	2021101025
1353206080	5.04.173.00	1113574	2.44.050.10	5M51-13A602-AA	2021001023
1353214080	1.04.214.00	1113577	2.44.051.10	5M51-13A603-AA	2021101023
1302999080	2.44.056.00	1205546	5.42.054.00	6N11-13A602-AB	2021001031
1362912080	1.05.118.00	1205547	5.42.055.00	6N11-13A603-AB	2021101031
1367061080	8.40.088.19	1215917	2.01.118.11	6S71-13A602-EB	2021001035
1368639080	8.40.088.00	1219836	2.01.119.11	6S71-13A603-EB	2021101035
1368641080	8.40.089.00	1369220	2.44.055.10	7S71-13005-AH	2020001067
1370206080	5.44.068.19	1369221	2.44.054.10	7S71-13006-AH	2020101067
1370207080	5.44.069.19	1382999	2.45.080.00	7S71-13007-AF	2020001065
1372698080	5.44.124.00	1405019	5.02.054.12	7S71-13008-AF	2020101065
1372699080	5.44.125.00	1405020	5.02.055.12	7S71-13100-AF	2020001069
1380672080	2.44.273.10	1425136	5.02.050.12	7S71-13101-AF	2020101069
1380672080	5.44.088.00	1425141	5.02.051.12	7S71-13404-NH	2021001054
1380673080	2.44.272.10	1435880	2.44.052.10	7S71-13404-PE	2021001051
1380673080	5.44.089.00	1435881	2.44.053.10	7S71-13404-RH	2021001053
1400455380	8.00.070.00	1719704	2021001119	7S71-13405-NH	2021101054
1400455580	8.00.071.00	1719709	2021101119	7S71-13405-PE	2021101051
1474267080	8.94.172.00	1776500	70.1031.01	7S71-13405-RH	2021101053
1474268080	8.94.173.00	1805835	70.1030.01	7S71-13A602-NF	2021001052
3738200756	1.43.060.00	1847387	2.42.124.11	7S71-13A602-PF	2021001050
5801367641	68.31.806	1847390	2.42.125.11	7S71-13A603-NF	2021101052
5801552552	70.1018.50	4355478	2.02.182.12	7S71-13A603-PF	2021101050
5801552553	70.1019.50	5177810	2.44.165.00	8M51-13101-CC	2020101104
7355077620	1.08.058.00	5177813	2.44.164.00	8M51-13404-LC	2021001102
9406303537	5.41.068.00	6031704	2.02.056.00	8M51-13404-NB	2021001104
9406303547	5.41.069.00	6777877	2.01.072.00	8M51-13405-LC	2021101102
9467069888	5.04.154.00	6777878	2.01.073.00	8M51-13405-NB	2021101104
9467069988	5.04.155.00	6973445	2.05.052.00	95VG13404	2.44.048.00
9645268380	1.45.062.00	14309E	2.44.279.00	95VG13405	2.44.049.00
9680057480	1.02.148.00	14310E	2.44.278.00	9EL354667011	2021101107
9790384780	2.04.058.10	1S71-13A602-CE	2021101015	9EL354667021	2021001107
9790384780	5.04.152.00	1S71-13A603-CE	2021001015	9EL354679011	2021101105
9790384880	2.04.059.10	3M51-15K201-AB	2020201004	9EL354679021	2021001105
9790384880	5.04.153.00	3M51-15K202-AB	2020301004	9S5113A602AA	5.04.212.00
13034976670	1.48.058.00	3M5A13550-AA	5.05.052.00	9S5113A603AA	5.04.213.00
1303000080	2.44.057.00	4M51-13101-AD	2020101047	BK3117682GL5JA6	70.1028.05
FORD	OLSA 	4M51-13101-JD	2020101049	BK3117682RL5JA6	70.1026.05
1062433	2.01.070.00	4M51-13A602-AB	2021001026	BK3117683GL5JA6	70.1029.05
1062435	2.01.071.00	4M51-13A602-CB	2021001025	BK3117683RL5JA6	70.1027.05

BK3117K7746AA	70.1027.20
BM51-13404-MD	2021001118
BM51-13404-SC	2021001123
BM51-13404-TC	2021001124
BM51-13405-SC	2021101123
BM51-13405-TC	2021101124
BM51-13A602-EA	2021001121
BM51-13A602-FA	2021001122
BM51-13A602-GA	2021001117
BM51-13A602-GA	2021101117
BM51-13A603-EA	2021101121
BM51-13A603-FA	2021101122
ISUZU	OLSA <i>Parts</i>
8973768972	8.94.075.00
8973768982	8.94.074.00
8980108910	2.41.091.00
8980108920	2.41.090.00
IVECO	OLSA <i>Parts</i>
1904639	2.44.228.00
1904640	2.44.229.00
3800402	70.1021.01
3800415	70.1020.01
3801914	2.42.061.12
3801915	2.42.060.12
3801926	68.7.417.V45Q
3801928	68.7.418.V45Q
4347159	1.42.060.00
4707925	1.43.058.00
4728621	2.42.102.00
4747611	2.45.053.00
4747613	2.45.052.00
4747951	1.41.053.00
4747953	1.41.052.00
4765922	8.40.092.00
4765922	8.94.070.00
4766018	8.40.093.00
4766018	8.94.071.00
4809446	1.44.053.00
4809448	1.44.052.00
4809449	1.44.055.01
4814863	8.40.100.00

4817100	8.40.071.00
4817101	8.40.070.00
4855967	2.41.120.00
4855968	2.41.121.00
4861793	8.94.092.00
4861794	8.94.093.00
4862220	1.42.070.00
7027476	5.44.098.20
7980141	1.41.052.24
7980142	1.41.053.24
7984015	1.44.050.20
7984016	1.44.051.20
8120298	2.41.059.27
8194504	2.41.127.25
8194505	2.41.126.25
8963562	2.44.274.00
8963563	2.44.275.00
8963976	2.41.058.27
8964389	2.41.059.01
41200664	5.42.070.00
41221015	8.40.042.00
41221015	8.94.136.00
41221029	2.42.081.00
41221036	8.40.043.00
41221036	8.94.137.00
41221039	2.42.080.00
41221040	2.41.066.00
41221041	2.41.067.00
41822954	2.45.054.00
42056537	2.44.134.00
42304485	2.44.128.00
42304486	2.44.130.00
42304487	2.44.132.00
42342171	2.42.050.00
42471137	1.44.058.20
42471138	1.44.059.20
42531562	1.44.052.20
42531584	1.44.070.22
42534678	1.42.076.11
42534679	1.42.077.11
42555041	2.41.050.00



42555042	2.41.051.00
42555131	2.44.064.20
42555132	2.44.065.20
46743133	1.44.098.00
69500010	8.40.060.00
69500010	8.94.134.00
69500013	8.40.061.00
69500013	8.94.135.00
69500026	2.44.064.00
69500032	2.44.065.00
69500590	2.44.072.00
69500590	2.44.072.10
69500591	2.44.073.00
69500591	2.44.073.10
93158535	2.44.229.20
93158536	2.44.228.20
93160422	1.44.053.20
93161844	1.44.064.21
93190974	68.9.527.012
93190982	68.7.517.020
93191716	2.44.128.21
93193203	68.9.526.012
98409216	68.9.522.V25
98418078	1.43.054.00
98418080	1.43.056.00
98419234	1.42.075.00
98419235	1.42.074.00
98421202	1.44.056.00
98421203	1.44.057.00
98428489	1.44.061.00
98428491	1.44.060.00
98428493	1.44.063.01
98433912	2.41.048.00
98433913	2.41.049.00
98435942	1.44.050.00
98435944	1.44.051.00
98437475	8.94.006.00
98437476	8.94.007.00
98449181	5.41.050.00
98449182	5.41.051.00
98449391	1.45.050.00

98460036	5.41.054.00	500325709	67.1210	504063008	1.43.079.00
98460038	5.41.055.00	500325710	67.1073	504063575	1.43.078.00
98461648	1.43.073.00	500325711	67.1074	504074031	1.43.076.00
98461649	1.43.072.00	500325712	67.1207	504074032	1.43.077.00
98473011	68.9.523.V25	500325714	67.1213	504098243	2.42.090.00
99441270	2.44.168.00	500325725	67.1069	504098245	2.42.091.00
99441271	2.44.167.00	500325726	67.1070	504104465	5.41.070.00
99441272	2.44.170.00	500325729	67.1075	504104467	5.41.071.00
99441273	2.41.076.00	500325730	67.1076	504104575	1.42.065.00
99441274	2.44.171.00	500325747	67.1077	504104577	1.42.064.00
99441287	2.43.112.00	500325748	67.1078	504104580	1.42.068.00
99441302	2.43.114.00	500325751	67.1227	504104582	1.42.069.00
99441739	1.43.053.00	500328136	1.42.062.00	504150526	70.1001.02
99441740	1.43.052.00	500328137	1.42.063.00	504150527	70.1000.02
99452662	1.42.072.00	500340503	8.94.090.00	504150538	70.1003.02
99463242	2.44.138.00	500340543	8.94.091.00	504150539	70.1002.02
99463242	1.44.064.00	500340695	2.41.100.00	504150551	70.1005.02
99463243	1.44.065.00	500340696	2.41.101.00	504150552	70.1004.02
99463244	2.44.139.01	500355223	1.42.067.00	504158937	70.1001.80
99463244	1.44.067.01	500355252	1.42.066.00	504158943	70.1000.80
150324200	2.44.169.00	500356782	1.44.058.00	504158974	70.1001.20
500036581	2.43.094.80	500356783	1.44.059.00	504158976	70.1001.30
500036582	2.43.050.00	500367925	2.42.104.00	504158977	70.1000.30
500036583	2.43.051.00	500368110	1.42.076.00	504168236	67.0103
500305941	8.40.056.70	500368111	1.42.077.00	504168236	70.1032.50
500307754	8.40.066.00	500376180	1.43.064.00	504181095	8.50.058.00
500307755	8.40.067.00	504020189	8.40.044.00	504181096	8.50.060.00
500308514	5.42.050.00	504020189	8.94.008.00	504188129	8.50.058.17
500314716	1.43.075.00	504020193	8.40.045.00	504188130	8.50.059.17
500314717	1.43.074.00	504020193	8.94.009.00	504197878	68.7.524.V45
500316960	1.43.051.00	504032145	8.50.054.00	504197879	68.7.525.V45
500316961	1.43.050.00	504032145	8.94.080.00	504224428	67.0107
500319555	2.44.060.00	504032148	8.50.056.00	504224428	70.1034.50
500319555	2.44.060.10	504032148	8.94.082.00	504238093	8.94.010.00
500319556	2.44.061.00	504032814	8.40.069.00	504238117	8.94.011.00
500319556	2.44.061.10	504032815	8.40.068.00	504238203	8.94.138.00
500320425	5.41.072.00	504045133	1.43.071.00	504238213	8.94.139.00
500320426	5.41.073.00	504047264	1.43.068.00	504250958	2.42.085.00
500325706	67.1067	504047265	1.43.069.00	504250984	2.42.084.00
500325707	67.1068	504047573	2.41.054.00	504369796	70.1000.90
500325708	67.1209	504055623	1.43.070.00	504369798	70.1001.90

804158975	70.1000.20
5001021041	2.43.048.00
5801363428	1.44.101.00
5801363430	1.44.103.01
5801363431	1.44.100.00
5801363432	1.44.102.70
5801367608	70.1023.50
5801367640	70.1022.50
5801375415	8.40.090.00
5801375416	8.40.091.00
5801426889	5.44.099.00
5801426894	5.44.098.00
5801426912	5.44.099.01
5801426917	5.44.098.70
5801523220	5.44.081.00
5801523221	5.44.080.00
5801546522	1.43.080.80
5801546548	1.43.081.80
5801552552	70.1023.01
5801552553	70.1022.01
5801557592	5.44.084.00
5801557593	5.44.086.00
5801572018	2.41.094.00
5801572024	2.41.095.00
5801585146	5.41.087.00
5801585151	5.41.086.00
5801587021	8.20.100.00
5801610735	5.43.062.00
5801610737	5.43.063.00
5801637182	5.44.107.00
5801637199	5.44.105.01
5801637201	5.44.104.00
5801637202	5.44.104.70
5801745449	8.94.119.00
5801745452	8.94.118.00
5801745778	8.40.094.00
5801757326	5.44.106.70
5801757328	5.44.106.00
5801823334	2.42.068.12
5801823572	2.42.069.12
5801988398	1.48.060.80

5802031841	70.1021.50
5802031932	70.1020.50
5802055272	5.44.107.01
5802055273	5.44.103.81
5802062689	5.44.101.80
58012000568	5.44.101.81
58012000573	5.44.100.80
58012000767	5.44.100.78
58012000770	5.44.102.80
58012000772	5.44.103.80
JEEP OLSA <i>Parts</i>	
51953114	1.02.168.00
51953116	1.02.169.00
51953123	1.04.194.00
51953205	1.04.195.00
51953208	1.05.114.00
51953209	1.06.090.00
51953210	1.06.091.00
51964233	5.04.250.00
51964234	5.04.251.00
LANCIA OLSA <i>Parts</i>	
7535841	1.05.060.00
9945021	2.01.076.00
9945022	2.01.077.00
46408283	1.02.136.00
46408285	5.04.064.10
46469876	8.10.018.00
46469877	8.10.019.00
46777262	2.01.078.00
46777262	2.01.056.00
46777263	2.01.079.00
46777263	2.01.057.00
46777264	1.02.110.12
46777339	5.04.072.00
46777340	5.04.073.00
46787682	8.10.020.00
46787683	8.10.021.00
46813514	1.02.144.12
51700163	1.04.092.00
51701517	1.05.090.12
51722723	1.05.058.00



51753386	1.04.074.18
51753386	1.04.075.18
51753386	1.04.078.18
51753386	1.04.079.18
51791660	1.06.070.00
51791661	1.06.071.00
51798415	5.04.110.00
51798416	5.04.111.00
51798417	1.04.116.00
51808846	1.04.106.00
51808847	1.04.107.00
51808947	1.04.108.00
51808948	1.04.109.00
51809365	5.01.054.00
51809366	5.01.055.00
51810653	1.04.110.00
51833630	5.04.214.00
51833631	5.04.215.00
51839201	8.20.096.00
51839202	8.20.097.00
51850554	8.00.134.00
51850555	8.00.135.00
77362814	1.04.074.10
77362815	1.04.075.10
77363282	1.04.080.18
77363283	1.04.081.18
77363285	1.04.080.10
77363286	1.04.081.10
77364354	1.04.079.10
77364355	1.04.078.10
714061000	1.05.088.00
735443915	1.06.070.01
MAN OLSA <i>Parts</i>	
8252606099	2.43.132.80
81251016290	8.94.078.00
81251016291	8.94.079.00
81251016338	8.94.140.00
81251016339	8.94.141.00
81251016448	8.94.032.00
81251016449	8.94.033.00
81251016450	8.94.084.00

81251016451	8.94.085.00	0008260756	2.44.109.10	9738200521	2.41.089.00
81251016498	8.94.034.00	0008260856	2.44.108.10	9738200621	2.41.088.00
81251016499	8.94.035.00	0015401470	2.44.172.00	9738202861	8.94.029.00
81251016500	8.94.133.00	0015401770	2.44.173.01	9738202961	8.94.028.00
81251016501	8.94.132.00	0028113333	70.1009.50	001822 89 20	5.42.063.00
81251016521	8.94.073.00	0028113433	70.1008.50	001822 90 20	5.42.062.00
81251016522	8.94.072.00	0028113733	70.1009.60	001822 93 20	5.42.065.00
81252256141	2.44.125.00	0028113833	70.1008.60	A0005445411	2.42.058.80
81252256141	2.44.127.01	0035445603	2.44.185.01	A0008203564	4.44.093.00
81252256198	2.44.124.00	0035445703	2.44.184.00	A0008203664	4.44.092.00
81252256524	2.44.177.01	146491001	2.44.118.20	A0008261556	2.44.063.00
81252286010	2.44.284.00	2028200743	2.01.133.00	A0008261556	2.44.063.10
81252296055	4.44.084.20	2028200843	2.01.132.00	A0008261656	2.44.062.00
81252606101	4.42.060.80	2028201521	2.02.186.12	A0008261656	2.44.062.10
81252606104	2.42.082.80	2108200921	2.02.184.12	A0008261656	2.44.062.18
81253206084	2.41.062.00	2118200556	8.94.169.00	A0015446803	2.44.118.00
81253206088	2.42.116.00	2118200656	8.94.168.00	A0015448003	2.44.119.01
81253206091	8.50.063.00	6388200021	2.41.123.11	A00181409816	70.1025.01
81253206092	8.50.062.00	6388200121	2.41.122.11	A0018205821	4.41.055.00
81253206115	2.41.070.00	6388200821	2.41.123.12	A0018205921	4.41.054.00
81253206116	2.41.072.00	6388200921	2.41.122.12	A0018206021	4.44.095.00
7CE945095	5.44.117.00	9018200161	8.94.167.00	A0018206121	4.44.094.00
7CE945096	5.44.116.00	9018200261	8.94.166.00	A0025440690	2.44.079.00
8125225-6059	5.44.061.20	9018202461	8.94.107.00	A0025440790	2.44.081.01
8125225-6060	5.44.060.20	9018202561	8.94.106.00	A0025444790	2.44.182.20
8125225-6443	2.44.176.00	9408200056	8.94.031.00	A0025445403	2.44.182.00
8125225-6443	4.44.084.01	9408200156	8.94.030.00	A0025445503	2.44.183.01
8125225-6499	4.42.058.00	9408200161	8.94.069.00	A0025447390	2.44.276.10
8125225-6544	5.44.061.00	9408200261	8.94.068.00	A0028208256	4.44.096.00
8125225-6545	5.44.060.00	9408200321	2.41.065.00	A0028208256	4.44.097.00
8125228-6029	2.44.121.00	9408200421	2.41.064.00	A0028208656	8.94.147.00
8125228-6030	2.44.120.00	9418204361	8.94.165.00	A0028208756	8.94.146.00
8125320-6113	8.50.065.00	9418204461	8.94.164.00	A0035441003	2.44.276.70
8125320-6114	8.50.064.00	9418205361	8.94.143.00	A0035441603	2.44.276.00
MASERATI		9418205461	8.94.142.00	A0035441703	2.44.277.01
670008481	1.04.224.00	9418205561	8.94.145.00	A1248200166	2.04.093.20
670004663	1.04.226.00	9418205661	8.94.144.00	A1248200166	2.04.095.10
670004682	1.04.227.00	9418206161	8.94.175.00	A1248200266	2.04.094.10
670008482	1.04.225.00	9418206261	8.94.174.00	A1248200466	2.04.092.20
MERCEDES		9608200456	8.94.123.00	A1248260743	2.01.131.00
8201277	5.42.062.99	9608200556	8.94.122.00	A1248260843	2.01.130.00



A169 820 0521	5.02.077.00
A169 820 0621	5.02.076.00
A1713154439	5.02.092.00
A1713154440	5.02.093.00
A1718200321	5.02.091.00
A1718200421	5.02.090.00
A1769064800	1.04.221.00
A1769064900	1.04.220.00
A1769065100	1.04.222.00
A1769065300	1.04.223.00
A2018200766	2.04.091.20
A2018201466	2.04.090.20
A201820164	2.04.091.10
A201820264	2.04.090.10
A203 820 1521	5.02.083.00
A203 820 1621	5.02.082.00
A2038200121	5.02.081.00
A2038200122	5.02.080.00
A204 314 6439	5.02.085.00
A204 314 6440	5.02.084.00
A210 820 1621	5.02.088.00
A2108201521	5.02.089.00
A2453148539	5.02.079.00
A2453148540	5.02.078.00
A6398260440	5.06.069.00
A6398260540	5.06.068.00
A6708106093	70.1024.01
A9018200121	2.41.097.00
A9018200221	2.42.056.11
A9018200221	2.42.064.80
A9018202661	8.94.109.00
A9018202761	8.94.108.00
A9068200164	5.44.077.00
A9068200264	2.44.076.10
A9068200264	5.44.076.00
A9068200464	5.44.071.01
A9068200561	8.94.113.00
A9068200661	8.94.112.00
A9068201764	5.44.070.00
A9068262056	5.44.071.20
A9068262456	5.44.070.20

A9418200921	2.41.074.00
A9418201021	2.41.080.00
A9418205161	8.94.013.00
A9418205261	8.94.012.00
A9438200056	8.94.019.00
A9438200156	8.94.018.00
A9438200161	8.94.015.00
A9438200261	8.94.014.00
A9438200361	8.94.017.00
A9438200461	8.94.016.00
A9438201461	8.94.021.00
A9438201561	8.94.020.00
A9438201661	8.94.023.00
A9438201761	8.94.022.00
A9608200956	8.94.127.00
A9608201056	8.94.126.00
A9738200321	2.42.097.00
A9738200421	2.42.096.00
A9738200521	2.41.096.00
A9738200561	8.94.025.00
A9738200661	8.94.024.00
A9738202861	8.94.027.00
A9738202961	8.94.026.00
MINI	OLSA <small>Parts</small>
63137260202	1.02.164.00
51132752243	1.04.119.17
51132752244	1.04.118.17
52109806935	1.04.181.17
52109806936	1.04.180.17
63137260201	1.02.165.00
63137260203	1.02.166.00
63137260204	1.02.167.00
63212754529	1.04.129.00
63212754530	1.04.128.00
63212757009	1.04.119.00
63212757010	1.04.118.00
63212757011	1.04.121.00
63212757012	1.04.120.00
63216935783	5.04.221.00
63217166958	5.04.226.00
63217167411	1.04.127.00

63217167412	1.04.126.00
63217255909	1.04.175.00
63217255910	1.04.174.00
63217255911	1.04.177.00
63217255912	1.04.176.00
63217255915	1.04.167.00
63217255916	1.04.166.00
63217275119	1.04.171.00
63217275120	1.04.170.00
63219808149	1.04.181.00
63219808150	1.04.180.00
63242751707	1.04.125.00
63242751708	1.04.124.00
63246946904	1.04.122.00
63247255925	1.04.178.00
NISSAN	OLSA <small>Parts</small>
26124-3T900	2.41.068.10
260109X204	8.40.076.00
26010MB400	8.40.078.00
26010MB41A	8.40.080.00
260609X204	8.40.077.00
26060MB400	8.40.079.00
26060MB41A	8.40.081.00
26129-3T900	2.41.069.10
261309X100	5.41.084.00
261309X200	5.41.080.00
2613509X200	5.41.081.00
261359X100	5.41.085.00
26555-9X125	5.44.122.00
26555-9X126	5.44.123.00
8200415250	5.04.121.00
8200415251	5.04.120.00
OPEL	OLSA <small>Parts</small>
1222025	2.04.097.10
1222032	2.04.096.10
1222195	2.01.080.00
1224111	2.05.054.00
1226008	2.01.081.00
1713011	2.02.190.12
1713402	2.02.188.00
1713411	2.02.190.11

4419378	2.44.261.10
4419379	2.44.260.10
4500920	5.41.076.00
09164143	1.05.098.00
9180872	1.02.115.00
10364504	1.02.142.11
13101911	1.02.113.00
13101912	1.02.112.00
13139990	1.05.100.00
13191554	1.02.102.12
93189099	5.04.123.00
93189100	5.04.122.00
8200209522	1.44.094.00
8200416985	5.41.067.00
1EJ354676011	2020101108
1EJ354676021	2020001108
1Z0 941 702	2020201003
93.19.0306	2021101049
93.19.0307	2021001049
9EL354668021	2021001108
PEUGEOT	OLSA 
630320	2.01.113.00
630321	2.01.112.00
632528	2.02.054.00
634087	2.05.056.00
1607512580	5.02.101.12
1607512680	5.02.100.12
2VP354677011	2021101038
2VP354677021	2021001038
6350CE	2021101037
6350FH	5.04.181.00
6350FJ	5.04.179.00
6351CE	2021001037
6351FH	5.04.178.00
6351FJ	5.04.180.00
9406350Y78/6350Y7	2021101036
9406351Y78/6351Y7	2021001036
RENAULT	OLSA 
6340E9	1.05.124.00
6340G7	1.05.126.00
82849925	5.44.108.80

93854773	1.45.060.00
5000461058	5.42.078.00
5000461059	5.42.080.00
5001834559	2.41.060.00
5001834560	2.41.061.00
5001834561	5.43.060.00
5001834565	2.43.218.00
5001834565	5.43.058.00
5001840475	8.94.038.00
5001840476	8.94.039.00
5001862030	2.42.078.00
5001862030	5.43.056.00
5010231669	8.94.163.00
5010231670	8.94.162.00
5010231849	8.94.041.00
5010231850	8.94.040.00
5010578451	8.94.047.00
5010578454	8.94.043.00
5010578475	8.94.046.00
5010578478	8.94.042.00
5010623619	8.94.124.00
5010623620	8.94.125.00
7420802348	5.44.067.00
7420802350	5.44.066.00
7420802418	5.44.066.20
7425982261	5.44.109.80
7425982262	5.44.108.81
7485120619	5.42.066.12
7485120620	5.42.068.12
7485120621	5.42.069.12
7485120622	5.42.067.12
7700352700	5.44.059.00
7700352703	5.44.058.00
7700353024	1.44.068.00
7700353025	1.44.069.00
7700353184	1.46.050.00
7700820014	5.04.060.00
7701044522	5.41.063.00
7701044523	5.41.062.00
7701047516	2.02.192.12
7701349981	2.01.114.00

7701349982	2.01.115.00
8000413216	5.04.176.00
8200027150	1.02.119.12
8200027151	1.02.118.12
8200133629	5.41.064.00
8200133631	5.41.065.00
8200338148	5.04.171.00
8200338149	5.04.170.00
8200379188	1.02.116.12
8200413214	5.04.177.00
8200419908	5.04.188.00
8200439492	1.02.172.12
8200459962	5.04.131.00
8200886946	5.04.204.00
265103161R	1.05.122.00
265540003R	1.04.148.00
265800001R	1.04.185.00
265850001R	1.04.184.00
265850007R	1.04.149.00
8200013577F	1.05.110.00
ROVER	OLSA 
LR001577	2020101061
LR001573	2020101063
XFB500020	2021001045
XFB500030	2021101045
SCANIA	OLSA 
1346378	70.1014.50
1363578	4.42.052.00
1366135	70.1015.30
1366136	70.1014.30
1366141	70.1013.20
1380445	2.44.179.01
1380445	4.44.065.01
1380446	2.44.178.00
1380446	4.44.064.00
1380819	2.44.178.20
1385410	2.41.087.27
1387155	2.41.086.27
1396503	70.1015.20
1396541	70.1014.20
1422991	8.94.049.00

1422992	8.94.048.00
1443864	70.1014.60
1446353	8.94.055.00
1446354	8.94.054.00
1446355	8.94.053.00
1446356	8.94.052.00
1471599	2.42.080.80
1498102	2.44.181.01
1508176	2.44.180.00
1723518	70.1013.01
1723518	70.1015.01
1723519	70.1014.01
1732509	8.94.045.00
1732510	8.94.044.00
1747981	2.41.092.00
1756751	5.44.072.00
1756754	5.44.073.01
1760551	8.94.051.60
1760554	8.94.050.60
1770301	2.42.092.00
1792374	4.44.080.00
1792375	4.44.081.01
1798980	2.43.140.80
1931613	8.94.149.60
1931614	8.94.148.60
1949900	2.41.098.80
2160128	5.44.111.00
2340796	5.44.110.00
3175021	4.42.054.80
20557167	2.44.246.00
20557177	2.44.248.00
21735299	5.44.114.80
21735301	5.44.115.80
82483074	5.44.115.81
SEAT	OLSA Parts
1P0945105A	5.06.075.00
1P0945106A	5.06.074.00
2K0949117A	1.02.132.12
5P8.945.107 B	2021101056
5P8.945.108 B	2021001056
5P8.945.111 A	2021101046

5P8.945.112 A	2021001046
6L5945105	5.06.071.00
6L5945106	5.06.070.00
6L6945105A	5.06.073.00
6L6945106A	5.06.072.00
SETRA	OLSA Parts
A6295400645	2.42.062.80
A0005446911	2.43.052.80
SKODA	OLSA Parts
1Z0 941 701	2020301003
1Z1 941 017 P	2020101040
1Z1 941 017 Q	2020101041
1Z1 941 018 P	2020001040
1Z1 941 018 Q	2020001041
1Z5945111A	2021101019
1Z5945112A	2021001019
1Z9945105	5.06.079.00
1Z9945106	5.06.078.00
2198 2819	1.02.155.00
2198 2820	1.02.154.00
379 945 095A	1.04.161.00
3T5 945 093A	1.04.157.00
3T5 945 093B	1.04.159.00
3T5 945 094 B	1.04.158.00
3T5 945 094A	1.04.156.00
3T5 945 095A	1.04.155.00
3T5 945 096A	1.04.154.00
3T9 945 096A	1.04.160.00
3U5 945 111	2021001007
5J6 945 111	2021101047
5J6 945 112	2021001047
5J7 945 111	2021101042
5J7 945 112	2021001042
6V0949100	5.02.103.12
6V0949101	5.02.102.12
6Y6 945 111 B	2021001009
6Y6 945 112 B	2021101009
6Y9 945 111 B	2021001013
6Y9 945 111 D	2021101040
6Y9 945 112 B	2021101013
6Y9 945 112 D	2021001040

TOYOTA	OLSA Parts
8173052010	1.02.158.00
8174052010	1.02.159.00
811300D120	8.00.072.00
811700D120	8.00.073.00
815510H070	5.04.208.10
815610H070	5.04.209.10
VOLKSWAGEN	OLSA Parts
161949117	2.02.062.00
171949101	2.02.060.00
171953055	2.01.122.00
171945095AA	2.04.099.10
171945096AA	2.04.098.10
191945112A	2.04.100.10
191945112A	2.04.101.10
191953155F1	2.01.135.12
191953156C1	2.01.134.12
1H0941777	2.01.141.00
1H0941778	2.01.140.00
1H0953155A	2.01.137.12
1H0953155A	2.01.139.00
1H0953156A	2.01.136.12
1H0953156A	2.01.138.00
1J0949117	1.02.120.12
1K0949102	1.02.122.00
1K0949103	1.02.123.00
1K6945093E	5.04.065.00
1K6945094E	5.04.064.00
1K6945095E	5.04.063.00
1K6945096E	5.04.062.00
1T0949101A	5.02.099.00
1T0949102A	5.02.098.00
1Z0949101C	1.02.151.00
1Z0949102C	1.02.150.00
2D0945095	2.44.113.00
2D0945096C	2.44.112.00
2K0 941 005 B	2020101045
2K0 941 006 B	2020001045
2K0 945 095 L	2021101021
2K0 945 096 L	2021001021
2K0 945 096 M	2021001022

3B0953041B	2.01.142.12	3981456	4.44.068.00	20818763	8.94.067.00
3B0953041C	2.01.143.12	3981460	2.44.175.01	20818771	8.94.066.00
5M0945095L	5.04.135.00	3981461	2.44.174.00	20861573	8.94.061.60
5M0945096L	5.04.134.00	3981594	8.94.150.00	20861573	8.94.131.00
5N0941070	1.04.114.00	3981668	2.41.082.00	20861574	8.94.130.00
5N0941071	1.04.115.00	3981782	2.44.174.20	21035637	8.94.056.00
5N0949101E	1.02.157.00	6793924	8.94.176.00	21035637	8.94.086.00
5N0949102E	1.02.156.00	8191146	2.41.084.00	21035638	8.94.057.00
6K5953049C	2.01.101.00	11170068	2.42.108.80	21035638	8.94.087.00
6K5953050C	2.01.100.00	11170068	5.42.072.80	21035690	8.94.058.00
6N0953041B	2.01.103.00	20360273	8.94.171.00	21035692	8.94.059.00
6N0953041N	2.01.075.00	20360274	8.94.170.00	21087346	5.43.064.80
6N0953042B	2.01.102.00	20360898	8.94.063.00	21087347	5.43.066.80
6N0953042N	2.01.074.00	20360899	8.94.062.00	21221151	8.94.155.00
6Q6945095M	5.04.151.00	20398660	2.42.098.80	21221152	8.94.154.00
6Q6945095Q	5.04.149.10	20409874	2.42.053.00	21297917	8.94.064.00
6Q6945096M	5.04.150.00	20409875	2.42.052.00	21297918	8.94.065.00
6Q6945096Q	5.04.148.10	20425727	4.44.059.00	21346521	5.43.071.80
6R0945095A	5.04.211.00	20425728	2.44.293.01	21346522	5.43.070.80
6R0945096A	5.04.210.00	20425729	2.44.292.00	21735299	5.44.118.80
6R0949101F	1.02.171.12	20425729	4.44.058.00	21735301	5.44.119.80
6R0949102F	1.02.170.12	20425730	4.44.060.00	31253006	5.05.060.00
7K0949117	1.02.100.12	20425732	2.44.292.20	82114500	2.43.131.80
7L6945071	5.06.081.00	20425732	4.44.058.20	82114506	2.43.130.80
7L6945072	5.06.080.00	20455981	70.1016.01	82116545	5.43.065.80
7L6949101B	5.02.095.00	20455982	70.1017.01	82140744	8.94.153.00
7L6949101C	5.02.097.00	20455986	70.1016.50	82140763	8.94.152.00
7L6949102B	5.02.094.00	20455995	70.1016.60	82151157	5.43.069.80
7L6949102C	5.02.096.00	20565103	2.44.291.01	82151205	5.43.068.80
VOLVO	OLSA <i>Parts</i>	20565103	4.44.057.01	82483074	5.44.119.81
1063221	2.41.118.00	20565104	4.44.056.00	84122332	5.44.118.20
1371975	2.44.188.00	20565105	4.44.053.00	98433741	8.94.156.00
1371975	4.44.066.01	20565106	2.44.290.00	98433939	8.94.158.00
1387877	2.44.189.01	20565106	4.44.052.00	98433940	8.94.159.00
1387877	4.44.067.01	20565107	2.44.290.20	98433942	8.94.157.00
1446359	2.42.100.80	20565107	4.44.052.20	5802055272	5.44.107.01
1593923	2.41.125.00	20589831	70.1016.30	7422800391	5.44.108.20
1593924	2.41.124.00	20710524	8.94.061.20		
3981455	2.44.187.01	20710525	8.94.060.20		
3981455	4.44.069.01	20746401	70.1016.20		
3981456	2.44.186.00	20789440	5.42.076.80		

drawings and notes

DISEGNI E NOTE

DISEGNI DRAWINGS

2.47.092.80

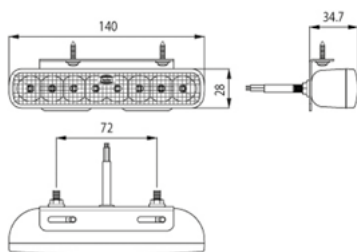

2.43.054.81-2.43.052.81

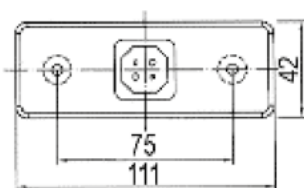

2.43.062.40-2.43.064.18

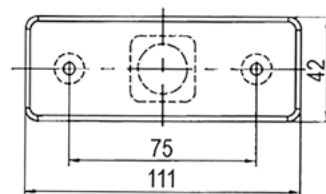

**2.47.080.80-2.47.081.80
2.47.082.80**

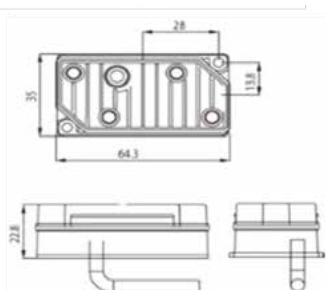

64,3x35 mm.

2.43.056.81

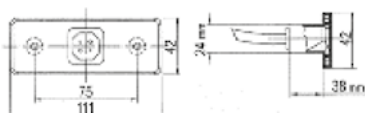

2.43.066.40-2.43.064.18

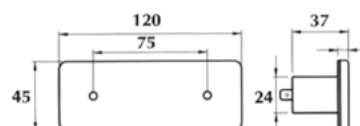

2.47.086.80

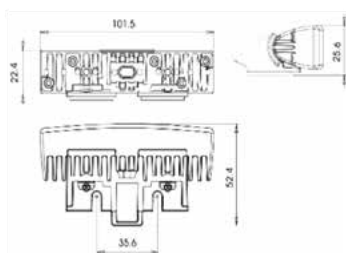

101,5x22,4 mm.

2.43.058.81-2.43.060.81

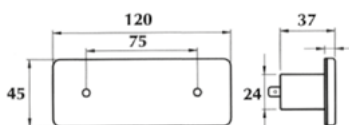

2.43.068.00-2.43.070.00

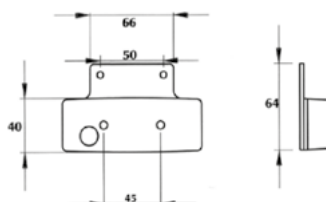

**2.47.088.80-2.47.089.80
2.47.090.80**

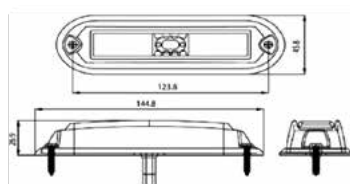

144,8x26,9 mm.

4.43.052.80

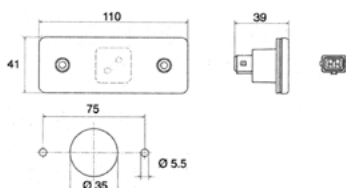

2.43.126.00

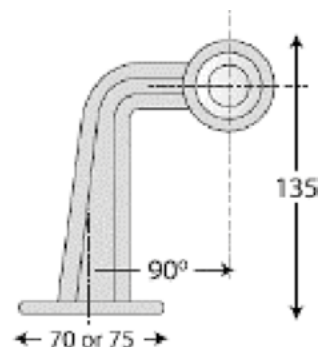

2.43.128.81-2.43.129.81

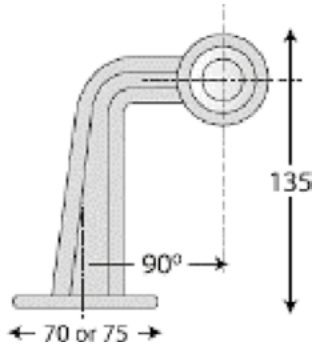

2.43.194.80

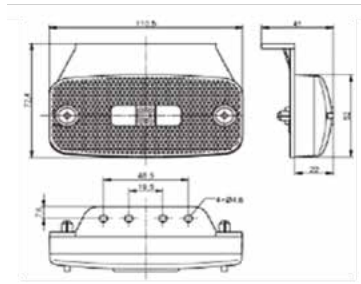

3.47.064.00

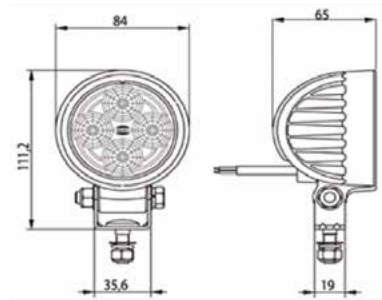

2.43.078.81-2.43.079.81

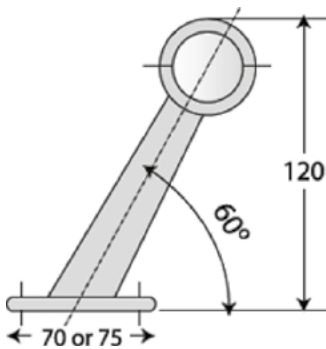

2.43.216.80

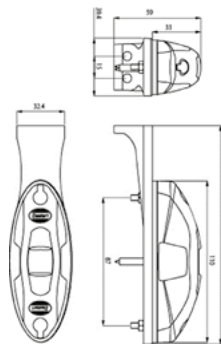

2.45.050.00-2.45.051.00

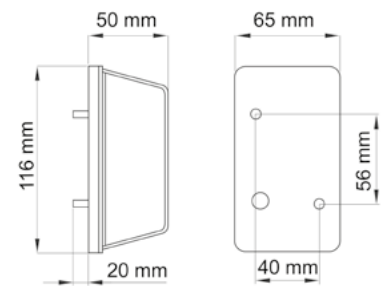

2.43.076.81-2.43.077.81

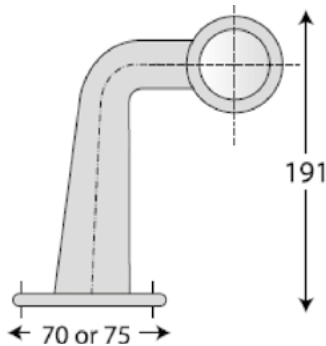

2.43.214.80

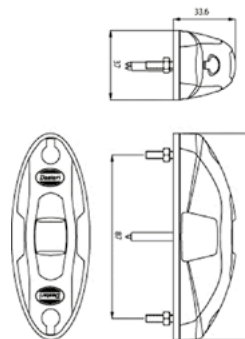

2.45.052.00-2.45.053.00

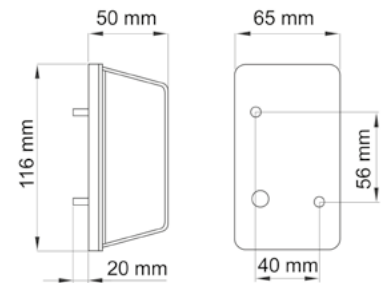

2.43.092.80-2.43.090.80

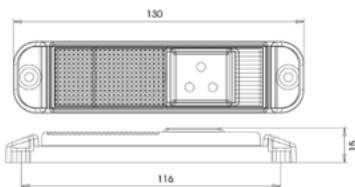

3.47.058.00

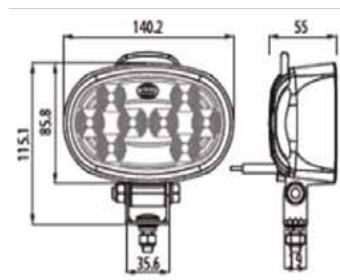

2.45.056.00-2.45.058.00

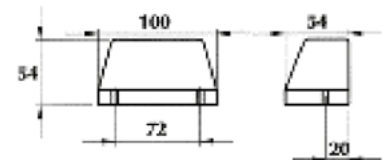

2.45.062.00-2.45.060.00

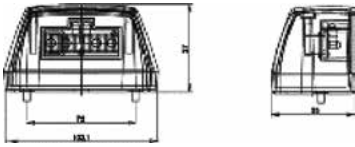

2.43.072.00

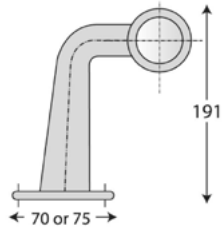

2.47.050.00-2.47.050.23

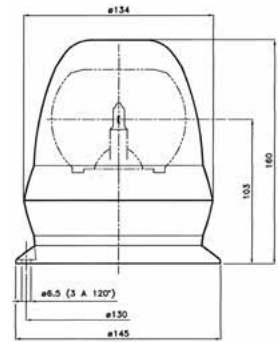

2.43.050.00

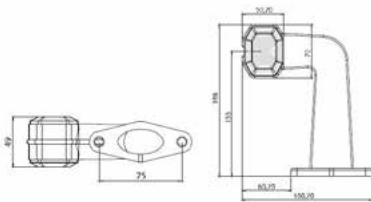

2.43.088.00

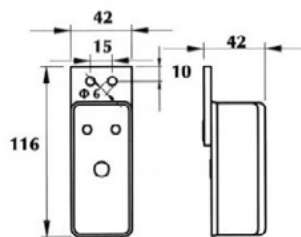

2.47.052.00-2.47.050.23

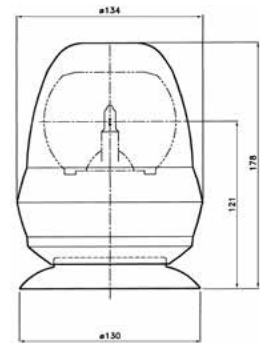

2.43.082.00

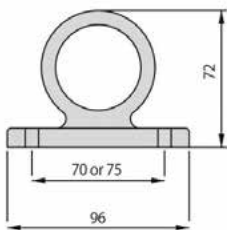

2.43.044.00

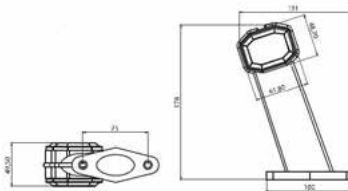

2.47.054.00-2.47.050.23

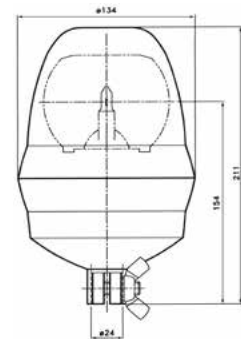

**2.43.068.00-2.43.070.00
2.43.184.00**

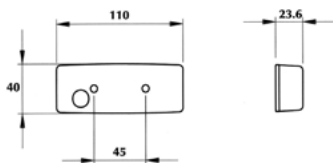

2.43.080.00

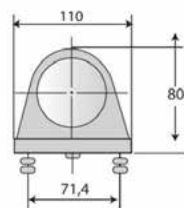

2.47.056.00-2.47.050.23

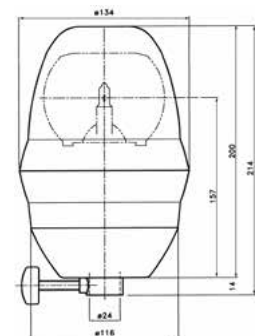

2.47.058.00-2.47.050.23

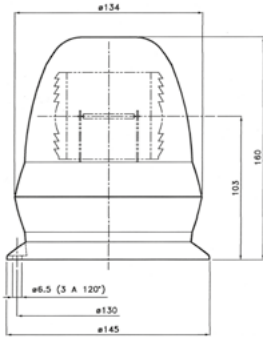

2.47.076.00-2.47.078.00

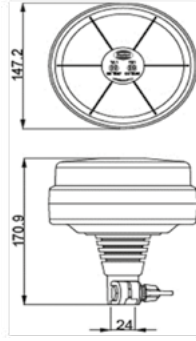

**2.47.060.00-2.47.062.00
2.47.064.00-2.47.066.00**

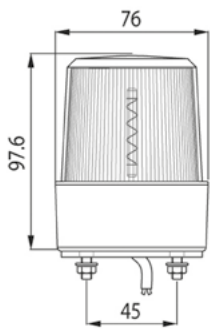

4.42.130.00

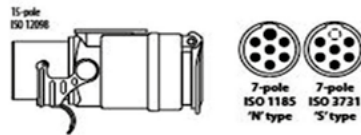

2.47.068.00-2.47.070.00

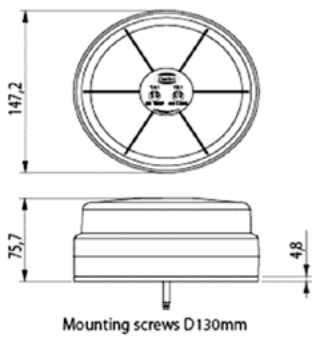

2.47.072.00-2.47.074.00

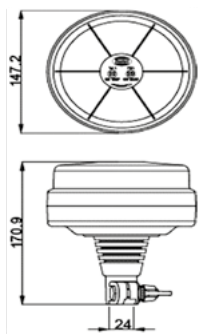

CONDIZIONI GENERALI DI VENDITA

1. Le presenti Condizioni Generali di Vendita si applicano a tutti gli ordini accettati da OLSA Parts s.r.l. (di seguito anche "OLSA") Condizioni difformi da quelle riportate saranno valide solo se redatte in forma scritta.
2. La conferma degli ordini ricevuti da OLSA potrà avvenire, entro il termine massimo di 60 giorni dalla ricezione dell'ordine medesimo, tramite accettazione tacita - cioè mediante invio diretto al cliente della merce oggetto dell'ordine - oppure tramite accettazione scritta.
3. Le condizioni di resa sono regolate secondo quanto previsto dagli accordi tra OLSA ed i suoi Clienti, e riepilogate nei documenti di trasporto emessi da OLSA.
4. Eventuali manomissioni e/o effrazioni dei colli ricevuti dovranno essere contestate direttamente al corriere, al momento del ritiro della merce.
5. Ogni reclamo inerente alla quantità della merce ricevuta o alla non corrispondenza della stessa con l'ordine dovrà esserci comunicato via PEC o raccomandata a/r entro e non oltre 8 giorni dalla data del ritiro della merce, anticipando via mail o fax tale comunicazione entro il medesimo termine in caso di raccomandata a/r. Se la differenza tra ordine e spedizione risulta essere causata da un errore di ordinazione imputabile al cliente, verrà ad esso addebitato il 20% del valore della merce resa per costi di ripristino magazzino.
6. Ogni reclamo inerente alla qualità della merce dovrà esserci trasmesso non appena riscontrato, in ogni caso non oltre la fine dell'anno solare nel quale la merce è stata ricevuta.
7. Con riferimento ai punti 5 e 6, verranno respinti resi di materiale non preventivamente autorizzati, e quindi nessuna sostituzione del materiale potrà essere effettuata se non prima concordata con i nostri uffici.
8. Per quanto riguarda i difetti soggetti alle garanzie legali di conformità, è fatto salvo quanto previsto dalla legge.
9. I prezzi di listino possono essere soggetti a variazioni e sconti anche in dipendenza di azioni promozionali ed operazioni speciali.
10. Il pagamento deve avvenire nei termini e nelle forme pattuite e per l'intero importo della fattura.
11. In caso di mancato pagamento e/o grave ritardo nell'effettuazione dello stesso, OLSA si riserva il diritto di agire in giudizio senza previa necessità di messa in mora per il recupero di quanto a lei spettante, comprensivo di ogni accessorio di legge.
12. È vietata la riproduzione, anche parziale, del contenuto del presente catalogo senza preventiva autorizzazione scritta di OLSA.
13. OLSA ha curato con particolare attenzione la stesura del presente catalogo; declina comunque ogni responsabilità per eventuali errori di immagini, disegni, corrispondenze con codici O.E. e si riserva il diritto di apportare modifiche al contenuto senza obbligo di preavviso.
14. Per qualsiasi controversia unico foro competente in via esclusiva sarà quello di Torino.

GENERAL SALES CONDITIONS TERMS

1. The following General Sale Conditions are applicable to all orders accepted by OLSA Parts s.r.l. (hereby also referred to as "OLSA"). Different conditions are deemed applicable only if in written form.
2. Confirmation of orders received by OLSA shall be made, within a maximum of 60 days from the receipt of the order, by tacit acceptance - that is, through delivery to the customer of the goods object of the order - or by written acceptance.
3. The delivery conditions are regulated in accordance with the agreements between OLSA and its customers and summarized in the transport documents issued by OLSA.
4. Tampering and/or break-ins of packages received must be challenged directly to the carrier at the time of receipt of the goods.
5. Any claim related to the quantity of the goods received or to the non-correspondence of the goods with the purchase order must be communicated via PEC or registered letter (with receipt) within 8 days from the date of receipt of goods, anticipating by e-mail or fax the notice, within the same timeframe in case of registered letter. If the difference between order and shipment results to be caused by a mistake of ordering due to the customer, OLSA will charge 20% of the value of goods delivered for costs of warehouse recovery.
6. Any complaint concerning the quality of goods must be sent when the defect is discovered, and in any case no later than the end of the calendar year in which the goods have been received.
7. With reference to paragraphs 5 and 6, returns of goods not previously authorized will be rejected, and therefore no substitution of goods shall be made if not previously agreed with our offices.
8. With regards to defects subject to legal guarantees of conformity, the governing law shall prevail.
9. Price lists can be subject to variations and discounts depending on promotional activities and special operations.
10. Payments must be made within the time limits and in the forms agreed and for the full amount of the invoices.
11. In the event of non-payment and/or delay in the payment itself, OLSA reserves the right to take legal action without the express need for formal notice for recovery of the due amount, to be inclusive of all accessories provided by the law.
12. It is forbidden to reproduce, even partially, the contents of this catalogue without prior written permission of OLSA.
13. OLSA has drafted this catalogue with the necessary required attention; OLSA declines all responsibility for any errors of images, drawings, correspondence with O.E. codes and reserves the right to make changes in the content without obligation of notification.
14. Exclusive jurisdiction for any disputes shall be the Court of Turin.



OLSA *Parts*

OLSA PARTS s.r.l.
corso Allamano, 70
10098 RIVOLI (TO) | Italia
tel. +39.011.64.74.394
fax +39.011.64.74.395
011.95.04.107
vendite@olsaparts.it
www.olsaparts.it



8 033208 058940

cod. 9.99.000.00 - omaggio