



PROIETTORI
RETROVISORI

HEADLAMPS
MIRRORS

2018





PROIETTORI - RETROVISORI 2018

HEADLAMPS - MIRRORS 2018

INDICE INDEX

PROIETTORI AUTO <i>CAR HEADLAMPS</i>	5
PROIETTORI AUTOCARRO <i>TRUCK HEADLAMPS</i>	9
RETROVISORI <i>MIRRORS</i>	31
RIFERIMENTI ORIGINALI <i>ORIGINAL PARTS NUMBERS</i>	40
INDICE PER CODICE <i>CODE INDEX</i>	42

Le marche utilizzate in questo catalogo, così come i riferimenti originali inclusi, servono unicamente per aiutare ad identificare l'articolo. Tutti i componenti citati sul presente catalogo non sono ricambi originali ma ricambi di qualità equivalente.

Trade marks used in this catalogue, as well as the genuine codes included, only attempt to help the identification of the body part. All items mentioned in this catalogue are not original spare parts but matching quality parts.

DESCRIZIONE DEI SIMBOLI

Symbol description

-  Destra | *Right*
-  Sinistra | *Left*
-  Manuale | *Manual*
-  Predisposto elettrico | *Fitted for electric*
-  Elettrico | *Electric*
-  Fendinebbia | *Fog lamp*
-  Profondità | *Depth*

Il presente catalogo si prefigge la corretta identificazione e verifica della parte di ricambio necessaria alla riparazione del veicolo ed individua i prodotti/articoli "HL" commercializzati e distribuiti da OLSA PARTS.

I prodotti commercializzati da OLSA Parts S.r.l., di cui al presente catalogo sono:

- **Ricambi di qualità equivalente**

N.B.: Ai fini del presente catalogo, per ricambi di qualità equivalente devono intendersi prodotti/articoli rispondenti alla definizione di seguito data in conformità all'attuale normativa vigente in materia.

Ai fini di una esatta individuazione della tipologia di ricambio, in calce a ciascuna pagina del presente catalogo è riportata l'espressione "ricambio di qualità equivalente".

Tale espressione deve essere intesa come riferita a tutti i prodotti/articoli graficamente presenti in ogni pagina del catalogo stesso. In particolare, per "ricambi di qualità equivalente", ai sensi e per gli effetti della definizione contenuta nel paragrafo 20, Titolo III, delle Linee Guida al Regolamento UE n. 461/2010, sostitutivo del Regolamento n. 1400/2002 (Legge Monti), si intendono "i pezzi di ricambio dotati di qualità sufficientemente elevata, in modo che il loro uso non comprometta la reputazione della rete autorizzata in questione".

Le marche citate nel presente catalogo, sono di proprietà dei costruttori dei veicoli cui si riferiscono. Il loro utilizzo nel presente catalogo, così come i riferimenti originali inclusi (cross references), hanno l'unico scopo di aiutare e agevolare l'identificazione del modello di veicolo sul quale deve montarsi il pezzo di ricambio.

This catalogue aims at properly identifying and verifying the spare parts necessary to repair the vehicle and identifies the products/items with definition "HL", commercialized and distributed by OLSA parts. The items distributed by OLSA parts srl included in this catalogue are:

- ***Matching quality parts***

N.B.: in this catalogue by matching quality parts are meant those products/items which satisfy the definition given below in accordance with the current regulation.

For an exact identification of the spare part type, at the bottom of each page of this catalogue is reported the expression "matching quality part".

That expression must be intended as referred to all products/items which are visually contained in every page of the catalogue itself. In particular, "matching quality parts", within the meaning and for the purposes of the definition contained in paragraph 20, title iii of the guidelines to the UE regulation n. 461/2010, replacing regulation n. 1400/2002 (Monti Law), mean "spare parts with sufficiently high quality, so that their use does not compromise the reputation of the authorized network in question".

Brands mentioned in this catalogue are property of the car makers which they refer to. Their use in this catalogue, as well as the OE references included, are meant only to help and to facilitate the identification of the car model which the spare parts must be fitted to.

FIAT		CINQUECENTO	
	92→98	Proiettore H4 Headlamp H4	➔ 8.10.024.00
		Proiettore H4 Headlamp H4	➔ 8.10.025.00
	*Ricambio di qualità equivalente Parts of matching quality		

FIAT		CINQUECENTO SPORTING	
	94→98	Proiettore H4 fumè Headlamp H4	➔ 8.10.026.00
		Proiettore H4 fumè Headlamp H4	➔ 8.10.027.00
	*Ricambio di qualità equivalente Parts of matching quality		

FIAT		DOBLÒ	
	05→09	Proiettore H1 + H7 Headlamp H1 + H7	➔ 8.94.098.00
		Proiettore H1 + H7 Headlamp H1 + H7	➔ 8.94.099.00
	*Ricambio di qualità equivalente Parts of matching quality		

FIAT		DOBLÒ	
	05→09	Proiettore H1 + H7 con motorino Headlamp H1 + H7 with device	➔ 8.94.100.00
		Proiettore H1 + H7 con motorino Headlamp H1 + H7 with device	➔ 8.94.101.00
	*Ricambio di qualità equivalente Parts of matching quality		

FIAT		PANDA 750	
	86→03	Proiettore ASY (R2) trasparente arancio Headlamp ASY (R2)	➔ 8.10.000.00
		Proiettore ASY (R2) trasparente arancio Headlamp ASY (R2)	➔ 8.10.001.00
	*Ricambio di qualità equivalente/Parts of matching quality		

FIAT		PANDA 750	
	86→03	Proiettore ASY (R2) trasparente arancio Headlamp ASY (R2)	➔ 8.10.002.00
		Proiettore ASY (R2) trasparente arancio Headlamp ASY (R2)	➜ 8.10.003.00
	*Ricambio di qualità equivalente Parts of matching quality		

FIAT		PANDA 750	
	95→98	Proiettore ASY (R2) trasparente incolore Headlamp ASY (R2)	➔ 8.10.004.00
		Proiettore ASY (R2) trasparente incolore Headlamp ASY (R2)	➜ 8.10.005.00
	*Ricambio di qualità equivalente Parts of matching quality		

FIAT		PANDA 750	
	95→98	Proiettore ASY (R2) trasparente incolore Headlamp ASY (R2)	➔ 8.10.006.00
		Proiettore ASY (R2) trasparente incolore Headlamp ASY (R2)	➜ 8.10.007.00
	*Ricambio di qualità equivalente Parts of matching quality		

FIAT		PANDA	
	03→09	Proiettore H4 con motorino 14 Pin Headlamp H4 with device 14 Pin	➔ 8.10.028.00
		Proiettore H4 con motorino 14 Pin Headlamp H4 with device 14 Pin	➜ 8.10.029.00
	*Ricambio di qualità equivalente Parts of matching quality		

FIAT		PANDA	
	09→12	Proiettore H4 con motorino 8 Pin Headlamp H4 with device 8 Pin	➔ 8.10.030.00
		Proiettore H4 con motorino 8 Pin Headlamp H4 with device 8 Pin	➜ 8.10.031.00
	*Ricambio di qualità equivalente Parts of matching quality		

FIAT	PUNTO		
	99→03	Proiettore H7 + H7 Headlamp H7 + H7	→ 8.10.008.00
		Proiettore H7 + H7 Headlamp H7 + H7	← 8.10.009.00
	*Ricambio di qualità equivalente Parts of matching quality		

FIAT	PUNTO		
	99→03	Proiettore H7 + H7 + H3 Headlamp H7 + H7 + H3	→ 8.10.010.00
		Proiettore H7 + H7 + H3 Headlamp H7 + H7 + H3	← 8.10.011.00
	*Ricambio di qualità equivalente Parts of matching quality		

FIAT	PUNTO		
	03→	Proiettore H1 + H7 con oscuratore Headlamp H1 + H7	→ 8.10.012.00
		Proiettore H1 + H7 con oscuratore Headlamp H1 + H7	← 8.10.013.00
	*Ricambio di qualità equivalente Parts of matching quality		

FIAT	UNO		
	89→93	Proiettore H4 Headlamp H4	→ 8.10.014.00
		Proiettore H4 Headlamp H4	← 8.10.015.00
		Proiettore ASY (R2) Headlamp ASY (R2)	→ 8.10.016.00
		Proiettore ASY (R2) Headlamp ASY (R2)	← 8.10.017.00
	*Ricambio di qualità equivalente Parts of matching quality		



**PROIETTORI
AUTOCARRO**

***TRUCK
HEADLAMPS***



DAF		CF - 95XF - 105XF	
	01→	Proiettore H1 + H7 Headlamp H1 + H7	→ 8.94.000.00
		Proiettore H1 + H7 Headlamp H1 + H7	← 8.94.001.00
	*Ricambio di qualità equivalente Parts of matching quality		

DAF		CF65-75-85 LF45-55 95 XF	
	97→02	Fendinebbia H1 + H3 Fog lamp H1 + H3	→ 8.94.002.00
		Fendinebbia H1 + H3 Fog lamp H1 + H3	← 8.94.003.00
	*Ricambio di qualità equivalente Parts of matching quality		

DAF		95XF	
	12→	Fendinebbia H3 + H3 Fog lamp H3 + H3	→ 8.94.004.00
		Fendinebbia H3 + H3 Fog lamp H3 + H3	← 8.94.005.00
	*Ricambio di qualità equivalente Parts of matching quality		

DAF		CF-XF	
	02→	Fendinebbia H11 Fog lamp H11	→ 8.94.116.00
		Fendinebbia H11 Fog lamp H11	← 8.94.117.00
	*Ricambio di qualità equivalente Parts of matching quality		

FIAT		DUCATO - JUMPER - BOXER	
	02→07	Proiettore H1 + H7 Headlamp H1 + H7	→ 8.94.104.00
		Proiettore H1 + H7 Headlamp H1 + H7	← 8.94.105.00
	*Ricambio di qualità equivalente Parts of matching quality		

FIAT		DUCATO FL (X250)	
	14→	Proiettore H7 Headlamp H7	→ 8.94.180.00
		Proiettore H7 Headlamp H7	← 8.94.181.00
	*Ricambio di qualità equivalente Parts of matching quality		

FIAT		SCUDO - JUMPER - EXPERT	
	95→03	Proiettore H4 Headlamp H4	→ 8.94.172.00
		Proiettore H4 Headlamp H4	← 8.94.173.00
	*Ricambio di qualità equivalente Parts of matching quality		

IVECO		TURBO DAILY	
	89→96	Proiettore H4 Headlamp H4	→ 8.94.156.00
		Proiettore H4 Headlamp H4	← 8.94.157.00
	*Ricambio di qualità equivalente Parts of matching quality		

IVECO		DAILY	
	96→00	Proiettore H4 Headlamp H4	→ 8.94.158.00
		Proiettore H4 Headlamp H4	← 8.94.159.00
	*Ricambio di qualità equivalente Parts of matching quality		

IVECO		DAILY	
	11→14	Proiettore H1 + H7 Headlamp H1 + H7	→ 8.94.134.00
		Proiettore H1 + H7 Headlamp H1 + H7	← 8.94.135.00
	*Ricambio di qualità equivalente Parts of matching quality		

IVECO		DAILY MY 2012	
	11→14	Proiettore H7 + H1 con motorino <i>Headlamp H7 + H1 with device</i>	→ 8.94.178.00
		Proiettore H7 + H1 con motorino <i>Headlamp H7 + H1 with device</i>	← 8.94.179.00
	*Ricambio di qualità equivalente <i>Parts of matching quality</i>		

IVECO		DAILY MY 2012	
	11→14	Fendinebbia H11 <i>Fog lamp H11</i>	→ 8.94.188.00
		Fendinebbia H11 <i>Fog lamp H11</i>	← 8.94.189.00
	*Ricambio di qualità equivalente <i>Parts of matching quality</i>		

IVECO		DAILY S 2014	
	14→	Proiettore H7 + H1 <i>Headlamp H7 + H1</i>	→ 8.94.186.00
		Proiettore H7 + H1 <i>Headlamp H7 + H1</i>	← 8.94.187.00
	*Ricambio di qualità equivalente <i>Parts of matching quality</i>		

IVECO		EUROCARGO	
	91→02	Proiettore H4 <i>Headlamp H4</i>	→ 8.94.090.00
		Proiettore H4 <i>Headlamp H4</i>	← 8.94.091.00
	*Ricambio di qualità equivalente <i>Parts of matching quality</i>		

IVECO		EUROSTAR - EUROTECH	
	93→02	Proiettore H3 + H4 <i>Headlamp H3 + H4</i>	→ 8.94.092.00
		Proiettore H3 + H4 <i>Headlamp H3 + H4</i>	← 8.94.093.00
	*Ricambio di qualità equivalente <i>Parts of matching quality</i>		

IVECO		EUROSTAR - EUROTECH	
	93→	Fendinebbia H3 + H3 <i>Fog lamp H3 + H3</i>	→ 8.94.006.00
		Fendinebbia H3 + H3 <i>Fog lamp H3 + H3</i>	← 8.94.007.00
	*Ricambio di qualità equivalente <i>Parts of matching quality</i>		

IVECO		190 TURBOSTAR	
		Proiettore 190 Turbo H4 con copertura POOT <i>Headlamp 190 Turbo H4</i>	→ 8.94.070.00
		Proiettore 190 Turbo H4 con copertura POOT <i>Headlamp 190 Turbo H4</i>	← 8.94.071.00
	*Ricambio di qualità equivalente <i>Parts of matching quality</i>		

IVECO		STRALIS	
	02→07	Proiettore H7 + H7 <i>Headlamp H7 + H7</i>	→ 8.94.008.00
		Proiettore H7 + H7 <i>Headlamp H7 + H7</i>	← 8.94.009.00
	*Ricambio di qualità equivalente <i>Parts of matching quality</i>		

IVECO		STRALIS	
	02→07	Fendinebbia H11 <i>Fog lamp H11</i>	→ 8.94.080.00
		Profondità H11 <i>Headlamp H11</i>	← 8.94.082.00
	*Ricambio di qualità equivalente <i>Parts of matching quality</i>		

IVECO		STRALIS	
	07→	Fendinebbia H11 <i>Fog lamp H11</i>	→ 8.50.058.00
		Profondità H11 <i>Headlamp H11</i>	← 8.50.060.00
	*Ricambio di qualità equivalente <i>Parts of matching quality</i>		

IVECO		STRALIS	
	07→	Proiettore H7 + H7 Headlamp H7 + H7	→ 8.94.010.00
		Proiettore H7 + H7 Headlamp H7 + H7	← 8.94.011.00
	*Ricambio di qualità equivalente Parts of matching quality		

IVECO		STRALIS	
	07→12	Proiettore H7 + H7 con motorino Headlamp H7 + H7 with device	→ 8.94.138.00
		Proiettore H7 + H7 con motorino Headlamp H7 + H7 with device	← 8.94.139.00
	*Ricambio di qualità equivalente Parts of matching quality		

IVECO		EUROCARGO - STRALIS MY 2012	
	12→	Proiettore 2H7 + luce diurna LED Headlamp 2H7 + DRL LED	→ 8.94.118.00
		Proiettore 2H7 + luce diurna LED Headlamp 2H7 + DRL LED	← 8.94.119.00
	*Ricambio di qualità equivalente Parts of matching quality		

IVECO		EUROCARGO - STRALIS	
	→12	Kit modifica proiettori H7 + H7 + luce diurna LED Conversion kit to H7 + H7 headlamps with LED DRL	→ 8.94.128.00
		Kit modifica proiettori H7 + H7 + luce diurna LED Conversion kit to H7 + H7 headlamps with LED DRL	← 8.94.129.00
	*Ricambio di qualità equivalente Parts of matching quality		

IVECO		STRALIS		LED
		Fendinebbia Daytime fog lamp external	→	8.90.050.60
		Fendinebbia Daytime fog lamp inner	←	
	*Ricambio di qualità equivalente Parts of matching quality			

ISUZU		NPR	
	08→	Proiettore H4 Headlamp H4	→ 8.94.074.00
		Proiettore H4 Headlamp H4	← 8.94.075.00
	*Ricambio di qualità equivalente Parts of matching quality		

MAN		TGA	
	99→06	Proiettore H7 + H7 Headlamp H7 + H7	→ 8.94.032.00
		Proiettore H7 + H7 Headlamp H7 + H7	← 8.94.033.00
	*Ricambio di qualità equivalente Parts of matching quality		

MAN		TGA	
	99→06	Proiettore H7 + H7 Headlamp H7 + H7	→ 8.94.084.00
		Proiettore H7 + H7 Headlamp H7 + H7	← 8.94.085.00
	*Ricambio di qualità equivalente Parts of matching quality		

MAN		F 2000	
	94→	Proiettore F2000 2H7 Headlamp F2000 2H7	→ 8.94.078.00
		Proiettore F2000 2H7 Headlamp F2000 2H7	← 8.94.079.00
	*Ricambio di qualità equivalente Parts of matching quality		

MAN		F 2000	
	95→02	Fendinebbia 2H3 Fog lamp 2H3	→ 8.94.140.00
		Fendinebbia 2H3 Fog lamp 2H3	← 8.94.141.00
	*Ricambio di qualità equivalente Parts of matching quality		

MAN		TGX	
	00→06	Proiettore H7 + H7 Headlamp H7 + H7	→ 8.94.034.00
		Proiettore H7 + H7 Headlamp H7 + H7	← 8.94.035.00
	*Ricambio di qualità equivalente Parts of matching quality		

MAN		TGX	
	08→	Proiettore 2H7 + DRL Headlamp 2H7 + DRL	→ 8.94.132.00
		Proiettore 2H7 + DRL Headlamp 2H7 + DRL	← 8.94.133.00
	PY21W+H21W+LED CON DRL *Ricambio di qualità equivalente Parts of matching quality		

MAN		TGX	
	00→06	Fendinebbia H3 + H4 Fog lamp H3 + H4	→ 8.94.072.00
		Fendinebbia H3 + H4 Fog lamp H3 + H4	← 8.94.073.00
	*Ricambio di qualità equivalente Parts of matching quality		

MERCEDES		ACTROS	
	93→03	Proiettore H4 Headlamp H4	→ 8.94.142.00
		Proiettore H4 Headlamp H4	← 8.94.143.00
	*Ricambio di qualità equivalente Parts of matching quality		

MERCEDES		ACTROS	
	93→03	Proiettore Headlamp	→ 8.94.144.00
		Proiettore Headlamp	← 8.94.145.00
	*Ricambio di qualità equivalente Parts of matching quality		

MERCEDES		ACTROS	
	93→03	Fendinebbia H3 <i>Fog lamp H3</i>	→ 8.94.146.00
		Fendinebbia H3 <i>Fog lamp H3</i>	← 8.94.147.00
	*Ricambio di qualità equivalente <i>Parts of matching quality</i>		

MERCEDES		ACTROS MP 1	
	93→03	Proiettore H4 + H3 <i>Headlamp H4 + H3</i>	→ 8.94.012.00
		Proiettore H4 + H3 <i>Headlamp H4 + H3</i>	← 8.94.013.00
	*Ricambio di qualità equivalente <i>Parts of matching quality</i>		

MERCEDES		ACTROS	
	96→02	Proiettore H1 + H4 con motorino <i>Headlamp H1 + H4 with device</i>	→ 8.94.174.00
		Proiettore H1 + H4 con motorino <i>Headlamp H1 + H4 with device</i>	← 8.94.175.00
	*Ricambio di qualità equivalente <i>Parts of matching quality</i>		

MERCEDES		ACTROS	
	96→02	Proiettore H1 + H4 con motorino <i>Headlamp H1 + H4 with device</i>	→ 8.94.164.00
		Proiettore H1 + H4 con motorino <i>Headlamp H1 + H4 with device</i>	← 8.94.165.00
	*Ricambio di qualità equivalente <i>Parts of matching quality</i>		

MERCEDES		ACTROS MP 2	
	03→09	Proiettore H1 + H7 <i>Headlamp H1 + H7</i>	→ 8.94.014.00
		Proiettore H1 + H7 <i>Headlamp H1 + H7</i>	← 8.94.015.00
	*Ricambio di qualità equivalente <i>Parts of matching quality</i>		

MERCEDES		ACTROS MP 2	
	03→09	Proiettore H1 + H7 con motorino <i>Headlamp H1 + H7 with device</i>	→ 8.94.016.00
		Proiettore H1 + H7 con motorino <i>Headlamp H1 + H7 with device</i>	← 8.94.017.00
	*Ricambio di qualità equivalente <i>Parts of matching quality</i>		

MERCEDES		ACTROS MP 2	
	→09	Fendinebbia H3 <i>Fog lamp H3</i>	→ 8.94.018.00
		Fendinebbia H3 <i>Fog lamp H3</i>	← 8.94.019.00
	*Ricambio di qualità equivalente <i>Parts of matching quality</i>		

MERCEDES		ACTROS MP 3	
	08→	Proiettore H7 + H1 <i>Headlamp H7 + H1</i>	→ 8.94.020.00
		Proiettore H7 + H1 <i>Headlamp H7 + H1</i>	← 8.94.021.00
	*Ricambio di qualità equivalente <i>Parts of matching quality</i>		

MERCEDES		ACTROS MP 3	
	08→	Proiettore H7 + H1 <i>Headlamp H7 + H1</i>	→ 8.94.022.00
		Proiettore H7 + H1 <i>Headlamp H7 + H1</i>	← 8.94.023.00
	*Ricambio di qualità equivalente <i>Parts of matching quality</i>		

MERCEDES		ACTROS - AXOR	
	08→	Fendinebbia H1 <i>Fog lamp H1</i>	→ 8.94.030.00
		Fendinebbia H1 <i>Fog lamp H1</i>	← 8.94.031.00
	*Ricambio di qualità equivalente <i>Parts of matching quality</i>		

MERCEDES		ATEGO	
	98→04	Proiettore H1 + H4 Headlamp H1 + H4	→ 8.94.024.00
		Proiettore H1 + H4 Headlamp H1 + H4	← 8.94.025.00
	*Ricambio di qualità equivalente Parts of matching quality		

MERCEDES		ATEGO	
	04→	Proiettore H7 + 2H1 con fendinebbia Headlamp H7 + 2H1 with fog lamp	→ 8.94.026.00
		Proiettore H7 + 2H1 con fendinebbia Headlamp H7 + 2H1 with fog lamp	← 8.94.027.00
	*Ricambio di qualità equivalente Parts of matching quality		

MERCEDES		ATEGO	
	05→	Proiettore H7 + 2H1 con motorino e fendinebbia Headlamp H7 + 2H1 with device and fog lamp	→ 8.94.028.00
		Proiettore H7 + 2H1 con motorino e fendinebbia Headlamp H7 + 2H1 with device and fog lamp	← 8.94.029.00
	*Ricambio di qualità equivalente Parts of matching quality		

MERCEDES		AXOR	
	05→	Proiettore H7 + H1 Headlamp H7 + H1	→ 8.94.068.00
		Proiettore H7 + H1 Headlamp H7 + H1	← 8.94.069.00
	*Ricambio di qualità equivalente Parts of matching quality		

MERCEDES		AXOR MP II	
	05→12	Proiettore H7 + H1 con motorino Headlamp H7 + H1 with device	→ 8.94.184.00
		Proiettore H7 + H1 con motorino Headlamp H7 + H1 with device	← 8.94.185.00
	Completo di mascherina e fanale With grill and lamp *Ricambio di qualità equivalente Parts of matching quality		

MERCEDES	ACTROS	LED
	08→ Fendinebbia LED LED daytime fog lamp	→ 8.90.054.60
	→12 Fendinebbia LED LED daytime fog lamp	← 8.90.055.60
	*Ricambio di qualità equivalente Parts of matching quality	

MERCEDES	ACTROS	LED
	→12 Fendinebbia Fog lamp	→ 8.94.122.00
	→12 Fendinebbia Fog lamp	← 8.94.123.00
	*Ricambio di qualità equivalente Parts of matching quality	

MERCEDES	ACTROS	LED
	→12 Luce di marcia diurna LED DRL LED	→ 8.94.126.00
	→12 Luce di marcia diurna LED DRL LED	← 8.94.127.00
	*Ricambio di qualità equivalente Parts of matching quality	

MERCEDES	SPRINTER	LED
	95→01 Proiettore H1 + H1 Headlamp H1 + H1	→ 8.94.166.00
	95→01 Proiettore H1 + H1 Headlamp H1 + H1	← 8.94.167.00
	*Ricambio di qualità equivalente Parts of matching quality	

MERCEDES	SPRINTER	LED
	03→06 Proiettore H3 + 2H7 Headlamp H3 + 2H7	→ 8.94.106.00
	03→06 Proiettore H3 + 2H7 Headlamp H3 + 2H7	← 8.94.107.00
	*Ricambio di qualità equivalente Parts of matching quality	

MERCEDES		SPRINTER	
	03→06	Proiettore H3 + 2H7 con motorino <i>Headlamp H3 + 2H7 with device</i>	→ 8.94.108.00
		Proiettore H3 + 2H7 con motorino <i>Headlamp H3 + 2H7 with device</i>	← 8.94.109.00
	*Ricambio di qualità equivalente <i>Parts of matching quality</i>		

MERCEDES		SPRINTER	
	07→	Proiettore 3H7 <i>Headlamp 3H7</i>	→ 8.94.110.00
		Proiettore 3H7 <i>Headlamp 3H7</i>	← 8.94.111.00
	*Ricambio di qualità equivalente <i>Parts of matching quality</i>		

MERCEDES		SPRINTER	
	07→0	Proiettore 3H7 con motorino <i>Headlamp 3H7 with device</i>	→ 8.94.112.00
		Proiettore 3H7 con motorino <i>Headlamp 3H7 with device</i>	← 8.94.113.00
	*Ricambio di qualità equivalente <i>Parts of matching quality</i>		

MERCEDES		SPRINTER	
	06→	Fendinebbia H1 <i>Fog lamp H1</i>	→ 8.94.168.00
		Fendinebbia H1 <i>Fog lamp H1</i>	← 8.94.169.00
	*Ricambio di qualità equivalente <i>Parts of matching quality</i>		

RENAULT		PREMIUM	
	01→07	Proiettore 2H1 <i>Headlamp 2H1</i>	→ 8.94.038.00
		Proiettore 2H1 <i>Headlamp 2H1</i>	← 8.94.039.00
	*Ricambio di qualità equivalente <i>Parts of matching quality</i>		

RENAULT		PREMIUM MIDLUM KERAX		
	01→07	Proiettore H1 + H1 Headlamp H1 + H1	→	8.94.162.00
		Proiettore H1 + H1 Headlamp H1 + H1	←	8.94.163.00
	Completo di fanale e cornice <i>With frame and lamp</i>		*Ricambio di qualità equivalente <i>Parts of matching quality</i>	

RENAULT		PREMIUM		
	00→06	Fendinebbia H1 + H1 Fog lamp H1 + H1	→	8.94.040.00
		Fendinebbia H1 + H1 Fog lamp H1 + H1	←	8.94.041.00
	*Ricambio di qualità equivalente <i>Parts of matching quality</i>			

RENAULT		PREMIUM		LED
	06→	Fendinebbia Fog lamp	→	8.90.056.60
		Fendinebbia Fog lamp	←	8.90.057.60
	*Ricambio di qualità equivalente <i>Parts of matching quality</i>			

RENAULT		NEW PREMIUM		
	06→	Proiettore H1 + H7 + H3 Headlamp H1 + H7 + H3	→	8.94.042.00
		Proiettore H1 + H7 + H3 Headlamp H1 + H7 + H3	←	8.94.043.00
	Parabola nera <i>Black reflector</i>		*Ricambio di qualità equivalente <i>Parts of matching quality</i>	

RENAULT		NEW PREMIUM	
	06→	Proiettore H1 + H7 + H3 Headlamp H1 + H7 + H3	→ 8.94.046.00
		Proiettore H1 + H7 + H3 Headlamp H1 + H7 + H3	← 8.94.047.00
	Parabola metallizzata Metalized reflector *Ricambio di qualità equivalente Parts of matching quality		

RENAULT		MAGNUM	
	08→	Fendinebbia H1 Fog lamp H1	8.94.088.00
		*Ricambio di qualità equivalente Parts of matching quality	

RENAULT		MAGNUM	
	01→	Proiettore H7 + H1 Headlamp H7 + H1	→ 8.94.124.00
		Proiettore H7 + H1 Headlamp H7 + H1	← 8.94.125.00
	*Ricambio di qualità equivalente Parts of matching quality		

SCANIA		CR 114-124-144-164	
	00→06	Proiettore H4 con gruppo ottico Headlamp H4 with optical unit	→ 8.94.044.00
		Proiettore H4 con gruppo ottico Headlamp H4 with optical unit	← 8.94.045.00
	*Ricambio di qualità equivalente Parts of matching quality		

SCANIA		CR 114-124-144-164	
	00→06	Fendinebbia H1 + H1 Fog lamp H1 + H1	→ 8.94.048.00
		Fendinebbia H1 + H1 Fog lamp H1 + H1	← 8.94.049.00
	*Ricambio di qualità equivalente Parts of matching quality		

SCANIA	CR 114-124-144-164	LED
	Fendinebbia <i>LED Daytime running fog light</i>	→ 8.90.058.60
	Fendinebbia <i>LED Daytime running fog light</i>	← 8.90.059.60
	*Ricambio di qualità equivalente <i>Parts of matching quality</i>	

SCANIA	P-R-T	LED
	Luce diurna LED <i>DRL LED</i>	→ 8.94.148.60
	09→ Luce diurna LED <i>DRL LED</i>	← 8.94.149.60
	*Ricambio di qualità equivalente <i>Parts of matching quality</i>	

SCANIA	R	XENON
	Proiettore xenon H7 con centralina <i>Xenon headlamp H7</i>	→ 8.94.050.60
	00→06 Proiettore xenon H7 con centralina <i>Xenon headlamp H7</i>	← 8.94.051.60
	*Ricambio di qualità equivalente <i>Parts of matching quality</i>	

SCANIA	R	
	Proiettore H1 + H7 con motorino <i>Headlamp H1 + H7 with device</i>	→ 8.94.050.00
	00→06 Proiettore H1 + H7 con motorino <i>Headlamp H1 + H7 with device</i>	← 8.94.051.00
	*Ricambio di qualità equivalente <i>Parts of matching quality</i>	

SCANIA	R	
	Fendinebbia H1 esterno <i>Fog lamp H1 external</i>	→ 8.94.052.00
	00→06 Fendinebbia H1 esterno <i>Fog lamp H1 external</i>	← 8.94.053.00
	*Ricambio di qualità equivalente <i>Parts of matching quality</i>	

SCANIA		R	
	00→06	Fendinebbia H1 interno <i>Fog lamp H1 inner</i>	→ 8.94.054.00
		Fendinebbia H1 interno <i>Fog lamp H1 inner</i>	← 8.94.055.00
	*Ricambio di qualità equivalente <i>Parts of matching quality</i>		

SCANIA		R	LED
		Fendinebbia esterno <i>LED daytime running fog lamp external</i>	→ 8.90.060.60
		Fendinebbia esterno <i>LED daytime running fog lamp external</i>	← 8.90.061.60
	*Ricambio di qualità equivalente <i>Parts of matching quality</i>		

SCANIA		R	LED
		Fendinebbia interno <i>LED fog lamp inner</i>	→ 8.90.066.60
		Fendinebbia interno <i>LED fog lamp inner</i>	← 8.90.067.60
	*Ricambio di qualità equivalente <i>Parts of matching quality</i>		

VOLVO		F - FL - FS	
	85→97	Proiettore H4 <i>Headlamp H4</i>	→ 8.94.176.00
			←
	*Ricambio di qualità equivalente <i>Parts of matching quality</i>		

VOLVO		FH 12 - FH 16	
	93→01	Fendinebbia H3 con fissaggio a scatto <i>Fog lamp H3</i>	→ 8.94.170.00
		Fendinebbia H3 con fissaggio a scatto <i>Fog lamp H3</i>	← 8.94.171.00
	*Ricambio di qualità equivalente <i>Parts of matching quality</i>		

VOLVO		FH 12		
	97→01	Proiettore H4 <i>Headlamp H4</i>	→ ←	8.94.150.00
		*Ricambio di qualità equivalente <i>Parts of matching quality</i>		

VOLVO		FH 2008		LED
	08→	Proiettore H7 + H7 con motorino + DRL <i>Headlamp H7 + H7 with device + DRL</i>	→	8.94.056.00
		Proiettore H7 + H7 con motorino + DRL <i>Headlamp H7 + H7 with device + DRL</i>	←	8.94.057.00
		*Ricambio di qualità equivalente <i>Parts of matching quality</i>		

VOLVO		FH 2008		LED
	08→	Proiettore H7 + H7 con motorino + DRL <i>Headlamp H7 + H7 with device + DRL</i>	→	8.94.086.00
		Proiettore H7 + H7 con motorino + DRL <i>Headlamp H7 + H7 with device + DRL</i>	←	8.94.087.00
		*Ricambio di qualità equivalente <i>Parts of matching quality</i>		

VOLVO		FH		
	08→	Fendinebbia H3 <i>Fog lamp H3</i>	→	8.94.058.00
		Fendinebbia H3 <i>Fog lamp H3</i>	←	8.94.059.00
		*Ricambio di qualità equivalente <i>Parts of matching quality</i>		

VOLVO		FH		
	08→	Fendinebbia H3 + H3 <i>Fog lamp H3 + H3</i>	→	8.94.064.00
		Fendinebbia H3 + H3 <i>Fog lamp H3 + H3</i>	←	8.94.065.00
		*Ricambio di qualità equivalente <i>Parts of matching quality</i>		

VOLVO		FH	
	14→	Fendinebbia cromato <i>Fog lamp</i>	→ 8.94.152.00
		Fendinebbia cromato <i>Fog lamp</i>	← 8.94.153.00
	*Ricambio di qualità equivalente Parts of matching quality		

VOLVO		FM	
	14→	Fendinebbia <i>Fog lamp</i>	→ 8.94.154.00
		Fendinebbia <i>Fog lamp</i>	← 8.94.155.00
	*Ricambio di qualità equivalente Parts of matching quality		

VOLVO		FH VERSION 2		XENON	
	03→08	Proiettore xenon D2S + 2H7 con centralina - connettore rettangolare <i>Headlamp xenon D2S + 2H7 rectangular connector</i>	→	8.94.060.60	
		Proiettore xenon D2S + 2H7 con centralina - connettore rettangolare <i>Headlamp xenon D2S + 2H7 rectangular connector</i>	←	8.94.061.60	
		Vetro proiettore <i>Headlamp</i>	→	8.94.060.20	
		Vetro proiettore <i>Headlamp</i>	←	8.94.061.20	
		Adattatore da rettangolare a tondo <i>Adapter from rectangular to round</i>			8.94.062.19
*Ricambio di qualità equivalente Parts of matching quality					
	→12	Centralina controllo xenon <i>Xenon control [centralina]</i>		8.94.060.66	
	93→01	Kit 2 lampade per Volvo xenon <i>2 headlamps kit for Volvo xenon</i>		8.94.060.68	
*Ricambio di qualità equivalente Parts of matching quality					

VOLVO		FH VERSION 2	
	03→08	Proiettore 4H7 connettore rettangolare <i>Headlamp 4H7 rectangular connector</i>	→ 8.94.062.00
		Proiettore 4H7 connettore rettangolare <i>Headlamp 4H7 rectangular connector</i>	← 8.94.063.00
		Vetro proiettore <i>Headlamp</i>	→ 8.94.060.20
		Vetro proiettore <i>Headlamp</i>	← 8.94.061.20
		Adattatore da rettangolare a tondo <i>Adapter from rectangular to round</i>	8.94.062.19
*Ricambio di qualità equivalente <i>Parts of matching quality</i>			

VOLVO		FH	
	03→08	Proiettore 4H7 connettore rotondo <i>Headlamp 4H7 circle connector</i>	→ 8.94.130.00
		Proiettore 4H7 connettore rotondo <i>Headlamp 4H7 circle connector</i>	← 8.94.131.00
		*Ricambio di qualità equivalente <i>Parts of matching quality</i>	

VOLVO		FH 2		LED	
	03→08	Fendinebbia <i>LED daytime running fog light</i>	→ 8.90.068.60		
		Fendinebbia <i>LED daytime running fog light</i>	← 8.90.069.60		
		*Ricambio di qualità equivalente <i>Parts of matching quality</i>			

VOLVO		FH VERSION 2 - FE - FL	
	03→08	Proiettore H4 <i>Headlamp H4</i>	→ 8.94.066.00
		Proiettore H4 <i>Headlamp H4</i>	← 8.94.067.00
		*Ricambio di qualità equivalente <i>Parts of matching quality</i>	

UNIVERSALE

Faro ausiliario H7
Auxiliary light H7

Ø 1900mm

8.10.022.00

***Ricambio di qualità equivalente | Parts of matching quality**

LAMPADE A LED **H7**

12/24V

cod. 24100



LAMPADE A LED **H4**

12/24V

cod. 24200



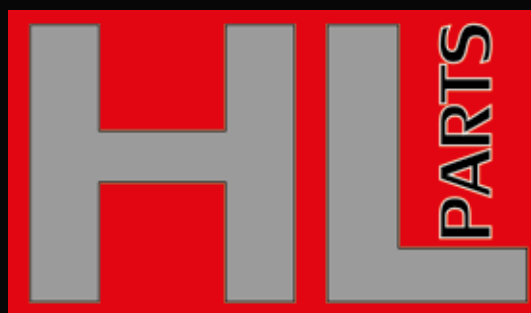























RETROVISORI

MIRRORS





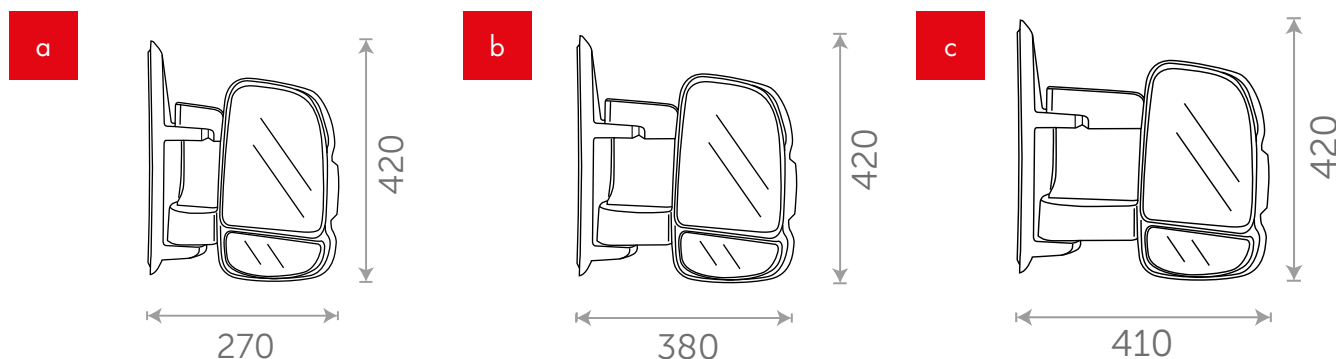

DESCRIZIONE DEI SIMBOLI *Symbol description*

-  Specchio completo | *Complete mirror*
-  Vetro con supporto plastico | *Glass unit*
-  Calotta | *Back cover*
-  Regolazione elettrica | *Electrically operated, remote controlled*
-  Regolazione manuale | *Manually adjustable*
-  Riscaldato 12V | *Heated 12V*
-  Riscaldato 24V | *Heated 24V*
-  Raggio di curvatura dello specchio | *Radius of mirror glass*
-  Raggio di curvatura dello specchio | *Radius of mirror glass*
-  Per veicoli con guida a sinistra/destra | *For left/right hand driven vehicles*
-  Per veicoli con guida a sinistra | *For left hand driven vehicles*
-  Per applicazione a sinistra/destra | *Applicable for left/right hand side*
-  Per applicazione destra | *Applicable for right hand side*
-  Per applicazione sinistra | *Applicable for left hand side*
-  Braccio destro corto | *Right short arm*
-  Braccio sinistro corto | *Left short arm*
-  Braccio destro medio | *Right medium arm*
-  Braccio sinistro medio | *Left medium arm*
-  Braccio destro lungo | *Right long arm*
-  Braccio sinistro lungo | *Left long arm*
-  Cablaggio per retrovisori | *Wiring for rear-view mirrors*
-  Specchio ripiegabile elettricamente | *Electrically retractable mirror*
-  Con sonda | *With sonde*





				ECE		300		1200	
	a	70.1018.50							
	a	70.1019.50							
	a	70.1018.01							
	a	70.1019.01							
	b	70.1036.50							
	b	70.1037.50							
	b	70.1036.01							
	b	70.1037.01							
	c	70.1038.50							
	c	70.1039.50							
	c	70.1038.01							
	c	70.1039.01							
	1	1	70.1018.40						
1		70.1019.40							
2		70.1018.60							
2		70.1019.60							
*Ricambio di qualità equivalente <i>Parts of matching quality</i>									



FORD
TRANSIT V362
12→

		ECE		300	1200
 1  2  3 		70.1030.01			
		70.1031.01			
	1	70.1030.50			
	1	70.1031.50			
	2	70.1030.30			
	2	70.1031.30			
	3	70.1030.20			
	3	70.1031.20			

FORD
TRANSIT V363
14→

		ECE		300	1200	
 1  2  3 		70.1026.05				
		70.1027.05				
	1	70.1026.50				
	1	70.1027.50				
	2	70.1026.30				
	2	70.1027.30				
	3	70.1026.20				
	3	70.1027.20				

		ECE		300		1200	
 1 2 3		70.1028.05					
		70.1029.05					
	1	70.1026.50					
	1	70.1027.50					
	2	70.1026.30					
	2	70.1027.30					
	3	70.1026.20					
	3	70.1027.20					

		ECE		300		1200		
 1  2  3 	a	70.1020.50						
	a	70.1021.50						
	a	70.1020.01						
	a	70.1021.01						
	b	70.1040.50						
	b	70.1041.50						
	b	70.1040.01						
	b	70.1041.01						
	1	70.1020.40						
	1	70.1021.40						
	2	70.1020.60						
	2	70.1021.60						
	3	70.1020.19		(06→09)				

*Ricambio di qualità equivalente | *Parts of matching quality*

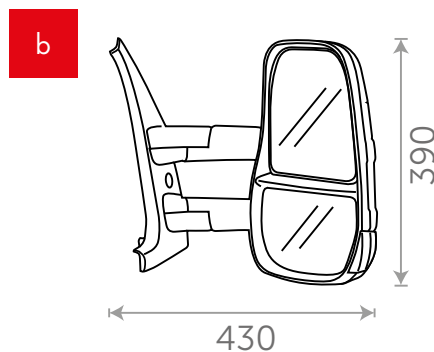
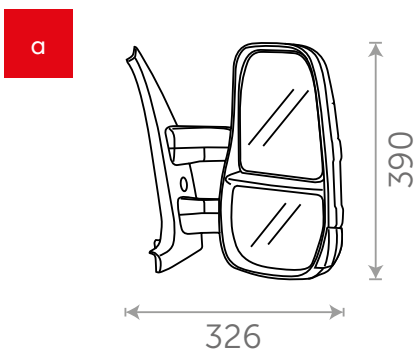

IVECO

DAILY 2012

12→

	70.1022.50	
	70.1023.50	
	70.1022.01	
	70.1023.01	
* Ricambio di qualità equivalente Parts of matching quality		

IVECO

STRALIS

07→

	70.1032.50	<i>guardaruota</i>

IVECO

STRALIS

07→

	70.1034.50	<i>guarda avanti</i>

				ECE		300		1200				
	a	70.1000.02									mm 799x370x272	
	a	70.1001.02									mm 799x370x272	
	b	70.1002.02									mm 799x424x287	
	b	70.1003.02									mm 799x424x287	
	c	70.1004.02									mm 811x520x304	
	c	70.1005.02									mm 811x520x304	
	1	70.1000.20										mm 388x242
	1	70.1001.20										mm 388x242
	2	70.1000.30										mm 242x226
	2	70.1001.30										mm 242x226
	3	68.7.524.V45										mm 371x181
	4	68.7.525.V45										mm 192x206
5	70.1000.80											
5	70.1001.80											
6	70.1000.90											
6	70.1001.90											
*Ricambio di qualità equivalente Parts of matching quality												

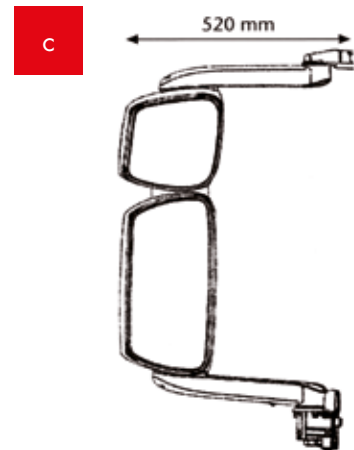
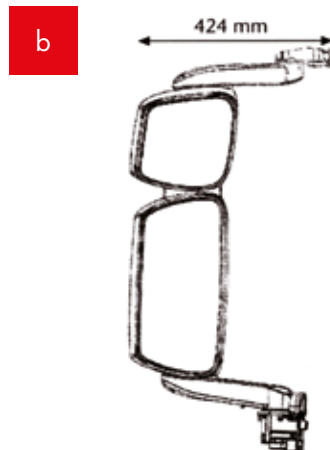
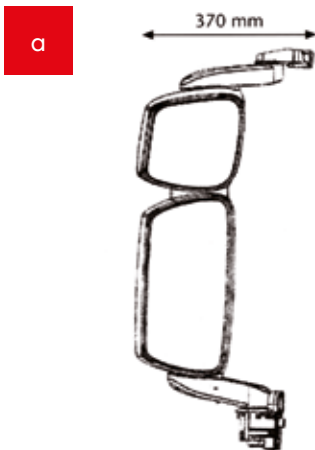

MERCEDES
ACTROS MP3

		ECE		300		1200			
		70.1008.01							
		70.1009.01							
	1	70.1009.50						mm 401x200	
	1	70.1008.50						mm 401x200	
	2	70.1009.60						mm 191x193	
	2	70.1008.60						mm 191x193	
*Ricambio di qualità equivalente <i>Parts of matching quality</i>									

MERCEDES
CITARO - CITY CLASS

		ECE		1200					
		70.1024.01							
		70.1025.01							
*Ricambio di qualità equivalente <i>Parts of matching quality</i>									

OPEL
MOVANO
03→10

		ECE		1200					
		70.1042.01							
		70.1043.01							
*Ricambio di qualità equivalente <i>Parts of matching quality</i>									

OPEL **MOVANO** **10→**

		ECE 1200	
	70.1044.01		
	70.1045.01		
*Ricambio di qualità equivalente Parts of matching quality			

SCANIA **SERIE 4 - 124/144** **07→**

		ECE 1200	
	70.1013.01		
	1 70.1013.20		
			mm 460x470x120
			mm 460x270
*Ricambio di qualità equivalente Parts of matching quality			

SCANIA **SERIE 4 - 124/144** **07→**

		ECE 300 1200	
	a 70.1014.01		
	b 70.1015.01		
	1 70.1014.50		
	2 70.1014.60		
	3 70.1014.20		
	3 70.1015.20		
	4 70.1014.30		
	4 70.1015.30		
*Ricambio di qualità equivalente Parts of matching quality			

VOLVO
FH - FM II
02→

		ECE		300		1200		
	a	70.1016.01						mm 610x420x100
	b	70.1017.01						mm 610x420x100
	1	70.1016.50						mm 200x435x15
	2	70.1016.60						mm 176x188x15
	3	70.1016.20						mm 610x420x100
	3	70.1017.20						mm 610x420x100
	4	70.1016.30						mm 220x250x70
	4	70.1016.30						mm 220x250x70
*Ricambio di qualità equivalente Parts of matching quality								

RIFERIMENTI ORIGINALI ORIGINAL PARTS NUMBERS

AVVERTENZE PER LA CONSULTAZIONE

i riferimenti originali riportati nelle tabelle seguenti, sono forniti a mero titolo informativo ed il loro utilizzo nel presente catalogo ha l'unico scopo di aiutare e agevolare la corretta identificazione del modello di veicolo sul quale deve montarsi il pezzo di ricambio.

Si avverte, ad ogni fine, che la scelta dei prodotti deve essere determinata ed avvenire unicamente in base ai codici Olsa Parts riportati nelle parti illustrative del catalogo (sez. Illuminazione da pag. 5 a pag. 28/sez. Specchi retrovisori da pag. 31 a pag. 39).

NOTES FOR CONSULTATION

the original references which are reported in the following tables are provided for information purposes only and their use in this catalogue must be intended only and just to help and facilitate the correct identification of the vehicle model on which the spare parts must be fitted to.

In any event, we warn that the choice of products must be determined only by and according to Olsa Parts references contained in the illustrated sections of this catalogue (sect. Lamps from page 5 to page 28 / sect. Mirrors from page 31 to page 39).

DAF	HL PARTS						
1328860	8.94.003.00	46522725	8.10.011.00	1474267080	8.94.172.00	98433939	8.94.158.00
1328861	8.94.002.00	46849354	8.10.012.00	1474268080	8.94.173.00	98433940	8.94.159.00
1641742	8.94.001.00	46849385	8.10.013.00	5801552552	70.1018.50	98433942	8.94.157.00
1641743	8.94.000.00	51717075	8.10.028.00	5801552553	70.1019.50	98437475	8.94.006.00
1725270	8.94.005.00	51717076	8.10.029.00	FORD	HL PARTS	98437476	8.94.007.00
1725273	8.94.004.00	51755051	8.94.101.00	1776500	70.1031.01	500340503	8.94.090.00
1835886	8.94.117.00	51755054	8.94.100.00	1805835	70.1030.01	500340543	8.94.091.00
1835887	8.94.116.00	51805934	8.94.098.00	BK3117682GL5JA6	70.1028.05	504020189	8.94.008.00
FIAT	HL PARTS	51805935	8.94.099.00	BK3117682RL5JA6	70.1026.05	504020193	8.94.009.00
5960486	8.10.016.00	51867675	8.10.030.00	BK3117683GL5JA6	70.1029.05	504032145	8.94.080.00
5960487	8.10.017.00	51867677	8.10.31.00	BK3117683RL5JA6	70.1027.05	504032148	8.94.082.00
7642681	8.10.014.00	71716699	70.1018.60	BK3117K7746AA	70.1027.20	504150526	70.1001.02
7642682	8.10.015.00	71716700	70.1019.60	ISUZU	HL PARTS	504150527	70.1000.02
7658225	8.10.025.00	71716701	70.1019.40	8973768972	8.94.075.00	504150538	70.1003.02
7658227	8.10.024.00	71716702	70.1018.40	8973768982	8.94.074.00	504150539	70.1002.02
46411400	8.10.026.00	735480886	70.1038.50	IVECO	HL PARTS	504150551	70.1005.02
46411401	8.10.027.00	735480887	70.1018.01	3801926	70.1021.60	504150552	70.1004.02
46421728	8.10.000.00	735480888	70.1036.01	3801927	70.1020.40	504158937	70.1001.80
46421729	8.10.001.00	735480889	70.1038.01	3801928	70.1021.40	504158943	70.1000.80
46421732	8.10.004.00	735480933	70.1039.50	3801929	70.1020.60	504158974	70.1001.20
46421733	8.10.005.00	735480934	70.1019.01	4765922	8.94.070.00	504158976	70.1001.30
46421734	8.10.002.00	735480935	70.1037.01	4766018	8.94.071.00	504158977	70.1000.30
46421735	8.10.003.00	735480936	70.1039.01	4861793	8.94.092.00	504168236	70.1032.50
46421736	8.10.006.00	735620707	70.1036.50	4861794	8.94.093.00	504181095	8.50.058.00
46421737	8.10.007.00	735620749	70.1037.50	41221015	8.94.136.00	504181096	8.50.060.00
46522719	8.10.008.00	1328430080	8.94.104.00	41221036	8.94.137.00	504224428	70.1034.50
46522720	8.10.009.00	1328431080	8.94.105.00	69500010	8.94.134.00	504238093	8.94.010.00
46522724	8.10.010.00	1374292080	8.94.180.00	69500013	8.94.135.00	504238117	8.94.011.00
		1374296080	8.94.181.00	98433741	8.94.156.00	504238203	8.94.138.00

504238213	8.94.139.00	2118200556	8.94.169.00	A9438201761	8.94.022.00	1732510	8.94.044.00
504369796	70.1000.90	2118200656	8.94.168.00	A9608200956	8.94.127.00	1760551	8.94.051.60
504369798	70.1001.90	9018200161	8.94.167.00	A9608201056	8.94.126.00	1760554	8.94.050.60
804158975	70.1000.20	9018200261	8.94.166.00	A9738200561	8.94.025.00	1931613	8.94.149.60
5801367569	70.1041.01	9018202461	8.94.107.00	A9738200661	8.94.024.00	1931614	8.94.148.60
5801367573	70.1040.01	9018202561	8.94.106.00	A9738202861	8.94.027.00	VOLVO	HL PARTS
5801367608	70.1021.01	9408200056	8.94.031.00	A9738202961	8.94.026.00	3981594	8.94.150.00
5801367608	70.1041.50	9408200156	8.94.030.00	OPEL	HL PARTS	6793924	8.94.176.00
5801367640	70.1020.01	9408200161	8.94.069.00	4408527	70.1042.01	20360273	8.94.171.00
5801367641	70.1040.50	9408200261	8.94.068.00	4408529	70.1043.01	20360274	8.94.170.00
5801375414	8.94.178.00	9418204361	8.94.165.00	4419408	70.1045.01	20360810	70.1017.20
5801375416	8.94.179.00	9418204461	8.94.164.00	4419409	70.1044.01	20360898	8.94.063.00
5801377880	8.94.188.00	9418205361	8.94.143.00	RENAULT	HL PARTS	20360899	8.94.062.00
5801377881	8.94.189.00	9418205461	8.94.142.00	5001840475	8.94.038.00	20455981	70.1016.01
5801405677	70.1020.19	9418205561	8.94.145.00	5001840476	8.94.039.00	20455982	70.1017.01
5801473749	8.94.186.00	9418205661	8.94.144.00	5010231669	8.94.163.00	20455986	70.1016.50
5801473750	8.94.187.00	9418206161	8.94.175.00	5010231670	8.94.162.00	20455995	70.1016.60
5801552552	70.1023.01	9418206261	8.94.174.00	5010231849	8.94.041.00	20589831	70.1016.30
5801552553	70.1022.01	9438105816	70.1009.01	5010231850	8.94.040.00	20710524	8.94.061.20
5801745449	8.94.119.00	9438106016	70.1008.01	5010578451	8.94.047.00	20710525	8.94.060.20
5801745452	8.94.118.00	9608200456	8.94.123.00	5010578454	8.94.043.00	20746401	70.1016.20
5802031841	70.1021.50	9608200556	8.94.122.00	5010578475	8.94.046.00	20818763	8.94.067.00
5802031932	70.1020.50	9738202861	8.94.029.00	5010578478	8.94.042.00	20818771	8.94.066.00
MAN	HL PARTS	9738202961	8.94.028.00	5010623619	8.94.124.00	20861573	8.94.061.60
81251016290	8.94.078.00	A00181409816	70.1025.01	5010623620	8.94.125.00	20861573	8.94.131.00
81251016291	8.94.079.00	A0028208656	8.94.147.00	SCANIA	HL PARTS	20861574	8.94.130.00
81251016338	8.94.140.00	A0028208756	8.94.146.00	1346378	70.1014.50	21035637	8.94.056.00
81251016339	8.94.141.00	A6708106093	70.1024.01	1366135	70.1015.30	21035637	8.94.086.00
81251016448	8.94.032.00	A9018202661	8.94.109.00	1366136	70.1014.30	21035638	8.94.057.00
81251016449	8.94.033.00	A9018202761	8.94.108.00	1366141	70.1013.20	21035638	8.94.087.00
81251016450	8.94.084.00	A9068200561	8.94.113.00	1396503	70.1015.20	21035690	8.94.058.00
81251016451	8.94.085.00	A9068200661	8.94.112.00	1396541	70.1014.20	21035692	8.94.059.00
81251016498	8.94.034.00	A9418205161	8.94.013.00	1422991	8.94.049.00	21221151	8.94.155.00
81251016499	8.94.035.00	A9418205261	8.94.012.00	1422992	8.94.048.00	21221152	8.94.154.00
81251016500	8.94.133.00	A9438200056	8.94.019.00	1443864	70.1014.60	21297917	8.94.064.00
81251016501	8.94.132.00	A9438200156	8.94.018.00	1446353	8.94.055.00	21297918	8.94.065.00
81251016521	8.94.073.00	A9438200161	8.94.015.00	1446354	8.94.054.00	82140744	8.94.153.00
81251016522	8.94.072.00	A9438200261	8.94.014.00	1446355	8.94.053.00	82140763	8.94.152.00
MERCEDES	HL PARTS	A9438200361	8.94.017.00	1446356	8.94.052.00		
0028113333	70.1009.50	A9438200461	8.94.016.00	1723518	70.1013.01		
0028113433	70.1008.50	A9438201461	8.94.021.00	1723518	70.1015.01		
0028113733	70.1009.60	A9438201561	8.94.020.00	1723519	70.1014.01		
0028113833	70.1008.60	A9438201661	8.94.023.00	1732509	8.94.045.00		

INDICE PER CODICE CODE INDEX

CODICE	PAG	CODICE	PAG	CODICE	PAG	CODICE	PAG	CODICE	PAG
70.1000.02	36	70.1023.01	35	8.10.016.00	7	8.94.029.00	18	8.94.084.00	14
70.1000.20	36	70.1023.50	35	8.10.017.00	7	8.94.030.00	17	8.94.085.00	14
70.1000.30	36	70.1024.01	37	8.10.022.00	28	8.94.031.00	17	8.94.086.00	26
70.1000.80	36	70.1025.01	37	8.10.024.00	5	8.94.032.00	14	8.94.087.00	26
70.1000.90	36	70.1026.05	32	8.10.025.00	5	8.94.033.00	14	8.94.088.00	22
70.1001.02	36	70.1026.20	32	8.10.026.00	5	8.94.034.00	15	8.94.090.00	11
70.1001.20	36	70.1026.30	32	8.10.027.00	5	8.94.035.00	15	8.94.091.00	11
70.1001.30	36	70.1026.50	32	8.10.028.00	6	8.94.038.00	20	8.94.092.00	11
70.1001.80	36	70.1027.05	32	8.10.029.00	6	8.94.039.00	20	8.94.093.00	11
70.1001.90	36	70.1027.20	32	8.10.030.00	6	8.94.040.00	21	8.94.098.00	5
70.1002.02	36	70.1027.30	32	8.10.031.00	6	8.94.041.00	21	8.94.099.00	5
70.1003.02	36	70.1027.50	32	8.50.058.00	12	8.94.042.00	21	8.94.100.00	5
70.1004.02	36	70.1028.05	33	8.50.060.00	12	8.94.043.00	21	8.94.101.00	5
70.1005.02	36	70.1029.05	33	8.90.050.60	13	8.94.044.00	23	8.94.104.00	9
70.1008.01	37	70.1030.01	32	8.90.053.60	13	8.94.045.00	23	8.94.105.00	9
70.1008.50	37	70.1030.20	32	8.90.054.60	19	8.94.046.00	22	8.94.106.00	19
70.1008.60	37	70.1030.30	32	8.90.055.60	19	8.94.047.00	22	8.94.107.00	19
70.1009.01	37	70.1030.50	32	8.90.056.60	22	8.94.048.00	22	8.94.108.00	20
70.1009.50	37	70.1031.01	32	8.90.057.60	22	8.94.049.00	22	8.94.109.00	20
70.1009.60	37	70.1031.20	32	8.90.058.60	23	8.94.050.00	24	8.94.110.00	20
70.1013.01	38	70.1031.30	32	8.90.059.60	23	8.94.050.60	24	8.94.111.00	20
70.1013.20	38	70.1031.50	32	8.90.060.60	24	8.94.051.00	24	8.94.112.00	20
70.1014.01	38	70.1032.50	35	8.90.061.60	24	8.94.051.60	24	8.94.113.00	20
70.1014.20	38	70.1034.50	35	8.90.066.60	25	8.94.052.00	23	8.94.116.00	9
70.1014.30	38	70.1036.01	31	8.90.067.60	25	8.94.053.00	23	8.94.117.00	9
70.1014.50	38	70.1036.50	31	8.90.068.60	27	8.94.054.00	24	8.94.118.00	13
70.1014.60	38	70.1037.01	31	8.90.069.60	27	8.94.055.00	24	8.94.119.00	13
70.1015.01	38	70.1037.50	31	8.94.000.00	9	8.94.056.00	25	8.94.122.00	19
70.1015.20	38	70.1038.01	31	8.94.001.00	9	8.94.057.00	25	8.94.123.00	19
70.1015.30	38	70.1038.50	31	8.94.002.00	9	8.94.058.00	26	8.94.124.00	23
70.1016.01	39	70.1039.01	31	8.94.003.00	9	8.94.059.00	26	8.94.125.00	23
70.1016.20	39	70.1039.50	31	8.94.004.00	9	8.94.060.20	27	8.94.126.00	19
70.1016.30	39	70.1040.01	34	8.94.005.00	9	8.94.060.60	26	8.94.127.00	19
70.1016.50	39	70.1040.50	34	8.94.006.00	12	8.94.060.66	26	8.94.128.00	13
70.1016.60	39	70.1041.01	34	8.94.007.00	12	8.94.060.68	26	8.94.129.00	13
70.1017.01	39	70.1041.50	34	8.94.008.00	12	8.94.061.20	27	8.94.130.00	27
70.1017.20	39	70.1042.01	37	8.94.009.00	12	8.94.061.60	26	8.94.131.00	27
70.1018.01	31	70.1043.01	37	8.94.010.00	13	8.94.062.00	27	8.94.132.00	15
70.1018.40	31	70.1044.01	38	8.94.011.00	13	8.94.062.19	27	8.94.133.00	15
70.1018.50	31	70.1045.01	38	8.94.012.00	16	8.94.063.00	27	8.94.134.00	10
70.1018.60	31	8.10.000.00	5	8.94.013.00	16	8.94.064.00	25	8.94.135.00	10
70.1019.01	31	8.10.001.00	5	8.94.014.00	16	8.94.065.00	25	8.94.138.00	13
70.1019.40	31	8.10.002.00	6	8.94.015.00	16	8.94.066.00	27	8.94.139.00	13
70.1019.50	31	8.10.003.00	6	8.94.016.00	17	8.94.067.00	27	8.94.140.00	14
70.1019.60	31	8.10.004.00	6	8.94.017.00	17	8.94.068.00	19	8.94.141.00	14
70.1020.01	34	8.10.005.00	6	8.94.018.00	17	8.94.069.00	19	8.94.142.00	15
70.1020.19	34	8.10.006.00	6	8.94.019.00	17	8.94.070.00	12	8.94.143.00	15
70.1020.40	34	8.10.007.00	6	8.94.020.00	17	8.94.071.00	12	8.94.144.00	15
70.1020.50	34	8.10.008.00	7	8.94.021.00	17	8.94.072.00	15	8.94.145.00	15
70.1020.60	34	8.10.009.00	7	8.94.022.00	18	8.94.073.00	15	8.94.146.00	16
70.1021.01	34	8.10.010.00	7	8.94.023.00	18	8.94.074.00	14	8.94.147.00	16
70.1021.40	34	8.10.011.00	7	8.94.024.00	18	8.94.075.00	14	8.94.148.60	23
70.1021.50	34	8.10.012.00	7	8.94.025.00	18	8.94.078.00	14	8.94.149.60	23
70.1021.60	34	8.10.013.00	7	8.94.026.00	18	8.94.079.00	14	8.94.150.00	25
70.1022.01	35	8.10.014.00	7	8.94.027.00	18	8.94.080.00	12	8.94.152.00	26
70.1022.50	35	8.10.015.00	7	8.94.028.00	18	8.94.082.00	12	8.94.153.00	26

CODICE	PAG
8.94.154.00	26
8.94.155.00	26
8.94.156.00	10
8.94.157.00	10
8.94.158.00	10
8.94.159.00	10
8.94.162.00	21
8.94.163.00	21

CODICE	PAG
8.94.164.00	16
8.94.165.00	16
8.94.166.00	20
8.94.167.00	20
8.94.168.00	21
8.94.169.00	21
8.94.170.00	24
8.94.171.00	24

CODICE	PAG
8.94.172.00	10
8.94.173.00	10
8.94.174.00	16
8.94.175.00	16
8.94.176.00	24
8.94.178.00	11
8.94.179.00	11
8.94.180.00	10

CODICE	PAG
8.94.181.00	10
8.94.184.00	18
8.94.185.00	18
8.94.186.00	11
8.94.187.00	11
8.94.188.00	11
8.94.189.00	11

CONDIZIONI GENERALI DI VENDITA

1. Le presenti Condizioni Generali di Vendita si applicano a tutti gli ordini accettati dalla Olsa Parts S.r.l.. Condizioni difformi da quelle qui contenute saranno valide solo se redatte in forma scritta.
2. Nessun ordine sarà considerato accettato fino a quanto lo stesso non sarà confermato mediante conferma emessa dal fornitore.
3. I rischi legati alla merce in viaggio sono a totale carico del committente pur nella condizione di vendita "PORTO FRANCO".
4. Eventuali reclami sulle quantità dovranno essere contestati allo spedizioniere all'atto del ricevimento della merce, presenti o meno l'imballo tracce d'effrazione.
5. Ogni reclamo sulla qualità della merce dovrà esserci comunicato entro e non oltre otto giorni dal ricevimento della merce, mediante fax o E-mail.
6. Verrà sostituito quel materiale che, reso franco nostro domicilio, venga da noi ritenuto difettoso. Il reso del materiale deve essere in ogni caso espressamente autorizzato ed il reclamo deve essere inviato entro 12 mesi dalla data della fattura di vendita. La garanzia è limitata al costo dei particolari difettosi, con esclusione di qualsiasi indennizzo per i danni subiti in conseguenza del reclamo.
7. Il pagamento deve avvenire nei termini e forme pattuite e per l'intero importo della fattura; non sono pertanto ammessi sconti o detrazioni a qualsivoglia titolo.
8. In caso di ritardato pagamento il fornitore avrà diritto, senza necessità di messa in mora, ad interessi moratori nella misura del tasso ufficiale di sconto maggiorato di cinque punti.
9. I nostri prodotti sono omologati secondo le norme vigenti in Europa.
10. Le immagini e i riferimenti originali in questo catalogo non sono vincolanti e devono essere considerati a puro titolo indicativo.
11. È vietata qualsiasi riproduzione, anche parziale, del presente catalogo, senza preventiva autorizzazione della Olsa Parts S.r.l.
12. Olsa Parts S.r.l. declina ogni responsabilità per eventuali errori od omissioni relativi a dati ed immagini in esso contenute e si riserva il diritto di apportare modifiche senza obbligo di preavviso.
13. Per qualsiasi controversia il Foro competente sarà quello di Torino.

GENERAL SALES CONDITIONS TERMS

1. These general sales conditions terms are valable for all the orders accepted from OLSA PARTS S.r.l. Different conditions are only valable in written form.
2. The orders will be considered as accepted only after the supplier's confirmation.
3. Delivery risks are totally at the customer's charge, even if the sales conditions are "free port".
4. Any complain against good's quantity must be notified to the forwarder at the moment of the goods reception, if the packaging seems to be forced or not.
5. Every complain against good's quality must be notified within eight days from good's reception, by Fax or E-mail.
6. Only those parts will be replaced, which are considered as fault from us. Those parts must be delivered to our warehouse f.o.c. The material may be returned only after expressed authorisation of the supplier and the complain must be sent within 12 months after sales invoice. The warranty only cover the cost of the fault part, excluding any further indemnity for damages caused by the complain.
7. The payment must be made under the agreed form and terms for the total amount of the invoice; deductions or discounts for any reason are not allowed.
8. For delayed payments the supplier has the right, without moratorium, to apply an interest on the base of the official discount rate increased of 5 points.
9. Our products are approved according to the European norms.
10. The pictures and the original references of the catalogue have to be considered just as an indication and are not binding.
11. It is forbidden any reproduction, even if partial, of this catalogue without authorisation of OLSA PARTS S.r.l.
12. OLSA PARTS S.r.l. is not responsible for errors and omissions relating data and pictures and reserve the right to modify without previous notice.
13. For any dispute the court will be in Torino (Italy).



by OLSA PARTS s.r.l.
corso Allamano, 70
10098 RIVOLI (TO) | Italia
tel. +39.011.64.74.394
fax +39.011.64.74.395
011.95.04.107
vendite@olsaparts.it
www.olsaparts.it

