

OLSA *Parts*

SUPPLEMENTO
SETTEMBRE 2019
SEPTEMBER ADDENDUM





SUPPLEMENTO SETTEMBRE 2019
SEPTEMBER ADDENDUM 2019

INDICE *Index*

SUPPLEMENTO ADDENDUM	4
RIFERIMENTI ORIGINALI ORIGINAL PART NUMBERS	28
INDICE PER CODICE CODE INDEX	31

DESCRIZIONE DEI SIMBOLI

Symbols description

-  Destra | *Right*
-  Sinistra | *Left*
-  Manuale | *Manual*
-  Predisposto elettrico | *Fitted for electric*
-  Elettrico | *Electric*
-  Fendinebbia | *Fog lamp*

IL PRESENTE CATALOGO SI PREFIGGE LA CORRETTA CLASSIFICAZIONE DELLA PARTE DI RICAMBIO NECESSARIA ALLA RIPARAZIONE DELLA VETTURA ED INDIVIDUA I PRODOTTI/ARTICOLI COMMERCIALIZZATI E DISTRIBUITI DA OLSA PARTS.

I prodotti commercializzati da OLSA Parts rientrano in tre differenti tipologie di prodotto:

- 1) Ricambio originale
- 2) Ricambio di qualità equivalente
- 3) Articoli universali

N.B.: AI FINI DEL PRESENTE CATALOGO, PER RICAMBI ORIGINALI, RICAMBI DI QUALITÀ EQUIVALENTE E ARTICOLI UNIVERSALI DEVONO INTENDERSI PRODOTTI/ARTICOLI RISPONDENTI ALLE DEFINIZIONI DI SEGUITO DATE IN CONFORMITÀ ALL'ATTUALE NORMATIVA VIGENTE IN MATERIA.

AD ECCEZIONE DEI RICAMBI ORIGINALI, LA TIPOLOGIA "RICAMBIO DI QUALITÀ EQUIVALENTE" E "ARTICOLO UNIVERSALE" - PER LA LORO ESATTA INDIVIDUAZIONE - VIENE ESPRESSAMENTE RIPORTATA IN CALCE ALLA RAPPRESENTAZIONE DEL PRODOTTO APPARTENENTE ALLE DUE SUDDETTE CATEGORIE.

SE NON DIVERSAMENTE SPECIFICATO IN CALCE ALL'ARTICOLO, COME AVVIENE PER I RICAMBI DI QUALITÀ EQUIVALENTE E ARTICOLI UNIVERSALI, IL PRODOTTO DEVE INTENDERSI "RICAMBIO ORIGINALE".

In particolare:

1) **RICAMBIO ORIGINALE:** *I ricambi originali mostrati dal presente catalogo e distribuiti da OLSA Parts, sono tutti gli articoli prodotti da OLSA Industriale, nonché ulteriori articoli prodotti da aziende diverse da OLSA Industriale.*

OLSA Industriale e le Aziende diverse dalla stessa i cui prodotti, presenti nel presente catalogo, vengono distribuiti da OLSA Parts, sono costruttori di ricambi originali conformemente alle previsioni di legge vigenti.

Si ricorda che in base alla definizione contenuta nel paragrafo 19, Titolo III, delle Linee Guida al Regolamento UE n. 461/2010, sostitutivo del Regolamento n. 1400/2002 (Legge Monti) per ricambi originali si intendono "LE PARTI O APPARECCHIATURE COSTRUITE CONFORMEMENTE ALLE SPECIFICHE E ALLE NORME DI PRODUZIONE FORNITE DAL COSTRUTTORE DEL VEICOLO. (...) SALVO PROVA CONTRARIA, SI PRESUME CHE LE PARTI COSTITUISCONO PARTI ORIGINALI SE IL COSTRUTTORE DELLE STESSE CERTIFICA CHE ESSE HANNO QUALITÀ EQUIVALENTI AI COMPONENTI UTILIZZATI PER L'ASSEMBLAGGIO DEL VEICOLO IN QUESTIONE E SONO STATE COSTRUITE CONFORMEMENTE ALLE SPECIFICHE ED ALLE NORME DI PRODUZIONE DEL VEICOLO".

2) I **RICAMBI DI QUALITÀ EQUIVALENTE** *sono espressamente indicati in calce ad ogni singolo articolo appartenente a questa tipologia* e per essi, in base alla definizione contenuta nel paragrafo 20, Titolo III, delle Linee Guida al Regolamento UE n. 461/2010, sostitutivo del Regolamento n. 1400/2002 (Legge Monti), si intendono "I PEZZI DI RICAMBIO DOTATI DI QUALITÀ SUFFICIENTEMENTE ELEVATA, IN MODO CHE IL LORO USO NON COMPROMETTA LA REPUTAZIONE DELLA RETE AUTORIZZATA IN QUESTIONE".

3) Per **ARTICOLI UNIVERSALI**, *espressamente indicati in calce ad ogni singolo articolo (a titolo esemplificativo fari lavoro, catadiottri, plafoniere, luci ingombro, pannelli riflettenti, lampade rotanti, ecc...), si intendono tutti i prodotti distribuiti e commercializzati da OLSA Parts "non appartenenti e rientranti nella categoria di ricambio originale e/o di ricambio di qualità equivalente".*

Alcuni prodotti facenti parte di tale tipologia sono soggetti ad omologazione ministeriale e/o europea necessaria all'attestazione delle loro prestazioni. **Per tali specifici articoli OLSA Parts distribuisce solo ed esclusivamente prodotti recanti le suddette omologazioni e fornisce ai clienti che ne facciano richiesta la documentazione relativa.**

LE MARCHE CITATE NEL PRESENTE CATALOGO, SONO DI PROPRIETÀ DEI COSTRUTTORI AUTO CUI SI RIFERISCONO.

IL LORO UTILIZZO NEL PRESENTE CATALOGO, COSÌ COME I RIFERIMENTI ORIGINALI INCLUSI (CROSS REFERENCES), HANNO L'UNICO SCOPO DI AIUTARE E AGEVOLARE L'IDENTIFICAZIONE DEL MODELLO D'AUTO SUL QUALE DEVE MONTARSI IL PEZZO DI RICAMBIO. PER IL CORRETTO UTILIZZO DELLE CROSS REFERENCES SI VEDANO LE "AVVERTENZE PER LA CONSULTAZIONE" AL FONDO DEL PRESENTE CATALOGO.

N.B.: NEL PRESENTE CATALOGO È INOLTRE PRESENTE UNA SEZIONE NELLA QUALE SONO RIPORTATI ARTICOLI DEFINITI "ACCESSORI". ESSI NON HANNO QUINDI LA FINALITÀ DI RISTABILIRE L'ASPETTO ORIGINARIO DEL VEICOLO MA SOLO LA FUNZIONE DI MIGLIORARE ESTETICAMENTE O MODIFICARE L'ASPETTO DEL PRODOTTO. PERTANTO TALI COMPONENTI NON DEVONO ESSERE CONSIDERATI RICAMBI BENSÌ ACCESSORI.

THIS CATALOGUE AIMS AT PROPERLY IDENTIFYING AND VERIFYING THE NECESSARY SPARE PARTS TO REPAIR THE CAR AND IDENTIFIES THE PRODUCTS/ITEMS DISTRIBUTED BY OLSA PARTS.

The products distributed by OLSA PARTS can be categorized into three different product types:

- 1) Original Equipment parts
- 2) Matching Quality spare parts
- 3) Universal parts

N.B. HEREBY DESCRIBED ARE THE DEFINITIONS OF ORIGINAL EQUIPMENT PARTS, MATCHING QUALITY SPARE PARTS AND UNIVERSAL PARTS IN ACCORDANCE WITH THE CURRENT LEGISLATION IN FORCE.

WITH THE EXCEPTION OF ORIGINAL EQUIPMENT PARTS, THE TYPE OF "MATCHING QUALITY SPARE PARTS" AND THE TYPE OF "UNIVERSAL PARTS" ARE EXPRESSLY STATED AT THE BOTTOM OF THE REPRESENTATION OF THE PRODUCT BELONGING TO THE ABOVE CATEGORIES.

IF NOT OTHERWISE INDICATED AT THE BOTTOM OF THE PRODUCT, AS IT IS FOR THE OTHER TWO TYPES, THE PARTS ARE TO BE CONSIDERED AS ORIGINAL EQUIPMENT.

In particular:

1) **ORIGINAL EQUIPMENT PARTS:** *This catalogue shows original equipment parts as distributed by OLSA PARTS which are all manufactured by OLSA Spa as well as other products, manufactured by companies other than OLSA S.p.a.* OLSA S.p.a. and the companies other than OLSA S.p.a. itself, whose products are shown in this catalogue and are distributed by OLSA PARTS, are manufacturers of original equipment parts in accordance with the law in force. Please note that according to the definition contained in paragraph 19, Title III of the Guidelines to the EU Regulation n. 461/2010, replacing Regulation n. 140/2002 (Monti Law), original equipment part means "PARTS OR EQUIPMENT WHICH ARE MANUFACTURED ACCORDING TO THE SPECIFICATIONS AND PRODUCTION STANDARD PROVIDED BY THE MOTOR VEHICLE MANUFACTURER [...] IT IS PRESUMED UNLESS THE CONTRARY IS PROVEN, THAT PARTS CONSTITUTE ORIGINAL PARTS IF THE PART MANUFACTURER CERTIFIES THAT THE PARTS MATCH THE QUALITY OF THE COMPONENTS USED FOR THE ASSEMBLY OF THE MOTOR VEHICLE IN QUESTION..."

2) **MATCHING QUALITY PARTS** *are specified at the bottom of every single item belonging to category and for them,* according to paragraph 20, Title III of the Guidelines to the EU Regulation n. 461/2010, replacing Regulation n. 140/2002 (Monti Law), it is to be assumed "PARTS WITH A SUFFICIENTLY HIGH QUALITY THAT THEIR USE DOES NOT ENDANGER THE REPUTATION OF THE AUTHORIZED NETWORK IN QUESTION..."

3) As **UNIVERSAL PARTS**, *specifically indicated at the bottom of every single product (such as work lights, reflectors, dome lamps, side markers, revolving beacons etc) it is to be intended all items distributed by OLSA PARTS "not belonging to the category of original equipment part and/or to the category of matching quality part".* Some of these products are subject to ministerial or European approval to certify their performance. **For these specific items, OLSA PARTS distributes only certified and approved parts and, on customer's request, can provide the related documents.**

BRANDS MENTIONED IN THIS CATALOGUE ARE PROPERTY OF THE CAR MAKER WHICH THEY REFER TO. THEIR USE IN THIS CATALOGUE, AS WELL AS THE OE REFERENCES INCLUDED, ARE ONLY MEANT TO HELP AND FACILITATE THE IDENTIFICATION OF THE CAR MODEL WHICH THE SPARE PARTS MUST BE FITTED TO. FOR A CORRECT USE OF THE CROSS REFERENCES, PLEASE REFER TO THE SECTION "NOTES FOR CONSULTATION" AT THE END OF THIS CATALOGUE.

N.B. IN THIS CATALOGUE THERE IS A SECTION WHICH SHOWS ITEMS WHICH ARE DEFINED "ACCESSORIES". THEY ARE NOT INTENDED TO RESTORE THE ORIGINAL APPEARANCE OF THE VEHICLE, BUT THEY ONLY HAVE THE FUNCTION TO CHANGE OR TO IMPROVE THE APPEARANCE OF THE ITEM ITSELF. CONSEQUENTLY, THESE COMPONENTS SHOULD NOT BE CONSIDERED AS SPARE PARTS BUT JUST ACCESSORIES.

AUDI		A7 SPORTBACK		LED
	10→	FANALE LATERALE LED FLASHER LED	➔	5.02.104.80
		FANALE LATERALE LED FLASHER LED	➜	5.02.105.80

AUDI		Q2		LED
	16→	FANALE LATERALE LED FLASHER LED	➔	5.02.106.80
		FANALE LATERALE LED FLASHER LED	➜	5.02.107.80

BMW		SERIE 1		LED
	15→	FANALE POSTERIORE CON POSIZIONE A LED LED REAR LAMP	➔	1.04.254.00
		FANALE POSTERIORE CON POSIZIONE A LED LED REAR LAMP	➜	1.04.255.00
		ESTERNO EXTERNAL		

BMW		SERIE 1		LED
	15→	FANALE POSTERIORE CON POSIZIONE A LED LED REAR LAMP	➔	1.04.256.00
		FANALE POSTERIORE CON POSIZIONE E RETRONEBBIA A LED LED FOG LAMP REAR LAMP	➜	1.04.257.00
		INTERNO INTERNAL		

BMW		SERIE 2 ACTIVE TOURER		LED
	14→	FANALE POSTERIORE CON POSIZIONE A LED LED REAR LAMP	➔	1.04.246.00
		FANALE POSTERIORE CON POSIZIONE A LED LED REAR LAMP	➜	1.04.247.00
		ESTERNO EXTERNAL		

BMW		SERIE 2 ACTIVE TOURER	
	14→	FANALE POSTERIORE REAR LAMP	➔ 1.04.248.00
		FANALE POSTERIORE REAR LAMP	➑ 1.04.249.00
	ESTERNO EXTERNAL		

BMW		SERIE 2 ACTIVE TOURER		LED
	14→	FANALE POSTERIORE CON POSIZIONE A LED LED REAR LAMP	➔ 1.04.250.00	
		FANALE POSTERIORE CON POSIZIONE A LED LED REAR LAMP	➑ 1.04.251.00	
	INTERNO INTERNAL			

BMW		SERIE 2 ACTIVE TOURER	
	14→	FANALE POSTERIORE REAR LAMP	➔ 1.04.252.00
		FANALE POSTERIORE REAR LAMP	➑ 1.04.253.00
	INTERNO INTERNAL		

BMW		X1	
	15→	FANALE POSTERIORE REAR LAMP	➔ 1.04.238.00
		FANALE POSTERIORE REAR LAMP	➑ 1.04.239.00
	INTERNO INTERNAL		

BMW		X1		LED
	15→	FANALE POSTERIORE CON POSIZIONE LED LED REAR LAMP	➔ 1.04.240.00	
		FANALE POSTERIORE CON POSIZIONE LED LED REAR LAMP	➑ 1.04.241.00	
	INTERNO INTERNAL			

BMW		X1	
	15→	FANALE POSTERIORE REAR LAMP	➔ 1.04.242.00
		FANALE POSTERIORE REAR LAMP	➔ 1.04.243.00
	ESTERNO EXTERNAL		

BMW		X1		LED
	15→	FANALE POSTERIORE CON POSIZIONE LED LED REAR LAMP	➔ 1.04.244.00	
		FANALE POSTERIORE CON POSIZIONE LED LED REAR LAMP	➔ 1.04.245.00	
	ESTERNO EXTERNAL			

BMW		X5	
	06→13	FANALE LATERALE SIDE LAMP	➔ 1.02.182.00
		FANALE LATERALE SIDE LAMP	➔ 1.02.183.00

DAF		CF-LF-XF	
	01→	PROIETTORE PRED. ELETTRICO HEADL. WITH ELEC. PRED.	➔ 8.94.202.00
		PROIETTORE PRED. ELETTRICO HEADL. WITH ELEC. PRED.	➔ 8.94.203.00
	H7 - H1 - P21W - W5W * Ricambio di qualità equivalente Parts of matching quality		

DAF		XF 106		LED
	13→	PROIETTORE MANUALE CON DRL LED MAN. HEADL. LED DRL	➔ 8.94.200.00	
		PROIETTORE MANUALE CON DRL LED MAN. HEADL. LED DRL	➔ 8.94.201.00	
	H7 - H1 - P21W * Ricambio di qualità equivalente Parts of matching quality			

FIAT		DUCATO	
	06→11	PROIETTORE SENZA FENDINEBBIA HEADL. WITHOUT FOG LAMP	➔ 8.94.220.00
		PROIETTORE SENZA FENDINEBBIA HEADL. WITHOUT FOG LAMP	➜ 8.94.221.00
	H7 - H1 - PY21W - W5W 7 PIN 7 PINS * Ricambio di qualità equivalente Parts of matching quality		

FIAT		DUCATO	
	12→	PROIETTORE HEADL.	➔ 8.94.222.00
		PROIETTORE HEADL.	➜ 8.94.223.00
	H7 - PY21W - H15 - W5W 8 PIN 8 PINS * Ricambio di qualità equivalente Parts of matching quality		

FIAT		EGEA-TIPO BERLINA	
	15→	GRUPPO OTTICO POSTERIORE REAR OPTICAL UNIT	➔ 2.04.114.10
		GRUPPO OTTICO POSTERIORE REAR OPTICAL UNIT	➜ 2.04.115.10
	* Ricambio di qualità equivalente Parts of matching quality		

FIAT		FIORINO NEMO QUBO BIPPER	
	07→	PROIETTORE FENDINEBBIA FOG LAMP	➔ 8.20.066.00
		PROIETTORE FENDINEBBIA FOG LAMP	➜ 8.20.067.00
	H1		

FIAT		TALENTO-TRAFIC-NV300-VIVARO	
	15→	GRUPPO OTTICO POSTERIORE REAR OPTICAL UNIT	➔ 2.44.294.10
		GRUPPO OTTICO POSTERIORE REAR OPTICAL UNIT	➜ 2.44.295.10
	* Ricambio di qualità equivalente Parts of matching quality		

FORD		CONNECT	
	13→	FANALE POSTERIORE PARTE SUPERIORE REAR LAMP SUPER.	→ 2.44.316.00
		FANALE POSTERIORE PARTE SUPERIORE REAR LAMP SUPER.	← 2.44.317.00
		GRUPPO OTTICO POSTERIORE INFERIORE REAR OPTICAL UNIT INFER.	→ 2.44.314.10
		GRUPPO OTTICO POSTERIORE INFERIORE REAR OPTICAL UNIT INFER.	← 2.44.315.10
	* Ricambio di qualità equivalente <i>Parts of matching quality</i>		

FORD		CONNECT	
	01→	PROIETTORE CON MOTORINO HEADL. WITH ELEC. DEV.	→ 8.94.224.00
		PROIETTORE CON MOTORINO HEADL. WITH ELEC. DEV.	← 8.94.225.00
	H4 - PY21W - W5W * Ricambio di qualità equivalente <i>Parts of matching quality</i>		

FORD		CONNECT CUSTOM	
	17→	GRUPPO OTTICO POSTERIORE REAR OPTICAL UNIT	→ 2.44.312.10
		GRUPPO OTTICO POSTERIORE REAR OPTICAL UNIT	← 2.44.313.10
	* Ricambio di qualità equivalente <i>Parts of matching quality</i>		

FORD		TRANSIT COURIER	
	14→	PROIETTORE CON MOTORINO E CORNICE CROMATA HEADL. WITH ELEC. DEV. CHROMED FRAME	→ 8.94.226.00
		PROIETTORE CON MOTORINO E CORNICE CROMATA HEADL. WITH ELEC. DEV. CHROMED FRAME	← 8.94.227.00
	H15 - H7 - PY21W * Ricambio di qualità equivalente <i>Parts of matching quality</i>		

FORD		TRANSIT COURIER	
	14→	PROIETTORE CON MOTORINO E CORNICE NERA HEADL. WITH ELEC. DEV. BLACK FRAME	➔ 8.94.228.00
		PROIETTORE CON MOTORINO E CORNICE NERA HEADL. WITH ELEC. DEV. BLACK FRAME	➜ 8.94.229.00
	H15 - H7 - PY21W * Ricambio di qualità equivalente Parts of matching quality		

FORD		TRANSIT V 347	
	06→14	PROIETTORE CON MOTORINO HEADL. WITH ELEC. DEV.	➔ 8.94.230.00
		PROIETTORE CON MOTORINO HEADL. WITH ELEC. DEV.	➜ 8.94.231.00
	H4 - W5W - PY21W * Ricambio di qualità equivalente Parts of matching quality		

FORD		TRANSIT V 363	
	14→	PROIETTORE CON MOTORINO E CORNICE CROMATA HEADL. WITH ELEC. DEV. CHROMED FRAME	➔ 8.94.232.00
		PROIETTORE CON MOTORINO E CORNICE CROMATA HEADL. WITH ELEC. DEV. CHROMED FRAME	➜ 8.94.233.00
	H7 - H15 - W5W - PY21W * Ricambio di qualità equivalente Parts of matching quality		

FORD		TRANSIT V 363	
	14→	PROIETTORE CON MOTORINO E CORNICE NERA HEADL. WITH ELEC. DEV. BLACK FRAME	➔ 8.94.234.00
		PROIETTORE CON MOTORINO E CORNICE NERA HEADL. WITH ELEC. DEV. BLACK FRAME	➜ 8.94.235.00
	H7 - H15 - W5W - PY21W * Ricambio di qualità equivalente Parts of matching quality		

IVECO		STRALIS	
	04→07	PROIETTORE STRALIS CON MOTORINO HEADL. WITH ELEC. DEV.	➔ 8.94.136.00
		PROIETTORE STRALIS CON MOTORINO HEADL. WITH ELEC. DEV.	➜ 8.94.137.00
	H7 * Ricambio di qualità equivalente Parts of matching quality		

MERCEDES		ACTROS	
	13→	FANALE LATERALE SIDE LAMP	➔ 2.42.094.00
		FANALE LATERALE SIDE LAMP	➔ 2.42.095.00
	* Ricambio di qualità equivalente <i>Parts of matching quality</i>		

MERCEDES		AROCS-ANTOS	
	15→	PROIETTORE MANUALE MAN. HEADL.	➔ 8.94.216.00
		PROIETTORE MANUALE MAN. HEADL.	➔ 8.94.217.00
	H7 - H1 - PY21W - H21 - W5W * Ricambio di qualità equivalente <i>Parts of matching quality</i>		

MERCEDES		ATEGO		LED
	13→	FANALE ANTERIORE DRL LED - CON DIREZIONE FRONT LAMP LED DRL WITH INDICATOR	➔	2.41.132.80
		FANALE ANTERIORE DRL LED - CON DIREZIONE FRONT LAMP LED DRL WITH INDICATOR	➔	2.41.133.80
	PY21W * Ricambio di qualità equivalente <i>Parts of matching quality</i>			

MERCEDES		ATEGO		LED
	13→	FANALE ANTERIORE CON LUCE DIURNA CON DIREZIONE FRONT LAMP LED DRL WITH INDICATOR	➔	2.41.132.00
		FANALE ANTERIORE CON LUCE DIURNA CON DIREZIONE FRONT LAMP LED DRL WITH INDICATOR	➔	2.41.133.00
	PY21W - P21W * Ricambio di qualità equivalente <i>Parts of matching quality</i>			

MERCEDES		CLASSE C		LED
	07→14	FANALE LATERALE LED FLASHER LED	➔	5.02.110.80
		FANALE LATERALE LED FLASHER LED	➔	5.02.111.80

MERCEDES		CLASSE C		LED	
	13→	FANALE LATERALE FONDO NERO LED <i>FLASHER LED WITH BLACK MATT FINISH</i>	➔	5.02.112.80	
		FANALE LATERALE FONDO NERO LED <i>FLASHER LED WITH BLACK MATT FINISH</i>	➜	5.02.113.80	

MERCEDES		CLASSE C, S		LED	
	13→	FANALE LATERALE CROMATO LED <i>CHROME FLASHER LED</i>	➔	5.02.114.80	
		FANALE LATERALE CROMATO LED <i>CHROME FLASHER LED</i>	➜	5.02.115.80	

MERCEDES		CLASSE E			
	02→06	FANALE LATERALE LUCE DI CORTESIA <i>FLASHER WITH COVER FOR COURTESY LIGHT</i>	➔	5.02.116.00	
		FANALE LATERALE LUCE DI CORTESIA <i>FLASHER WITH COVER FOR COURTESY LIGHT</i>	➜	5.02.117.00	

MERCEDES		CLASSE E			
	06→09	FANALE LATERALE <i>FLASHER</i>	➔	5.02.118.00	
		FANALE LATERALE <i>FLASHER</i>	➜	5.02.119.00	

MERCEDES		EVOBUS-TRAVEGO-TOURISMO			
		FANALE POSTERIORE <i>REAR LAMP</i>	➔	2.44.296.00	
		FANALE POSTERIORE <i>REAR LAMP</i>	➜	2.44.297.00	
* Ricambio di qualità equivalente Parts of matching quality					

MERCEDES		MP4	
	12→	PROIETTORE MANUALE CON DRL MAN. HEADL. DRL	→ 8.94.208.00
		PROIETTORE MANUALE CON DRL MAN. HEADL. DRL	← 8.94.209.00
		H1 - H7 - P21W - H21 - W5W * Ricambio di qualità equivalente <i>Parts of matching quality</i>	



MERCEDES		MP4		XENON
	12→	PROIETTORE MANUALE XENON COMPLETO DI D1S E CENTRALINA CON DRL HEADLAMP XENON AND CONTROL UNIT LED DRL	→ 8.94.210.60	
		PROIETTORE MANUALE XENON COMPLETO DI D1S E CENTRALINA CON DRL HEADLAMP XENON AND CONTROL UNIT LED DRL	← 8.94.211.60	
		H1 - H21 - PY21 - W5W - D1S * Ricambio di qualità equivalente <i>Parts of matching quality</i>		





MERCEDES		VITO	
	03→13	GRUPPO OTTICO POSTERIORE REAR OPTIC. UNIT	→ 2.44.300.10
		GRUPPO OTTICO POSTERIORE REAR OPTIC. UNIT	← 2.44.301.10
		* Ricambio di qualità equivalente <i>Parts of matching quality</i>	

MERCEDES		VITO- VIVIANO	
	10→15	PROIETTORE CON MOTORINO E FENDINEBBIA HEADL. WITH ELEC. DEVICE	→ 8.94.236.00
		PROIETTORE CON MOTORINO E FENDINEBBIA HEADL. WITH ELEC. DEVICE	← 8.94.237.00
		3H7 - PY21W - W5W * Ricambio di qualità equivalente <i>Parts of matching quality</i>	



MINI		CLUBMAN	
	13→18	FANALE POSTERIORE CON POSIZIONE A LED REAR LAMP	→ 1.04.264.00
		FANALE POSTERIORE CON POSIZIONE A LED REAR LAMP	← 1.04.265.00

MINI		CLUBMAN	
	13→18	FANALE POSTERIORE REAR LAMP	➔ 1.04.266.00
		FANALE POSTERIORE REAR LAMP	➜ 1.04.267.00

MINI		CLUBMAN	
	13→18	FANALE POSTERIORE RETRONEBBIA REAR FOG LAMP	➔ 1.04.268.00
		FANALE POSTERIORE RETRONEBBIA REAR FOG LAMP	➜ 1.04.269.00

MINI		COOPER/ONE	
	13→18	FANALE POSTERIORE CON POSIZIONE A LED LED REAR LAMP	➔ 1.04.258.00
		FANALE POSTERIORE CON POSIZIONE A LED LED REAR LAMP	➜ 1.04.259.00

MINI		COOPER/ONE	
	13→18	FANALE POSTERIORE REAR LAMP	➔ 1.04.260.00
		FANALE POSTERIORE REAR LAMP	➜ 1.04.261.00

MINI		COOPER/ONE	
	13→18	FANALE LATERALE SIDE LAMP	➔ 1.02.180.00
		FANALE LATERALE SIDE LAMP	➜ 1.02.181.00

MINI		COOPER/ONE		
	13→18	FANALE RETRONEBBIA <i>FOG LAMP</i>	➔	1.04.262.00
		FANALE RETRONEBBIA <i>FOG LAMP</i>	➜	1.04.263.00

MINI		COOPER/ONE		
	06→13	FANALE LATERALE ANTERIORE <i>SIDE LAMP</i>	➔	1.02.174.00
		FANALE LATERALE ANTERIORE <i>SIDE LAMP</i>	➜	1.02.175.00

MINI		COOPER/ONE		LED
	13→18	FANALE LATERALE ANTERIORE LED LED SIDE LAMP	➔	1.02.174.80
		FANALE LATERALE ANTERIORE LED LED SIDE LAMP	➜	1.02.175.80

MINI		COOPER/ONE		
	06→13	FANALE LATERALE POSTERIORE <i>SIDE LAMP</i>	➔	1.02.176.00
		FANALE LATERALE POSTERIORE <i>SIDE LAMP</i>	➜	1.02.177.00

MINI		COOPER/ONE		LED
	13→18	FANALE LATERALE POSTERIORE LED LED SIDE LAMP	➔	1.02.176.80
		FANALE LATERALE POSTERIORE LED LED SIDE LAMP	➜	1.02.177.80





MINI	COUNTRYMAN	LED
	16→18 FANALE POSTERIORE CON POSIZIONE A LED CON RETROMARCIA LED REAR REVERSE LAMP	→ 1.04.270.00
	16→18 FANALE POSTERIORE CON POSIZIONE A LED CON RETRONEBBIA LED REAR FOG LAMP	← 1.04.271.00

MINI	COUNTRYMAN	
	16→18 FANALE POSTERIORE CON RETROMARCIA REAR REVERSE LAMP	→ 1.04.272.00
	16→18 FANALE POSTERIORE CON RETRONEBBIA REAR FOG LAMP	← 1.04.273.00

MINI	COUNTRYMAN	UK
	16→18 FANALE POSTERIORE CON POSIZIONE A LED CON RETRONEBBIA LED REAR FOG LAMP	→ 1.04.270.06
	16→18 FANALE POSTERIORE CON POSIZIONE A LED CON RETROMARCIA LED REAR REVERSE LAMP	← 1.04.271.06

MINI	COUNTRYMAN	UK
	16→18 FANALE POSTERIORE UK CON RETRONEBBIA REAR FOG LAMP	→ 1.04.272.06
	16→18 FANALE POSTERIORE UK CON RETROMARCIA REAR REVERSE LAMP	← 1.04.273.06

MINI	F56 LCI	UNION JACK
	13→18 FANALE POSTERIORE LCI REAR LAMP	→ 1.04.232.00
	13→18 FANALE POSTERIORE LCI REAR LAMP	← 1.04.233.00

MINI		F56 LCI	USA	
	13→18	FANALE POSTERIORE LCI USA REAR LAMP	➔	1.04.232.16
		FANALE POSTERIORE LCI USA REAR LAMP	➜	1.04.233.16
NISSAN		JUKE	LED	
	10→	FANALE LATERALE LED FLASHER LED	➔	5.02.120.80
		FANALE LATERALE LED FLASHER LED	➜	5.02.121.80
NISSAN - OPEL - RENAULT		PRIMASTAR - VIVARO - TRAFIC		
	02→14	FANALE POSTERIORE REAR LAMP	➔	5.44.130.00
		FANALE POSTERIORE REAR LAMP	➜	5.44.131.00
		PER VEICOLI CON 2 PORTE A BATTENTI - For vehicles with 2 swing doors Senza porta scorrevole - Without sliding doors FURGONE 2X260° VAN 2X260°		
NISSAN - OPEL - RENAULT		PRIMASTAR - VIVARO - TRAFIC		
	02→14	FANALE POSTERIORE REAR LAMP	➔	5.44.132.00
		FANALE POSTERIORE REAR LAMP	➜	5.44.133.00
		PER VEICOLI CON 2 PORTE A BATTENTI - For vehicles with 2 swing doors Con due porte scorrevoli - For 2 sliding doors FURGONE 2X260° VAN 2X260°		
NISSAN - OPEL - RENAULT		PRIMASTAR - VIVARO - TRAFIC		
	02→14	FANALE POSTERIORE REAR LAMP	➔	5.44.130.00
		FANALE POSTERIORE REAR LAMP	➜	5.44.133.00
		PER VEICOLI CON 2 PORTE A BATTENTI - For vehicles with 2 swing doors Porta scorrevole a sx - For left sliding door FURGONE 2X260° VAN 2X260°		

NISSAN - OPEL - RENAULT		PRIMASTAR - VIVARO - TRAFIC		
	02→14	FANALE POSTERIORE REAR LAMP	➔	5.44.132.00
		FANALE POSTERIORE REAR LAMP	➜	5.44.131.00
	PER VEICOLI CON 2 PORTE A BATTENTI - For vehicles with 2 swing doors Porta scorrevole a dx - For right sliding door FURGONE 2X260° VAN 2X260°			

NISSAN - OPEL - RENAULT		PRIMASTAR - VIVARO - TRAFIC		
	02→14	FANALE POSTERIORE REAR LAMP	➔	5.44.134.00
		FANALE POSTERIORE REAR LAMP	➜	5.44.135.00
	PER VEICOLI CON 2 PORTE A BATTENTI - For vehicles with 2 swing doors Senza porta scorrevole - Without sliding doors FURGONE 2X180° VAN 2X180°			

NISSAN - OPEL - RENAULT		PRIMASTAR - VIVARO - TRAFIC		
	02→14	FANALE POSTERIORE REAR LAMP	➔	5.44.136.00
		FANALE POSTERIORE REAR LAMP	➜	5.44.137.00
	PER VEICOLI CON 2 PORTE A BATTENTI - For vehicles with 2 swing doors Con due porte scorrevoli - For 2 sliding doors FURGONE 2X180° VAN 2X180°			

NISSAN - OPEL - RENAULT		PRIMASTAR - VIVARO - TRAFIC		
	02→14	FANALE POSTERIORE REAR LAMP	➔	5.44.134.00
		FANALE POSTERIORE REAR LAMP	➜	5.44.137.00
	PER VEICOLI CON 2 PORTE A BATTENTI - For vehicles with 2 swing doors Porta scorrevole a sx - For left sliding door FURGONE 2X180° VAN 2X180°			

NISSAN - OPEL - RENAULT		PRIMASTAR - VIVARO - TRAFIC		
	02→14	FANALE POSTERIORE REAR LAMP	➔	5.44.136.00
		FANALE POSTERIORE REAR LAMP	➜	5.44.135.00
	PER VEICOLI CON 2 PORTE A BATTENTI - For vehicles with 2 swing doors Porta scorrevole a dx - For right sliding door FURGONE 2X180° VAN 2X180°			

NISSAN - OPEL - RENAULT		PRIMASTAR - VIVARO - TRAFIC	
	02→14	FANALE POSTERIORE REAR LAMP	➔ 5.44.138.00
		FANALE POSTERIORE REAR LAMP	➜ 5.44.139.00
	PER VEICOLI CON PORTELLONE - For vehicles with tailgate Senza porta scorrevole - Without sliding door Senza foro per cerniera - Without hinge hole		

NISSAN - OPEL - RENAULT		PRIMASTAR - VIVARO - TRAFIC	
	02→14	FANALE POSTERIORE REAR LAMP	➔ 5.44.140.00
		FANALE POSTERIORE REAR LAMP	➜ 5.44.141.00
	PER VEICOLI CON PORTELLONE - For vehicles with tailgate Con due porte scorrevoli - For 2 sliding door Senza foro per cerniera - Without hinge hole		

NISSAN - OPEL - RENAULT		PRIMASTAR - VIVARO - TRAFIC	
	02→14	FANALE POSTERIORE REAR LAMP	➔ 5.44.138.00
		FANALE POSTERIORE REAR LAMP	➜ 5.44.141.00
	PER VEICOLI CON PORTELLONE - For vehicles with tailgate Porta scorrevole a sx - For left sliding door Senza foro per cerniera - Without hinge hole		

NISSAN - OPEL - RENAULT		PRIMASTAR - VIVARO - TRAFIC	
	02→14	FANALE POSTERIORE REAR LAMP	➔ 5.44.140.00
		FANALE POSTERIORE REAR LAMP	➜ 5.44.139.00
	PER VEICOLI CON PORTELLONE - For vehicles with tailgate Porta scorrevole a dx - For right sliding door Senza foro per cerniera - Without hinge hole		

OPEL		MOVANO	
	03→09	GRUPPO OTTICO POSTERIORE REAR OPTIC. UNIT	➔ 2.44.318.10
		GRUPPO OTTICO POSTERIORE REAR OPTIC. UNIT	➜ 2.44.319.10
	* Ricambio di qualità equivalente Parts of matching quality		

PEUGEOT		PARTNER-BERLINGO	
	03→08	PROIETTORE CON MOTORINO HEADL. WITH ELEC. DEVICE	➔ 8.94.238.00
		PROIETTORE CON MOTORINO HEADL. WITH ELEC. DEVICE	➜ 8.94.239.00
	H4 - PY21W - W5W * Ricambio di qualità equivalente <i>Parts of matching quality</i>		

PEUGEOT		BIPPER-NEMO-FIORINO	
	08→	PROIETTORE CON MOTORINO HEADL. WITH ELEC. DEVICE	➔ 8.94.240.00
		PROIETTORE CON MOTORINO HEADL. WITH ELEC. DEVICE	➜ 8.94.241.00
	H4 - PY21W - W5W * Ricambio di qualità equivalente <i>Parts of matching quality</i>		

PORSCHE		CAYENNE		LED
	10→	FANALE LATERALE LED FLASHER LED	➔ 5.02.122.80	
		FANALE LATERALE LED FLASHER LED	➜ 5.02.123.80	

PORSCHE		PANAMERA		LED
	16→	FANALE LATERALE LED FLASHER LED	➔ 5.02.124.80	
		FANALE LATERALE LED FLASHER LED	➜ 5.02.125.80	

RENAULT		LAGUNA III	
	07→	FANALE LATERALE FLASHER	➔ 5.02.126.00
		FANALE LATERALE FLASHER	➜ 5.02.127.00

RENAULT		MASTER	
	04→10	PROIETTORE CON MOTORINO HEADL. WITH ELEC. DEVICE	➔ 8.94.242.00
		PROIETTORE CON MOTORINO HEADL. WITH ELEC. DEVICE	➜ 8.94.243.00
	H7 - H1 - W5W * Ricambio di qualità equivalente <i>Parts of matching quality</i>		

RENAULT		KANGOO	
	08→12	GRUPPO OTTICO POSTERIORE 1 PORTA REAR OPTIC. UNIT 1 DOOR	➔ 2.04.106.10
		GRUPPO OTTICO POSTERIORE 1 PORTA REAR OPTIC. UNIT 1 DOOR	➜ 2.04.107.10
	* Ricambio di qualità equivalente <i>Parts of matching quality</i>		

RENAULT		KANGOO	
	08→12	GRUPPO OTTICO POSTERIORE 2 PORTE REAR OPTIC. UNIT 2 DOORS	➔ 2.04.108.10
		GRUPPO OTTICO POSTERIORE 2 PORTE REAR OPTIC. UNIT 2 DOORS	➜ 2.04.109.10
	* Ricambio di qualità equivalente <i>Parts of matching quality</i>		

RENAULT		KANGOO	
	13→	GRUPPO OTTICO POSTERIORE 1 PORTA REAR OPTIC. UNIT 1 DOOR	➔ 2.04.110.10
		GRUPPO OTTICO POSTERIORE 1 PORTA REAR OPTIC. UNIT 1 DOOR	➜ 2.04.111.10
	* Ricambio di qualità equivalente <i>Parts of matching quality</i>		

RENAULT		KANGOO	
	13→	GRUPPO OTTICO POSTERIORE 2 PORTE REAR OPTIC. UNIT 2 DOORS	➔ 2.04.112.10
		GRUPPO OTTICO POSTERIORE 2 PORTE REAR OPTIC. UNIT 2 DOORS	➜ 2.04.113.10
	* Ricambio di qualità equivalente <i>Parts of matching quality</i>		

RENAULT	PREMIUM I-MIDLUM-KERAX		
	00→	LUCE INGOMBRO ANTERIORE SIDE LAMP	→ ← 2.41.326.00
		PORTALAMPADA BULB HOLDER	2.41.326.18
	R5W * Ricambio di qualità equivalente Parts of matching quality		

RENAULT	RANGE T		LED
	15→	INDICATORE DI DIREZIONE LED LED FRONT INDICATOR	→ 2.41.130.80
		INDICATORE DI DIREZIONE LED LED FRONT INDICATOR	← 2.41.131.80
	* Ricambio di qualità equivalente Parts of matching quality		

RENAULT	RANGE T		
	14→	FENDINEBBIA CON LAMPADA FOG LAMP WITH BULB	→ 8.94.212.00
		FENDINEBBIA CON LAMPADA FOG LAMP WITH BULB	← 8.94.213.00
	H11 * Ricambio di qualità equivalente Parts of matching quality		

RENAULT	RANGE T		LED
	14→	PROIETTORE DRL LED CON MOTORINO DRL HEADL. WITH ELEC. DEV.	→ 8.94.218.00
		PROIETTORE DRL LED CON MOTORINO DRL HEADL. WITH ELEC. DEV.	← 8.94.219.00
	H7 + H1 * Ricambio di qualità equivalente Parts of matching quality		

RENAULT	RANGE T		XENON
	14→	PROIETTORE XENON COMPLETO DI LAMPADA CON CENTRALINA CON DRL LED HEADLAMP XENON WITH BULB AND CONTROL UNIT LED DRL	→ 8.40.108.60
		PROIETTORE XENON COMPLETO DI LAMPADA CON CENTRALINA CON DRL LED HEADLAMP XENON WITH BULB AND CONTROL UNIT LED DRL	← 8.40.109.60
	H1-D1S		

SKODA		OCTAVIA II / SUPERB II (FINO15)	
	08→13	FANALE LATERALE FLASHER	→ 5.02.128.00
		FANALE LATERALE FLASHER	← 5.02.129.00

SKODA		OCTAVIA III		LED
	13→	FANALE LATERALE LED FLASHER LED	→ 5.02.130.80	
		FANALE LATERALE LED FLASHER LED	← 5.02.131.80	

SKODA		SUPERB III / KOMBI		LED
	15→	FANALE LATERALE LED FLASHER LED	→ 5.02.132.80	
		FANALE LATERALE LED FLASHER LED	← 5.02.133.80	



SKODA		YETI	
	09→12	FANALE LATERALE FLASHER	→ 5.02.134.00
		FANALE LATERALE FLASHER	← 5.02.135.00

SKODA		YETI	
	09→12	FANALE LATERALE CON LUCE DI CORTESIA FLASHER WITH COVER WITH COURTESY LIGHT	→ 5.02.136.00
		FANALE LATERALE CON LUCE DI CORTESIA FLASHER WITH COVER WITH COURTESY LIGHT	← 5.02.137.00

SKODA		YETI	
	09→17	FANALE LATERALE FLASHER	→ 5.02.138.00
		FANALE LATERALE FLASHER	← 5.02.139.00

TOYOTA		AURIS	
	06→12	FANALE LATERALE FLASHER	→ 5.02.140.00
		FANALE LATERALE FLASHER	← 5.02.141.00

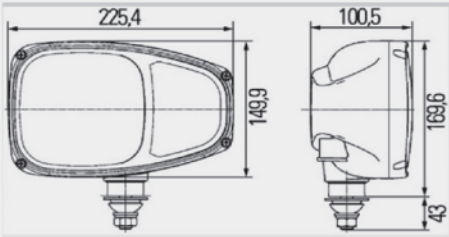
TOYOTA		YARIS	
	14→	FANALE LATERALE FLASHER	→ 5.02.142.00
		FANALE LATERALE FLASHER	← 5.02.143.00

TRACTOR		JBC 3CX-4CX	
		PROIETTORE HEADLAMP	→ 8.94.214.00
		PROIETTORE HEADLAMP	← 8.94.215.00
	17→	 	
		H7 - H3 - PY21W - T4W * Ricambio di qualità equivalente <i>Parts of matching quality</i>	

UNIVERSALE	RIMORCHI			
		FANALE POSTERIORE CON RETROMARCIA 5 FUNZIONI REAR REVERSE LAMP 5 FUNCT.	➔	2.44.298.00
		FANALE POSTERIORE CON RETROMARCIA 5 FUNZIONI REAR REVERSE LAMP 5 FUNCT.	➜	2.44.299.00
		TRASPARENTE POSTERIORE 5 FUNZIONI REAR LENS 5 FUNCT.	➔	2.44.298.20
		TRASPARENTE POSTERIORE 5 FUNZIONI REAR LENS 5 FUNCT.	➜	2.44.299.20
	R5W+P21W CON PASSACAVO WITH FAIRLEAD * Ricambio di qualità equivalente Parts of matching quality			

VOLKSWAGEN	CRAFTER			
		GRUPPO OTTICO POSTERIORE REAR OPTIC. UNIT	➔	2.44.302.10
	17➔	GRUPPO OTTICO POSTERIORE REAR OPTIC. UNIT	➜	2.44.303.10
	* Ricambio di qualità equivalente Parts of matching quality			

VOLKSWAGEN	TIGUAN	LED		
		FANALE LATERALE LED FLASHER LED	➔	5.02.146.80
	16➔	FANALE LATERALE LED FLASHER LED	➜	5.02.147.80

VOLKSWAGEN	TIGUAN	LED		
		FANALE LATERALE LED FLASHER LED	➔	5.02.148.80
	17➔	FANALE LATERALE LED FLASHER LED	➜	5.02.149.80







VOLKSWAGEN		TRANSPORTER T5	
	03→09	GRUPPO OTTICO POSTERIORE 1 PORTA REAR OPTIC. UNIT 1 DOOR	➔ 2.44.308.10
		GRUPPO OTTICO POSTERIORE 1 PORTA REAR OPTIC. UNIT 1 DOOR	➜ 2.44.309.10
	* Ricambio di qualità equivalente <i>Parts of matching quality</i>		

VOLKSWAGEN		TRANSPORTER T5	
	03→09	GRUPPO OTTICO POSTERIORE 2 PORTE REAR OPTIC. UNIT 2 DOORS	➔ 2.44.310.10
		GRUPPO OTTICO POSTERIORE 2 PORTE REAR OPTIC. UNIT 2 DOORS	➜ 2.44.311.10
	* Ricambio di qualità equivalente <i>Parts of matching quality</i>		

VOLKSWAGEN		TRANSPORTER T5	
	05→09	PROIETTORE CON MOTORINO HEADL. WITH ELEC. DEVICE	➔ 8.94.244.00
		PROIETTORE CON MOTORINO HEADL. WITH ELEC. DEVICE	➜ 8.94.245.00
	H4 - PY21W - W5W * Ricambio di qualità equivalente <i>Parts of matching quality</i>		

VOLKSWAGEN		TRANSPORTER T6		LED
	15→	FANALE POSTERIORE TRANSPORTER (T6) 1P REAR OPTIC. UNIT 1 DOOR	➔ 2.44.304.80	
		FANALE POSTERIORE TRANSPORTER (T6) 1P REAR OPTIC. UNIT 1 DOOR	➜ 2.44.305.80	
	* Ricambio di qualità equivalente <i>Parts of matching quality</i>			

VOLKSWAGEN		TRANSPORTER T6	
	15→	GRUPPO OTTICO POSTERIORE 2 PORTE REAR OPTIC. UNIT 2 DOORS	➔ 2.44.306.10
		GRUPPO OTTICO POSTERIORE 2 PORTE REAR OPTIC. UNIT 2 DOORS	➜ 2.44.307.10
	* Ricambio di qualità equivalente <i>Parts of matching quality</i>		

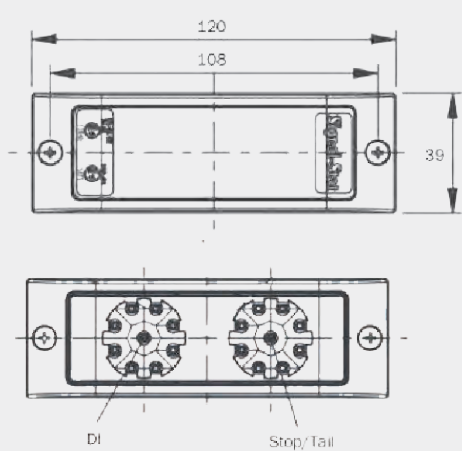
VOLVO		BUS-RENAULT-IVECO		LED
		FANALE LATERALE ARANCIO 4 LED SIDE LAMP	 	2.42.128.80
	* Ricambio di qualità equivalente <i>Parts of matching quality</i>			
VOLVO		XC90		LED
		FANALE LATERALE LED FLASHER LED		5.02.144.80
	14→	FANALE LATERALE LED FLASHER LED		5.02.145.80
UNIVERSALE				LED
		FANALE POSTERIORE 3 FUNZIONI LED POSIZIONE STOP DIREZIONE 3 FUNCTIONS REAR LAMPS LED PARKING STOP REPEATER		4.44.112.80
		FANALE POSTERIORE 2 FUNZIONI LED RETRONEBBIA RETROMARCIA 2 FUNCTIONS REAR LAMPS LED FOG LAMP REVERSING LAMP		4.44.113.80
				
		12 24 - MM120X39		

UNIVERSALE	BICI	LED
	<p>LUCE POSTERIORE LED BICI CON CAVO USB RESISTENTE ALL'ACQUA - DURATA 20h - VISIBILE A 200m</p> <p><i>ULTRA BRIGHT SMART BIKE REAR LIGHT, RECHARGEABLE, WATERPROOF LED - 20 HOURS DURATION - VISIBLE 200 METERS</i></p> <p>CON ACCELEROMETRO - ACCENSIONE AUTOMATICA DOPO FRENATA E REGOLAZIONE AUTOMATICA DELL'INTENSITÀ LUMINO. BRAKE SENSING, LIGHT SENSING, AUTO START/STOP, USB CHARGE, SADDLE MOUNT, SEATPOST MOUNT.</p>	<p>2.03.010.80</p>

RIFERIMENTI ORIGINALI ORIGINAL PARTS NUMBERS
AVVERTENZE PER LA CONSULTAZIONE

I riferimenti originali riportati nelle tabelle seguenti, sono forniti a mero titolo informativo ed il loro utilizzo nel presente catalogo ha l'unico scopo di aiutare e agevolare la corretta identificazione del modello di veicolo sul quale deve montarsi il pezzo di ricambio.

Si avverte, ad ogni fine, che la scelta dei prodotti deve essere determinata ed avvenire unicamente in base ai codici OLSA Parts riportati nelle parti illustrative del catalogo.

NOTES FOR CONSULTATION

The original references which are reported in the following tables are provided for information purposes only and their use in this catalogue must be intended only and just to help and facilitate the correct identification of the vehicle model on which the spare parts must be fitted to.

In any event, we warn that the choice of products must be determined only by and according to OLSA Parts references contained in the illustrated sections of this catalogue.

AUDI	OLSA Parts
4G8949101	5.02.104.80
4G8949102	5.02.105.80
81A949101	5.02.106.80
81A949102	5.02.107.80
BMW	OLSA Parts
63137171007	1.02.183.00
63137171008	1.02.182.00
63217311029	1.04.249.00
63217311030	1.04.248.00
63217311031	1.04.253.00
63217311032	1.04.252.00
63217311041	1.04.251.00
63217311042	1.04.250.00
63217311059	1.04.247.00
63217311060	1.04.246.00
63217350695	1.04.239.00
63217350696	1.04.238.00
63217350697	1.04.241.00
63217350698	1.04.240.00
63217350711	1.04.243.00
63217350712	1.04.242.00
63217350715	1.04.245.00
63217350716	1.04.244.00
63217359018	1.04.254.00
63217359018	1.04.255.00
63217359019	1.04.257.00
63217359020	1.04.256.00

DAF	OLSA Parts
1699300	8.94.203.00
1699301	8.94.202.00
1835874	8.94.201.00
1835875	8.94.200.00
FIAT	OLSA Parts
51984459	2.04.115.10
51984487	2.04.114.10
1340663080	8.94.220.00
1340664080	8.94.221.00
1368639080	8.94.222.00
1368641080	8.94.223.00
6000617811	2.44.294.10
6000617812	2.44.295.10
FORD	OLSA Parts
1346495	8.94.225.00
1346497	8.94.224.00
1545513	8.94.230.00
1545514	8.94.231.00
1828369	2.44.313.10
1828370	2.44.312.10
1846222	2.44.316.00
1846223	2.44.317.00
1867792	8.94.226.00
1867794	8.94.228.00
1867796	8.94.227.00
1867798	8.94.229.00
1877025	8.94.232.00

1877025	8.94.234.00
1877027	8.94.233.00
1877027	8.94.235.00
1908967	2.44.314.10
1908969	2.44.315.10
41221015	8.94.136.00
41221036	8.94.137.00
JBC	OLSA Parts
70050192	8.94.215.00
70050193	8.94.214.00
MERCEDES	OLSA Parts
6398200164	2.44.301.10
6398200264	2.44.300.10
9608200839	8.94.211.60
9608200939	8.94.210.60
A0008205064	2.44.296.00
A0008205064	2.44.297.00
A0999067101	5.02.113.80
A0999067201	5.02.112.80
A0999067301	5.02.115.80
A0999067401	5.02.114.80
A2038201321	5.02.117.00
A2038201421	5.02.116.00
A2048200721	5.02.111.80
A2048200821	5.02.110.80
A2198200521	5.02.119.00
A2198200621	5.02.118.00
A6398201861	8.94.237.00

A6398201961	8.94.236.00
A9608200439	8.94.209.00
A9608200539	8.94.208.00
A9608201021	2.42.095.00
A9608201121	2.42.094.00
A9608202239	8.94.217.00
A9608202339	8.94.216.00
A9678200121	2.41.133.00
A9678200221	2.41.132.00
A9678200321	2.41.133.80
A9678200421	2.41.132.80
MINI	OLSA Parts
63132751331	1.02.175.00
63132751332	1.02.174.00
63132751333	1.02.177.00
63132751334	1.02.176.00
63137298337	1.02.175.80
63137298338	1.02.174.80
63137298351	1.02.181.00
63137298352	1.02.180.00
63217297413	1.04.259.00
63217297414	1.04.258.00
63217297433	1.04.261.00
63217297434	1.04.260.00
63217297547	1.02.177.80
63217297548	1.02.176.80
63217352153	1.04.267.00
63217352154	1.04.266.00
63217352155	1.04.265.00
63217352156	1.04.264.00
63217352157	1.04.269.00
63217352158	1.04.268.00
63217435133	1.04.233.00
63217435134	1.04.232.00
63217435135	1.04.233.16
63217435136	1.04.232.16
63219477149	1.04.273.00
63219477150	1.04.272.00
63219477151	1.04.273.06

63219477152	1.04.272.06
63219477153	1.04.271.00
63219477154	1.04.270.00
63219477155	1.04.271.06
63219477156	1.04.270.06
63247350007	1.04.263.00
63247350008	1.04.262.00
NISSAN	OLSA Parts
8200336826	5.44.141.00
8200336830	5.44.140.00
8200336831	5.44.139.00
8200336832	5.44.138.00
8200336833	5.44.137.00
8200336834	5.44.136.00
8200336835	5.44.135.00
8200336836	5.44.134.00
8200336837	5.44.133.00
8200336839	5.44.132.00
8200336840	5.44.131.00
8200336841	5.44.130.00
26160BV80A	5.02.120.80
26165BV80A	5.02.121.80
OPEL	OLSA Parts
4413002	5.44.141.00
4413003	5.44.140.00
4413004	5.44.139.00
4413005	5.44.138.00
4413006	5.44.137.00
4413007	5.44.136.00
4413008	5.44.135.00
4413009	5.44.134.00
4413010	5.44.133.00
4413011	5.44.132.00
4413012	5.44.131.00
4413013	5.44.130.00
4401956	2.44.319.10
4401957	2.44.318.10
PEUGEOT	OLSA Parts
6205ZE	8.94.238.00

6204ZE	8.94.239.00
1353197080	8.94.240.00
1353198080	8.94.241.00
PORSCHE	OLSA Parts
95863110231	5.02.122.80
95863110131	5.02.123.80
971949102B	5.02.124.80
971949101B	5.02.125.80
RENAULT	OLSA Parts
5001834561	2.41.326.00
7482252914	8.94.213.00
7482252916	8.94.212.00
7482622149	2.41.130.80
7482622233	2.41.131.80
7482622237	8.40.108.60
7482622259	8.40.109.60
7482622272	8.94.218.00
7482622276	8.94.219.00
8200163516	8.94.243.00
8200163518	8.94.242.00
8200336826	5.44.141.00
8200336830	5.44.140.00
8200336831	5.44.139.00
8200336832	5.44.138.00
8200336833	5.44.137.00
8200336834	5.44.136.00
8200336835	5.44.135.00
8200336836	5.44.134.00
8200336837	5.44.133.00
8200336839	5.44.132.00
8200336840	5.44.131.00
8200336841	5.44.130.00
8200419941	2.04.107.10
8200419945	2.04.106.10
8200419949	2.04.109.10
8200419952	2.04.108.10
261650001R	5.02.126.00
261650002R	5.02.127.00
265506145R	2.04.110.10

265506747R	2.04.112.10
265557352R	2.04.111.10
265559212R	2.04.113.10
SKODA	OLSA <i>Parts</i>
3T0949102	5.02.128.00
3T0949101	5.02.129.00
5E0949102	5.02.130.80
5E0949101	5.02.131.80
3V0949102	5.02.132.80
3V0949101	5.02.133.80
5L0949102	5.02.134.00
5L0949101	5.02.135.00
5L0949102A	5.02.136.00
5L0949101A	5.02.137.00
5L0949102B	5.02.138.00
5L0949101B	5.02.139.00
TOYOTA	OLSA <i>Parts</i>
8173002110	5.02.140.00
817310D080	5.02.142.00
8174002020	5.02.141.00
817410D020	5.02.143.00
VOLKSWAGEN	OLSA <i>Parts</i>
0301191301	8.94.245.00
0301191302	8.94.244.00
5NA949101	5.02.147.80
5NA949101A	5.02.149.80
5NA949102	5.02.146.80
5NA949102A	5.02.148.80
7E0945095K	2.44.305.80
7E0945095T	2.44.307.10
7E0945096K	2.44.304.80
7E0945096T	2.44.306.10
7H0945095G	2.44.311.10
7H0945096G	2.44.310.10
7H5945095H	2.44.309.10
7H5945096H	2.44.308.10
VOLVO	OLSA <i>Parts</i>
31385685	5.02.145.80
31385686	5.02.144.80

INDICE PER CODICE *CODE INDEX*

CODICE/CODE	PAG.	CODICE/CODE	PAG.	CODICE/CODE	PAG.	CODICE/CODE	PAG.
1.02.174.00	14	1.04.258.00	13	2.41.133.80	10	5.02.104.80	4
1.02.174.80	14	1.04.259.00	13	2.41.326.00	21	5.02.105.80	4
1.02.175.00	14	1.04.260.00	13	2.41.326.18	21	5.02.106.80	4
1.02.175.80	14	1.04.261.00	13	2.42.094.00	10	5.02.107.80	4
1.02.176.00	14	1.04.262.00	14	2.42.095.00	10	5.02.110.80	10
1.02.176.80	14	1.04.263.00	14	2.42.128.80	26	5.02.111.80	10
1.02.177.00	14	1.04.264.00	12	2.44.294.10	7	5.02.112.80	11
1.02.177.80	14	1.04.265.00	12	2.44.295.10	7	5.02.113.80	11
1.02.180.00	13	1.04.266.00	13	2.44.296.00	11	5.02.114.80	11
1.02.181.00	13	1.04.267.00	13	2.44.297.00	11	5.02.115.80	11
1.02.182.00	6	1.04.268.00	13	2.44.298.00	24	5.02.116.00	11
1.02.183.00	6	1.04.269.00	13	2.44.298.20	24	5.02.117.00	11
1.04.232.00	15	1.04.270.00	15	2.44.299.00	24	5.02.118.00	11
1.04.232.16	16	1.04.270.06	15	2.44.299.20	24	5.02.119.00	11
1.04.233.00	15	1.04.271.00	15	2.44.300.10	12	5.02.120.80	16
1.04.233.16	16	1.04.271.06	15	2.44.301.10	12	5.02.121.80	16
1.04.238.00	5	1.04.272.00	15	2.44.302.10	24	5.02.122.80	19
1.04.239.00	5	1.04.272.06	15	2.44.303.10	24	5.02.123.80	19
1.04.240.00	5	1.04.273.00	15	2.44.304.80	25	5.02.124.80	19
1.04.241.00	5	1.04.273.06	15	2.44.305.80	25	5.02.125.80	19
1.04.242.00	6	2.03.010.80	27	2.44.306.10	25	5.02.126.00	19
1.04.243.00	6	2.04.106.10	20	2.44.307.10	25	5.02.127.00	19
1.04.244.00	6	2.04.107.10	20	2.44.308.10	25	5.02.128.00	22
1.04.245.00	6	2.04.108.10	20	2.44.309.10	25	5.02.129.00	22
1.04.246.00	4	2.04.109.10	20	2.44.310.10	25	5.02.130.80	22
1.04.247.00	4	2.04.110.10	20	2.44.311.10	25	5.02.131.80	22
1.04.248.00	5	2.04.111.10	20	2.44.312.10	8	5.02.132.80	22
1.04.249.00	5	2.04.112.10	20	2.44.313.10	8	5.02.133.80	22
1.04.250.00	5	2.04.113.10	20	2.44.314.10	8	5.02.134.00	22
1.04.251.00	5	2.04.114.10	7	2.44.315.10	8	5.02.135.00	22
1.04.252.00	5	2.04.115.10	7	2.44.316.00	8	5.02.136.00	22
1.04.253.00	5	2.41.130.80	21	2.44.317.00	8	5.02.137.00	22
1.04.254.00	4	2.41.131.80	21	2.44.318.10	18	5.02.138.00	23
1.04.255.00	4	2.41.132.00	10	2.44.319.10	18	5.02.139.00	23
1.04.256.00	4	2.41.132.80	10	4.44.112.80	26	5.02.140.00	23
1.04.257.00	4	2.41.133.00	10	4.44.113.80	26	5.02.141.00	23

CODICE/CODE	PAG.	CODICE/CODE	PAG.
5.02.142.00	23	8.94.216.00	10
5.02.143.00	23	8.94.217.00	10
5.02.144.80	26	8.94.218.00	21
5.02.145.80	26	8.94.219.00	21
5.02.146.80	24	8.94.220.00	7
5.02.147.80	24	8.94.221.00	7
5.02.148.80	24	8.94.222.00	7
5.02.149.80	24	8.94.223.00	7
5.44.130.00	16	8.94.224.00	8
5.44.131.00	16	8.94.224.00	25
5.44.132.00	16	8.94.225.00	8
5.44.133.00	16	8.94.225.00	25
5.44.134.00	17	8.94.226.00	8
5.44.135.00	17	8.94.227.00	8
5.44.136.00	17	8.94.228.00	9
5.44.137.00	17	8.94.229.00	9
5.44.138.00	18	8.94.230.00	9
5.44.139.00	18	8.94.231.00	9
5.44.140.00	18	8.94.232.00	9
5.44.141.00	18	8.94.233.00	9
8.20.066.00	7	8.94.234.00	9
8.20.067.00	7	8.94.235.00	9
8.40.108.60	21	8.94.236.00	12
8.40.109.60	21	8.94.237.00	12
8.94.136.00	9	8.94.238.00	19
8.94.137.00	9	8.94.239.00	19
8.94.200.00	6	8.94.240.00	19
8.94.201.00	6	8.94.241.00	19
8.94.202.00	6	8.94.242.00	20
8.94.203.00	6	8.94.243.00	20
8.94.208.00	12	8.94.244.00	25
8.94.209.00	12	8.94.245.00	25
8.94.210.60	12		
8.94.211.60	12		
8.94.212.00	21		
8.94.213.00	21		
8.94.214.00	23		
8.94.215.00	23		

NOTE

NOTE

CONDIZIONI GENERALI DI VENDITA

1. Le presenti Condizioni Generali di Vendita si applicano a tutti gli ordini accettati da OLSA Parts s.r.l. (di seguito anche "OLSA") Condizioni difformi da quelle riportate saranno valide solo se redatte in forma scritta.
2. La conferma degli ordini ricevuti da OLSA potrà avvenire, entro il termine massimo di 60 giorni dalla ricezione dell'ordine medesimo, tramite accettazione tacita - cioè mediante invio diretto al cliente della merce oggetto dell'ordine - oppure tramite accettazione scritta.
3. Le condizioni di resa sono regolate secondo quanto previsto dagli accordi tra OLSA ed i suoi Clienti, e riepilogate nei documenti di trasporto emessi da OLSA.
4. Eventuali manomissioni e/o effrazioni dei colli ricevuti dovranno essere contestate direttamente al corriere, al momento del ritiro della merce.
5. Ogni reclamo inerente alla quantità della merce ricevuta o alla non corrispondenza della stessa con l'ordine dovrà esserci comunicato via PEC o raccomandata a/r entro e non oltre 8 giorni dalla data del ritiro della merce, anticipando via mail o fax tale comunicazione entro il medesimo termine in caso di raccomandata a/r. Se la differenza tra ordine e spedizione risulta essere causata da un errore di ordinazione imputabile al cliente, verrà ad esso addebitato il 20% del valore della merce resa per costi di ripristino magazzino.
6. Ogni reclamo inerente alla qualità della merce dovrà esserci trasmesso non appena riscontrato, in ogni caso non oltre la fine dell'anno solare nel quale la merce è stata ricevuta.
7. Con riferimento ai punti 5 e 6, verranno respinti resi di materiale non preventivamente autorizzati, e quindi nessuna sostituzione del materiale potrà essere effettuata se non prima concordata con i nostri uffici.
8. Per quanto riguarda i difetti soggetti alle garanzie legali di conformità, è fatto salvo quanto previsto dalla legge.
9. I prezzi di listino possono essere soggetti a variazioni e sconti anche in dipendenza di azioni promozionali ed operazioni speciali.
10. Il pagamento deve avvenire nei termini e nelle forme pattuite e per l'intero importo della fattura.
11. In caso di mancato pagamento e/o grave ritardo nell'effettuazione dello stesso, OLSA si riserva il diritto di agire in giudizio senza previa necessità di messa in mora per il recupero di quanto a lei spettante, comprensivo di ogni accessorio di legge.
12. È vietata la riproduzione, anche parziale, del contenuto del presente catalogo senza preventiva autorizzazione scritta di OLSA.
13. OLSA ha curato con particolare attenzione la stesura del presente catalogo; declina comunque ogni responsabilità per eventuali errori di immagini, disegni, corrispondenze con codici O.E. e si riserva il diritto di apportare modifiche al contenuto senza obbligo di preavviso.
14. Per qualsiasi controversia unico foro competente in via esclusiva sarà quello di Torino.

GENERAL SALES CONDITIONS TERMS

1. The following General Sale Conditions are applicable to all orders accepted by OLSA Parts s.r.l. (hereby also referred to as "OLSA"). Different conditions are deemed applicable only if in written form.
2. Confirmation of orders received by OLSA shall be made, within a maximum of 60 days from the receipt of the order, by tacit acceptance - that is, through delivery to the customer of the goods object of the order - or by written acceptance.
3. The delivery conditions are regulated in accordance with the agreements between OLSA and its customers and summarized in the transport documents issued by OLSA.
4. Tampering and/or break-ins of packages received must be challenged directly to the carrier at the time of receipt of the goods.
5. Any claim related to the quantity of the goods received or to the non-correspondence of the goods with the purchase order must be communicated via PEC or registered letter (with receipt) within 8 days from the date of receipt of goods, anticipating by e-mail or fax the notice, within the same timeframe in case of registered letter. If the difference between order and shipment results to be caused by a mistake of ordering due to the customer, OLSA will charge 20% of the value of goods delivered for costs of warehouse recovery.
6. Any complaint concerning the quality of goods must be sent when the defect is discovered, and in any case no later than the end of the calendar year in which the goods have been received.
7. With reference to paragraphs 5 and 6, returns of goods not previously authorized will be rejected, and therefore no substitution of goods shall be made if not previously agreed with our offices.
8. With regards to defects subject to legal guarantees of conformity, the governing law shall prevail.
9. Price lists can be subject to variations and discounts depending on promotional activities and special operations.
10. Payments must be made within the time limits and in the forms agreed and for the full amount of the invoices.
11. In the event of non-payment and/or delay in the payment itself, OLSA reserves the right to take legal action without the express need for formal notice for recovery of the due amount, to be inclusive of all accessories provided by the law.
12. It is forbidden to reproduce, even partially, the contents of this catalogue without prior written permission of OLSA.
13. OLSA has drafted this catalogue with the necessary required attention; OLSA declines all responsibility for any errors of images, drawings, correspondence with O.E. codes and reserves the right to make changes in the content without obligation of notification.
14. Exclusive jurisdiction for any disputes shall be the Court of Turin.

Tutti i prodotti Automotive VOSLA soddisfano i requisiti ECE e DOT, che in tutto il mondo rappresentano gli standard universali ed altamente tecnici dell'industria automobilistica.



vosla

GERMAN LIGHTING



Grazie ad una continua innovazione e sviluppo, VOSLA ha per qualsiasi applicazione la soluzione giusta; dalla convenzionale all'alogena da 12V e 24V.

DISTRIBUTORE ITALIA:

Olsa Parts srl C.so Allamano 70, 10098 RIVOLI (TO)
Tel. +39 011 6474394 Fax. +39 011 95 04 107
vendite@magna.com www.olsaparts.it

OLSA Parts



OLSA *Parts*

OLSA PARTS S.r.l.

Corso C. Allamano, 70
10098 Rivoli - Torino (IT)

Tel. +39 011.647.43.94

Fax +39 011. 647.43.95 | 011. 950.41.07

e-mail: vendite@magna.com

www.olsaparts.it

